

SENCOR®

SHC XD011



USER'S MANUAL

NÁVOD K OBSLUZE

NÁVOD NA OBSLUHU

FELHASZNÁLÓI KÉZIKÖNYV

INSTRUKCJA OBSŁUGI

РУКОВОДСТВО ПОЛЬЗОВАТЕЛЯ

NAUDOTOJO VADOVAS

DVD MIDRO SYSTEM

MIKROSYSTEM S DVD

MIKROSYSTEM S DVD

DVD MIKRORENDSZER

MIKROWIEŻA Z ODTWARZACZEM DVD

МИКРОСИСТЕМА С DVD

DVD MIKROSISTEMA

EN CZ SK HU PL RU LT

CONTENT

Important Safety Precautions	2
Features	6
Package Contents	6
Playable Discs and Media Types	6
Description	8
Front panel	8
Rear panel	8
Top panel	8
Remote control	9
DVD mode	9
Tuner mode	9
Using of remote control	9
Connections	10
Video system connection	10
Audio system connection	11
Basic operation	12
DVD discs	12
Tuner	13
System Setup	14
Menu operation	14
1 GENERAL Setup Page	14
2 AUDIO Setup Page	15
3 DOLBY DIGITAL Setup	15
4 VIDEO Setup Page	15
5 PREFERENCE Setup Page	16
CD ripping	17
KODAK CD Picture Playback	18
MP3 / MPEG4 Playback	18
USB Playback	18
Trouble shooting	19
Technical specifications	20

IMPORTANT SAFETY NOTICE

Read the entire user's manual before installing, turning on and setting up the device. It contains important information for the optimal and safe operation of all the features and functions. Keep the user's manual in case of future need. Pay attention to instructions, notes and recommendations in the user's manual and follow them.

Water and humidity

Do not install the system in a location, where it could be sprayed or poured over with water or another liquid. Do not use the device in the vicinity of sources of water and humidity, such as baths, washbasins, kitchen sinks or washing machines; in humid basements or in the vicinity of swimming pools and similar areas. If water does condensate, take out the disk, connect the power cord into the power socket, turn on the device and leave it on for 2 to 3 hours. During this time the device will heat up and the humidity will evaporate.

Placement

Never place this device on an unstable area, stand, cart, wall mount console, shelf or table. The device could fall and become damaged or lead to serious injury to people or household pets.

Any mounting of the device should be carried out according to the manufacturer's instructions and the mounting accessories recommended by the manufacturer should be used.

After placing the device on a cart, it is necessary to handle the cart with care. Stopping suddenly, excessive force and uneven surfaces could cause the cart to fall over with the device.

Accessories

Use only accessories supplied with the device. Under no condition should you use accessories other than those recommended by the manufacturer.

Ventilation

The cut outs and openings in the case of the device enable correct ventilation for reliable operation of your device and protection against overheating. These openings should never be blocked by the placement of the device on a bed, sofa, rug or other similar surface. If sufficient ventilation is not provided, the device should not be installed into built-in locations, such as for example a bookcase or shelf. Never place this device in the vicinity of heat sources, such as for example heating elements, fire stoves, heaters or other heat sources.

Heat

Do not install the device in the vicinity of any kind of heat source such as heaters, cookers or other devices (including amplifiers), which produce heat. Do not expose the device to the effects of direct sunlight.

Moving

Before moving the device installed on a movable table first disconnect all cables from the unit. While moving watch out for sudden changes in direction or speed (stopping) of the table – risk of the unit falling, injury to people, damage of the device and/or damage to other property.

Power source

Protection of the power cord - power cords should be placed so that they cannot be stepped on and that there are no objects located underneath them. Increased attention should be paid to cables at the plug, socket and locations where the cables enter the device.

Power lines - The outdoor antenna system should not be located in the vicinity of outdoor power lines or other electric lighting or power lines or in such locations where the fall of the antenna system into such a power line or circuit could occur.

Before installation check that the voltage on the type label matches the voltage in your power socket. When installing an outdoor antenna system you should be particularly careful and not touch electrical lines or circuits so as to prevent serious injury by electrical shock.

If you will not be using the system for a longer period of time, disconnect the main unit from the power grid. Do not disconnect the power cord plug of the device from the power socket by pulling on the power cord. There is a danger that the wires in the cable could become damaged or that the power socket could be torn out of the wall. When disconnecting the power cord hold the cord by the plug.

Electric power sources --- This device must only be power by power sources stated on the type label. If you are not certain about the specifications of the power sources in your home, contact your retailer or a local energy company. Devices designed for battery operation or other power sources - see operating instructions. This device operates under alternate current 100 – 240 V ~ 50/60 Hz. Do not turn off the device immediately after turning it on, wait at least 10 seconds.

Storm

To increase the protection of the device during a storm or in the case that you need to leave the device for a longer time without supervision or will not be using it for a long time, disconnect the device from the power socket and/or disconnect the antenna or the cable system. This will prevent the possible damage of the device resulting from atmospheric electricity (lightning) and peak currents.

Cleaning

Before cleaning the main unit, turn it off and disconnect it from the power supply. To clean the case of the main unit and its panels do not use liquid cleaning agents or sprays – use a clean soft cloth lightly dipped in a weak lukewarm solution of mild detergent. Then wipe the case with a wet cloth and wipe dry.

Repairs

Under no condition should you repair the device yourself. The device does not include parts, which the user can repair themselves. By opening or removing the cover you can expose yourself to dangerous voltage or other dangers. All repairs or tuning of the device should be carried out by an authorised service centre. In the following cases, disconnect the device from the power grid and do not use it until you receive the results from the inspection of the device by the employees of the professional service centre.

- damage of the power cord or power plug.
- if the device does not function according to the user's manual. To control the device use the control elements described in the user's manual. The use of other control elements may lead to dangerous situations or damage of the device.
- if the device fell or was damaged in any other way.
- if the device does not function properly or exhibits significant changes in its features and performance.
- if a foreign object or any kind of liquid entered the case of the device.
- if the device was left in the rain, was sprayed or something was poured on to it.

Spare parts

If it is necessary to replace some parts, ensure that the service technician uses spare parts specified by the manufacturer or that the spare parts have the same properties as the original parts. Unauthorised spare parts could cause a fire, lead to a danger of injury by electrical shock or other dangers.

Overloading

Do not overload the wall sockets, extension cords or integrated socket blocks, because this could lead to injury by electrical shock or a fire.

Protection of the electric cord

Protect the electric cord against damage. Lead the cord in such a way that it is not stepped on, do not place heavy objects on the cable. Pay attention to the cord near the power plug and where the cord exits the main unit.

Entry of foreign items or liquids

Never insert any foreign items into this device through any openings because they could come into contact with live parts of the device and cause a short circuit, which could cause a fire or injury by electrical shock.

Otherwise immediately turn off the device, disconnect the device from the power socket and contact an authorised service centre. Under no condition should you repair the device yourself or use the device. Protect the device from liquids being poured on it.

FOR SAFE OPERATION



The lightning symbol located in a frame formed by an equilateral triangle informs the user about the presence of an uninsulated "dangerous voltage" inside the device, which can have such an intensity as to cause injury by electrical shock.



The exclamation mark symbol located inside an equilateral triangle informs the user about important instructions for operation and maintenance (service), which are found in the attached device documentation.

The DVD player in a low power integrated class 1 laser beam. Do not remove the player from the device, do not turn the player on when it is out of the device - after unblocking the protection and switching on the player there is risk of permanent eye damage.

WARNING:

TO PREVENT A FIRE HAZARD OR INJURY BY ELECTRICAL SHOCK, DO NOT EXPOSE THIS DEVICE TO RAIN OR HUMIDITY. NEVER OPEN THE CASE OF THE DEVICE, THERE IS HIGH VOLTAGE INSIDE. THE CASE OF THE DEVICE MAY ONLY BE OPENED BY A QUALIFIED SERVICE TECHNICIAN.

ATTENTION:

TO PREVENT INJURY BY ELECTRICAL SHOCK, INSERT FULLY THE WIDE FORK OF THE PLUG INTO THE WIDE SOCKET.



ATTENTION:

This DVD receiver uses a laser system. To prevent being exposed to the effects of a laser beam, do not open the case of the device. When opened, visible radiation is caused. DO NOT EXPOSE YOURSELF TO THE EFFECTS OF THE BEAM. When using the control elements or carrying out settings and procedures, which are not included in this user's manual you may be exposed to dangerous laser radiation.

Before using the product please carefully read this user's guide and keep it for future use. If repairs are necessary contact an authorised service centre.

PROTECT YOURSELF!

Record the model number and the serial number of the device. These numbers are located on the back side of the case of the device.

Store this information for future use.

Model number

Serial number _____

Store this information for future use.

⚠ CAUTION

RISK OF ELECTRICAL SHOCK - DO NOT OPEN



CAUTION

⚠ THE POWER PLUG IS USED AS A DISCONNECTING DEVICE, WHICH MUST FOR THIS REASON REMAIN EASILY ACCESSIBLE.

- ⚠ TO REDUCE THE RISK OF INJURY BY ELECTRICAL SHOCK, DO NOT OPEN THE COVER OF THE DEVICE (OR ITS BACK PART). THERE ARE NOT ANY COMPONENTS IN THE DEVICE, WHICH THE USER CAN REPAIR HIMSELF. LEAVE ALL REPAIRS TO A QUALIFIED SERVICE CENTRE.
- ⚠ DO NOT EXPOSE THE DEVICE TO THE EFFECTS OF DRIPPING OR SPRAYING WATER AND DO NOT PLACE OBJECTS FILLED WITH A LIQUID (E.G. VASES) ON THE DEVICE.
- ⚠ THE DEVICE'S CONNECTOR IS USED AS A DISCONNECTING DEVICE, WHICH MUST FOR THIS REASON REMAIN EASILY ACCESSIBLE.
- ⚠ REMEMBER TO ALWAYS DISCONNECT THE POWER PLUG FROM THE POWER SOCKET BEFORE DISCONNECTING THE POWER CABLE FROM THE BACK SIDE OF THE DEVICE.
- ⚠ AN OPEN FLAME MUST NOT BE PLACED ON THE DEVICE, E.G. BURNING CANDLE.
- ⚠ PAY SPECIAL ATTENTION TO THE BATTERIES USED AS REGARDS TO THE ENVIRONMENT.
- ⚠ VENTILATION MUST NOT BE IMPEDED BY COVERING THE VENTILATION OPENINGS WITH OBJECTS SUCH AS NEWSPAPERS, TABLECLOTHS, CURTAINS, ETC.

Do not place any items on the main unit – they may cause discs to overheat or damage the player.

About this user's manual

- When installing, setting up and using the device follow the instructions in the user's manual and on the device.
- The control elements of the device are shown in the user's manual with CAPITAL LETTERS, for menu texts and displayed messages on the display of the device (i.e. on the used television) a bold font is used in the manual.
- The operation of the device is described in the user's manual by use of a remote control, the functions of which can likewise be operated using buttons on the device.

For safe use of the laser emitter

The DVD Player integrated in the device uses a low power laser emitter. For its safe use follow the following instructions:

1. Every time before the disk drive is opened check that the device is turned off.
2. Do not disassemble the device, do not remove the player from the device.
3. Under no circumstances repair the device yourself – should the device require tuning or repairs contact a person with the relevant qualifications, i.e. contact a professional service centre.
4. After removing the player from the case of the device, unblocking of protection and turning on the player there is a risk of permanent eye damage. During standard use of the player according to the instructions in the user's manual the player does not present any risks even for its direct vicinity.
5. The use of procedures and control elements other than those mentioned in the user's manual exposes you to risks of health damage by damaging laser radiation.

This item incorporates copy protection technology that is protected by U.S. patents and other intellectual property rights of Rovi Corporation. Reverse engineering and disassembly are prohibited.

POWER SUPPLY

CAUTION

- The device is designed to be powered by AC voltage 100 – 240 V ~ 50/60 Hz from the power grid. The voltage in the electrical grid in the installation location of the system is stated for example on the label of the electricity power meter. Do not use a voltage different to the one here stated to power the device.
- To connect the device to the electricity power grid insert the power cord plug into a properly installed power socket. If you have any doubts about the correct installation of the power socket, do not use the socket and contact a professional company.
- If any unusual events occur during the operation of the device (such as interruption to the sound, light indicators turning off, presence of a characteristic smell of burning insulation or even smoke) immediately turn off the device, disconnect from the power grid and before using the device again wait for the results from the inspection by a person with relevant qualifications.
- As the power cord has a safety function (quick disconnection of the device from the power grid) ensure that there is constant access to the used power socket.
- Protect the power cord against damage, do not make any modifications to the power cord. Do not excessively stretch or twist the power cord.
- Do not lead the power cord over sharp edges or near hot items. Do not touch the power cable and the plug with wet hands, there is a risk of injury by electrical shock or a fire hazard.

Features

Thank you for purchasing this product. Please read this manual thoroughly before assembling, connecting and using the device. Keep the manual in safe place for future reference.







- Built-in Dolby Digital, MPEG, LPCM, PCM etc. digital audio decoders.
- HI-FI, 96 kHz / 24bit audio digital processor.
- Software upgrade.
- Coaxial digital audio output.
- Compatible with DVD, DVD-R, DVD+R, DVD-RW, DVD+RW, VCD, DVCD, CD, CD-R, MP3, MPEG4, DivX, KODAK PICTURE CD, etc.
- USB slot
- High integrated servo system, decoding on single-chip technology, high reliability and stability, and super error correction.
- Full function remote control
- FM stereo radio tuner
- High quality amplifier
- CD ripping function

Package contents

After unpacking the device, please check it contains the following accessories:

- Instruction manual
- Remote control
- A/V cable
- FM antenna
- Speaker cable

Playable discs and Media Types

Disc Type	Symbol	Content
DVD		Audio + Video
MP3		Audio
Video-CD (VCD)		Audio + Video
CD-DA		Audio
Picture CD		JPEG photo CD
Kodak Picture CD		Electronic Photo
MPEG4		Audio + Video

Playing of disc types not mentioned here is not guaranteed.

Notes about discs

Handling discs

- Do not touch the surface of the disc where there is no label and where the recording is stored. When handling the disc, hold it by its edges, or by the edge and the centre disc opening. Do not stick labels on to the discs - to label a disc use soft tip markers specially designed for this purpose, mark the side of the disc with the label.
- After playback return the disc into its cover, where it is protected against scratching. Do not leave discs in direct sunlight or near a heat source, do not leave discs in closed motor vehicles parked in direct sunlight. Risk of deformation of the disc.



Cleaning of discs

- Fingerprints and dust affect the quality of the image while playing the recording from the disc. To remove this before playing the disc, clean with a soft lint-free cloth. When cleaning a disc proceed from the centre of the disc directly towards the edge (not using circular motion).
- For cleaning, do not use anti-static sprays for vinyl records, petrol, spirits or other solvents or thinners.

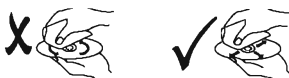

Notes:

1. Depending on the recording media, recording method (used PC program used for the disc recording) and its finalisation, it is possible that it will not be possible to play some CD-R or DVD+/-RW/R discs.
2. Do not attach any seal or label to either side (the labeled side or the recorded side) of a disc.
3. Use the player to play only circular discs - when playing irregular shaped discs there is a risk of damaging the disc or the player.
4. Some playback operations of DVDs and Video CDs may be intentionally programmed by software manufacturers. This unit plays DVDS and Video CDs according to disc content designed by the software manufacturer, therefore some playback features may not be available or other functions may be added.

Region code

This DVD player is designed and manufactured for playback of region „2“ encoded DVD software. This unit can play only DVD discs labeled „2“ or „ALL“.



Notes on Region Codes

Most DVD discs have a globe with one or more numbers in it clearly visible on the cover. This number must match your DVD player's region code on the back side of the player – otherwise the disc cannot play. If you try to play a DVD with a different region code from your player, the message „Check region Code“ appears on the TV screen.

Description

Front panel

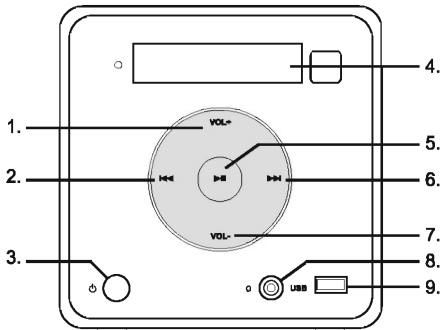

1. **VOL +** button: to increase the volume
2. **◀◀** button: previous track / chapter
3. **⏻** **STANDBY** button: power button / standby mode
4. Display
5. **▶▶** button: play / pause
6. **▶▶** button: next track / chapter
7. **VOL-** button: to decrease the volume
8. **🎧** output: to connect the earphones / headphones
9. USB slot: to connect USB memory device

Rear panel

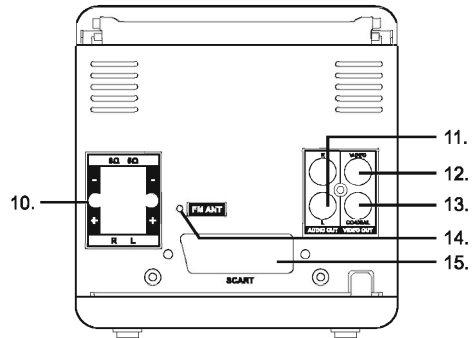

10. Speaker output L/R
11. Audio output L/R
12. Composite video output
13. Coaxial digital audio output
14. FM antenna jack
15. SCART output

Top panel

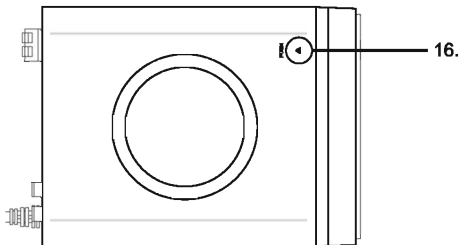

16. **▲** button: to open the cover of disc compartment

Important Caution

Listen with earphones / headphones

Connect earphones / headphones to the headphone jack with the volume set low and increase it if required. When earphones / headphones are connected, no sound will be emitted from the connected speaker system.



Warning

Excessive sound pressure from earphones / headphones can cause hearing loss.

Remote Control

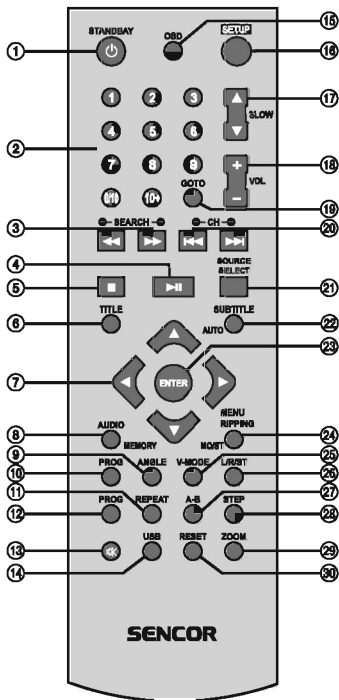

DVD Mode

1. **STANDBY** button
2. Numeric buttons
3. **▶▶ / ◀◀** buttons
4. **▶||** button
5. **■** button
6. **TITLE** button
7. Direction buttons **▲ / ▶ / ▼ / ◀**
8. **AUDIO** button
9. **ANGLE** button
10. **PROG** button
11. **REPEAT** button
12. **PROGRAM** button
13. **⊗** button
14. **USB** button
15. **OSD** button
16. Setup button
17. **SLOW ▲ / ▼** buttons
18. **VOL +/-** buttons
19. **GOTO** button
20. **◀◀ / ▶▶** buttons
21. **SOURCE SELECT** button
22. **SUBTITLE** button
23. **ENTER** button
24. **MENU / RIPPING** button
25. **V-MODE** button
26. **L/R/ST** button
27. **A-B REPEAT** button
28. **STEP** button
29. **ZOOM** button
30. **RESET** button

Tuner mode

3. **SEARCH +/-** buttons
8. **MEMORY** button
20. **CHANNEL +/-** buttons
21. **SOURCE SELECT** button
22. **AUTO** button
24. **MONO/STEREO** button

Using the remote control

Changing batteries

1. Remove the battery compartment cover on the back of the remote control.
2. Insert 2 x 1,5V batteries AAA types in the remote control. Make sure you have inserted the batteries correctly according to the polarity symbols – as indicated inside the battery compartment.
3. Replace the cover.

Notes:

To control the device using the remote control point the remote control at the device and then press the button with the required function. The maximum range of the remote control is about 5 meters with a deviation of up to +/- 30° from the perpendicular direction to the reception sensor of the remote control on the front side of the device. The falling capacity of the batteries gradually reduces the remote control range.

There must be no solid obstacles in the area between the remote control and the device when the remote control is being used. During standard use the lifetime of batteries in the remote control is about 1 year. When the effective ranges of the remote control is substantially reduced or when there are problems with its use, change both the batteries in the remote control.

If you do not be using the remote control for a longer period of time, take out both batteries from it - in this way you will prevent potential damage caused by their leakage.

Pay special attention to the batteries used as regards to the environment. The batteries must not be exposed to excessive heat, such as sun radiation, fire, etc. The incorrect use of batteries may cause the leakage of the electrolyte and corrosion. To ensure that the remote control works correctly, proceed according to the instructions below:

- Do not insert the batteries in the wrong direction.
- Do not recharge, heat, open or short the batteries.
- Do not throw batteries into a fire.
- Do not leave discharged batteries in the remote control.
- Do not combine various types of batteries or new and old batteries.
- If you are not using the remote control for a longer period of time, remove the batteries to prevent potential damage caused by a subsequent battery leakage.
- If the remote control is not working correctly or its operational range is reduced, change all batteries for new ones.
- If electrolyte leaks out from the batteries, have the remote control cleaned by an authorised service centre.

Connections

Video system connection

This device has been provided with the following video outputs:

- **Composite video output**
Use the cable with yellow plug of an AV cable to connect the composite video output of this unit to the video input of a TV / monitor.
- **SCART**
Use a SCART cable to connect the SCART output of this unit to a TV / monitor SCART input.

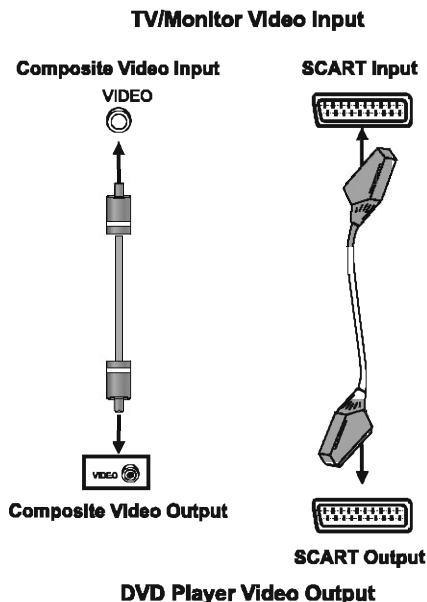

Notes:

- SCART is the best according to the video outputs above, however composite video connection is a standard one. Use the video connections which complies your requirements.
- Do not make both connections at the same time. Otherwise you may risk of damage of the connected devices.
- Only if the video connection conforms to the correct connection does the device produce the corresponding video output. Follow the instructions in Video Setup Page chapter, in System Setup.

Audio system connection

This device has been provided with the following audio output systems. There are an analogue audio output system and a digital audio output system.

The analogue audio output system includes 2-channel stereo output. The digital audio output system includes coaxial output.

- **Stereo Audio**

Use a pair of audio cables (white for left, red for right) to connect the stereo audio outputs of this unit to the stereo outputs of a TV or a power amplifier.

- **Coaxial digital audio**

Use a coaxial cable to connect the coaxial output of this unit to the coaxial input of a power amplifier.

- **Speaker output**

Connect the speakers to speaker output terminals with their supplied speaker cables (white for „+“, black for „-“).

TV/Monitor/Amplifier Audio Input

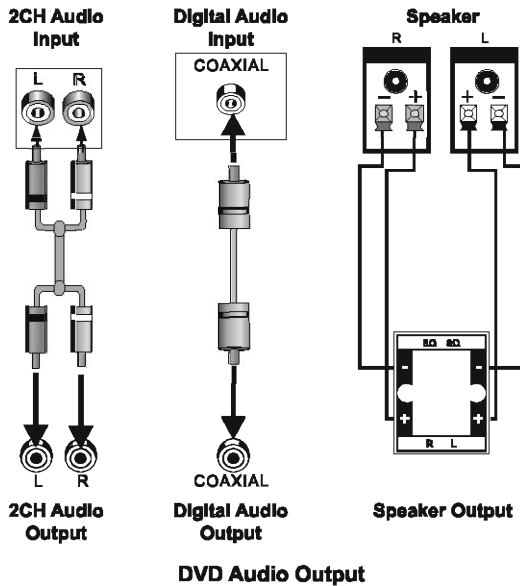

Note:

The audio setting should conform to the practical audio system connections. For more information please follow the **Audio Setup Page** in **System Setup** menu.

Basic operation

DVD discs

STANDBY



Press this button once to turn on the device. Press it again to switch to the standby mode.

RESET



When the disc compartment cover is opened, press this button to restore the default factory setting, except Parental setting and Password Setup.

SETUP



Press this button to enter / exit the menu.

V-MODE



Press this button repeatedly to choose the video output mode.

USB



Press this button repeatedly to choose the signal source of USB or DVD mode.



Numeric buttons are used for direct number input or to choose a track / chapter etc.





Press this button to enter the menu item or to confirm your selection.



Navigation buttons are used to move a cursor in the menus.



Press this button once to stop playing. Press  button to restore the playing from the stopped place. If you press this button twice, the playback will be stopped completely and pressing  button, you start play back from the beginning.



Press this button to pause playback. Press it again to restore the playback. Or press this button to resume normal playback from fast rewind mode, fast forward mode, frame-by-frame mode or slow playback mode etc.



Press this button for fast forward playback. You can choose from: 2x, 4x, 8x, 16x a 32x.



Press this button for fast rewind playback. You can choose from: 2x, 4x, 8x, 16x a 32x.



Press this button to skip to the next chapter / track.



Press this button to skip to previous chapter / track.

SUBTITLE



Press this button repeatedly to turn in / off subtitle function. (Note: This function is available only if the inserted discs are encoded with subtitles.)

OSD



Press this button repeatedly to show / hide the relative information of the playing disc.

PBC

















Press this button to activate / disable PBC function. When playing a disc with PBC function, press this button to display the PBC menu. Press it again to disable this function. (Note: This function is available only if the inserted disc is encoded with this function. The discs as VCD 2.0, DVD, VCD 1,1 a CD-DA discs do not contain PBC function.)

MENU









Press this button to enter the main menu.

	Press this button to enter the title menu of playable DVD disc.
	Press this button to enter GOTO menu. Using the numeric buttons, choose a title, chapter, track, time of track or time on the disc. Press it again to exit the GOTO menu.
	Press VOLUME + button to increase the volume or VOLUME – button to decrease the volume.
	Press this button to temporarily switch off the sound. Press it again to resume the original volume.
	Press this button repeatedly to switch to the available sound channel (Left Mono, Right Mono, Mix-Mono and STEREO) which are available on the disc.
	Press this button to switch between DVD and tuner modes.
	Press this button to enter / exit the CD ripping menu. For further information, please refer to next instruction further in the manual.
	Press this button repeatedly to select the available audio language provided by the disc (only for DVD discs).
	Press this button repeatedly to play a picture frame by frame. Press ► button to resume the normal playback. (Note: Available for DVD, VCD, MPEG4 discs etc.)
	Press this button repeatedly to activate slow-motion playback mode in different speeds. Available are: 1/2, 1/4, 1/8, 1/16 of the normal speed. Press ► button to resume the normal playback speed. (Note: Available for DVD, VCD, MPEG4 discs etc.)
	Use this function to repeat a specific part of a disc. Press this button to mark down the starting point (A) from which the selected part will be played repeatedly; and press it again to mark down the ending point (B) where the repeated playback will be finished and it will return back to point A. If you press it again, you will cancel this function and resume the normal playback. Note: Points A and B can be selected only in the same title or track.
	Press this button repeatedly to change the repeat mode. (Note: For discs VCD2.0, this function is not available if the PBC function has been activated.)
	Press this button to zoom in / out the scene. Available are: 2x, 3x, 4x, 1/2, 1/3 a 1/4. In zoom in mode, use direction buttons to move in the zoomed in picture. (Note: Available only for DVD, VCD discs.)
	Press this button to show a scene from a different camera angle. (Note: This function is only available if a disc encodes with multiple camera angles.)
	Press this button to enter / exit the program menu where you can playback the disc content in your desired order. Use numeric button in the program menu to program the playback list. Then move a cursor to „START“ and press ENTER button to start program playback. During program playback, press this button to enter the program menu. Now, move cursor to „STOP“. Press ENTER to cancel the current program playback.

Tuner

Use the following buttons in tuner mode. Press SOURCE SELECT button to select tuner mode.

	Press this button to switch between Mono and Stereo reception of the broadcast signal in FM mode.
-------------------------------------------------------------------------------------	---------------------------------------------------------------------------------------------------

- AUTO**  Press this button for auto scanning of broadcasting radio channels.
- II**  During an auto scanning, press this button to stop the process.
- SEARCH+/-**  Press this button for fine tuning (increasing / decreasing) of the frequency.
- MEMORY**  After tuning a new frequency, press MEMORY button. Then, select your favourite station by inputting its number.
-  Use the numeric buttons to select a station. For example, press 0 and 2 number to select station no. 2; or press 1 and 5 numbers to select station no. 15.
- CH+/-**  Press this button to select next / previous station.

Note:

In Tuner mode, the VOLUME +/- and MUTE buttons are also active. For more information, please refer to the remote control chapter – DVD mode.

System Setting

Menu operation

1. Press **SETUP** button on the remote control in the DVD mode to display the setup menu.
2. Press **▶/◀** buttons to select the item. Submenus of the selected item will be displayed below the item.
3. Press **▲/▼** buttons to select the desired item in the submenu. Then press **ENTER** button or **▶** button to enter the submenu. Press **▲/▼** buttons to select the desired option and press **ENTER** button to confirm or press **◀** button to cancel the selection.
4. Press **▲/▼** buttons to continue to set other items in the submenus.
5. Press **◀** buttons to go back to the previous menu.
6. Press **SETUP** button again to exit the setup menu.

1 GENERAL Setup Page

1.1 TV DISPLAY

When the device is connected to a conventional TV, you can set the aspect ratio: **4:3PANSCAN** or **4:3LETTERBOX**. The 4:3 image will be displayed in full screen in its native aspect ratio.

4:3PAN SCAN: The wide-screen image will be displayed on the screen in its native aspect ratio with some parts on the left and right cut off.

4:3LETTERBOX: The wide-screen image will be displayed on the screen in its native aspect ratio with black bars on the top and bottom side.

16:9: The wide-screen image will be displayed on the screen in its native aspect ratio while 4:3 picture will be stretched horizontally to fit in the screen.

1.2 ANGLE MARK

Set this function „ON“. If the played disc contains multiple camera angle shots, the angle mark will display on the screen. Press **ANGLE** button on the remote control to display such scene.

Note: This function is available only if the inserted discs are encoded with multiple camera angle scenes.

1.3 OSD LANGUAGE

Set the language of OSD menus.

1.4 CLOSED CAPTIONS

Set this function „ON“. If the played discs are encoded with closed captions, it will be possible them to be displayed on the screen. If you set this function „OFF“, the closed captions will be hidden.

Press **SUBTITLE** button on the remote control to display / hide the closed captions.

Note: This function is available only if the inserted discs are encoded with closed caption function.

1.5 SCREEN SAVER

ON: If the image remains motionless on the screen, for example when the disc is paused, stopped etc, for several minutes, a screen saver function will activate on the screen. Press any button, except STANDBY button, to disable this function.

OFF: Disable the screen saver function.

1.6 LAST MEMORY

ON: During playback or when you pause / stop the playback, when you open the disc compartment cover or when you remove the disc, the device will remember the last playback time. When you insert the disc again and load, the device will resume playback from the place where it was stopped.

OFF: Disable the last memory function.

2 AUDIO Setup Page

2.1 ANALOGUE AUDIO SETUP

2.1.1 DOWNMIX

LT/RT: The 5.1 channel sound is mixed into left and right channel and sound is then output via front left and front right speaker respectively.

STEREO: The 5.1 channel sound is mixed into stereo signal and sound is then output via front left and front right speaker.

Note: This function is available only for Dolby AC-3 5.1 discs.

2.2 DIGITAL AUDIO SETUP

2.2.1 DIGITAL OUTPUT

SPDIF/OFF: Digital output sound mode is disabled (coaxial cable is not connected).

SPDIF/RAW: Digital output sound will be produced in its raw format. Normally, this mode is used for DTS and Dolby Digital 5.1.

SPDIF/PCM: Digital output sound will be produced in PCM format. Normally, this mode is used for CD audio discs.

2.2.2 LPCM OUTPUT

If the digital output is set to SPDIF/PCM, this function is available.

Select a sample rating for the digital output sound. These are available: 48 kHz a 96 kHz.

Note: Some amplifiers do not support 96 kHz sampling which can affect the coaxial output.

2.3 HDCD

HDCD is a patented encode / decode process for delivering the full richness and detailed sound from HDCD-encoded CDs. You can select from digital filters 2x, 1x or OFF.

3 DOLBY DIGITAL Setup

3.1 DUAL MONO

STEREO: The device delivers sound to the left and right channels via front left and front right speakers respectively.

L-MONO: The device delivers the sound of the left channel via both front speakers.

P-MONO: The device delivers the sound of the right channel via both front speakers.

MIX-MONO: The device delivers the sound of average left and right signal via front left and front right speakers.

Note: This function is available only for Dolby AC-3 2CH discs.

3.2 DYNAMIC

When you watch movies with large dynamic scope in low set volume, for example at night, you can adjust the dynamic value up to avoid losing sound details resulting from the low set volume.

4 VIDEO Setup Page

4.1 VIDEO OUTPUT

OFF: Set video output to the CVBS.

RGB: Set the video output to red/green/blue format if the SCART output is used.

Note: If you prefer composite video output, make only the composite video connection. Composite video output is always available whichever option you select as a setting entry.

If the video setting differs from the actual video connection (except composite video connection), the picture may not always appear on the screen or it will be very poor. In such case, it is necessary to cancel all actual settings and select appropriate settings or press V-MODE button on the remote control until the picture becomes normal.

4.2 COLOUR SETTING

4.2.1 SHARPNESS

You can select from: HIGH, MEDIUM or LOW.

4.2.2 BRIGHTNESS, CONTRAST, HUE and SATURATION

Press ◀▶ buttons to select the desired item and adjust its value. Then press ENTER button to confirm.

4.2.3 GAMMA

You can select from: HIGH, MEDIUM or LOW.

5 PREFERENCE Setup Page

If there is no disc or the CD compartment cover is opened, or the playback is stopped, this function is available.

5.1 TV TYPE

This device supports two types of TV broadcasting standards NTSC and PAL.

PAL: If the connected TV is in PAL format which is used for Europe, select this mode. Video signal of a NTSC format will be transformed on the output to PAL format.

AUTO: If the connected TV provides multiple formats, select AUTO mode. The video signal output format will be accommodated to video signal of the disc.

NTSC: If the connected TV is in NTSC format which is used for Taiwan, America and Canada, select this mode. The video signal of PAL format will be transformed on the output to NTSC format.

Note: If you make a wrong selection, the picture will be very poor. In such case, you should change the setting.

5.2 PBC (Play Back Control)

ON: Select „ON“ to activate the PBC function. When playing the discs encoded with PBC function, such as VCD 2.0 etc., press PBC button to go back to PBC menu.

OFF: Select „OFF“ to disable this function.

Note: This function is available only if the inserted discs such as VCD 2.0 etc., support this function. DVD, VCD 1.1, CD-DA and MP3 discs do not support this function.

5.3 AUDIO, SUBTITLE and DISC MENU

Select your preferable audio language, subtitle language and disc menu language. Press AUDIO button to enter the audio language menu and press SUBTITLE button to enter the subtitle menu.

5.4 PARENTAL LOCK

This device allows a user to set a maximum rating limit of movies which can be viewed. The movies with higher rating than the rating limit of the device cannot be viewed until you enter the correct password. What's more, it is necessary to cancel the set age limit. The default password is 136900.

Note: This function is available only if the inserted discs support the parental lock function.

5.5 PASSWORD

5.5.1 PASSWORD MODE

You can activate or disable the password function.

Note: It is necessary to enter the valid password and press ENTER button to confirm before you change this option. The default password is 136900.

5.5.2 PASSWORD

You can cancel the password in this submenu.

Note: The default password (136900) is always active even if you change it.

5.6 DEFAULT FACTORY SETTING

Use this function to reset all your settings (except password mode and parental lock) and restore the default factory setting.

CD ripping

CD ripping is a process of copyrighting from a CD/HDCD disc and saving the audio content into the compressed digital audio format.

With this function, you can copy tracks of a CD/HDCD disc to connected USB memory device.

Place a CD or a HDCD disc to the device and connect an USB memory drive to the device at the same time. Press **RIPPING** button on the remote control and the ripping menu will display on the screen. Use navigation buttons to move a cursor in the menu.

In the „**Track**“ window, there will display all the tracks and their playback time. Highlight the tracks you wish to copy and save on USB. Then press **ENTER** to confirm. Highlight the tracks once again and press **ENTER** button to cancel the selection. Highlight „**Select All**“ and press **ENTER** button to select all the tracks of the disc. If you select „**Select None**“ and you press **ENTER** button, you will cancel all the selection.

CD RIP			
OPTIONS		Track	
Speed	Normal	<input checked="" type="checkbox"/>	track01 04:38
Birate	128kbps	<input checked="" type="checkbox"/>	track02 03:34
Create ID3	Yes		track03 03:01
Device	USB		track04 03:28
			track05 04:48
			track06 03:32
			track07 04:00
			track08 03:08
SUMMARY			
Selected Track	2		
Selected Time	08:10		
Start	Exit	Select all	Select none

In the „**SUMMARY**“ window, you can check the information of the number of the selected tracks, total playing time of the selected tracks.

In the „**OPTIONS**“ window, you can select the ripping speed, ripping bitrate and set „Created ID3“ to „Yes“ to activate the ID3 information mode during the ripping process, if available. If you select „No“, the function will be disabled. Highlight these functions respectively, then press **ENTER** button.

After finishing the setting, move a cursor to „**Start**“ and press **ENTER** button to start the ripping process. If you want to cancel the process, highlight „**Exit**“ and press **ENTER** button or just press **RIPPING** button on the remote control.

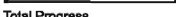

CD RIP		
Ripping	Selected	Track
Track Progress 	track01	50%
Total Progress 	track02	03:34
<input type="button" value="CANCEL"/>		
SUMMARY		
Now ripping Track	01/02	

After the ripping process begins, the system will proceed to the next menu page.

In the „**CD RIP**“ window, a track progress bar will display (Track Progress) as well as total progress of whole ripping process (Total Progress). It shows how much time of a track or of total time has elapsed and how many tracks have been copied.

During the ripping process, select **CANCEL** whenever you need to cancel the process and confirm by pressing the **ENTER** button.

Copied tracks of CD or HDCD discs will be stored in a folder created automatically by the system in the connected USB drive. If one track shares the same name as already copied track, a dialog window will appear on the screen to warn you of that. Press **ENTER** button to continue and rewrite the existing track by a new one. If you select **CANCEL**, you will leave the menu. And you can select a menu to create a new folder in the connected USB drive to save the copied tracks.

CD RIP		
Ripping	Selected	Track
Track Progress 	track01	04:38
Total Progress 	track02	03:34
SUMMARY		
The file has existed Replace it or not?		
<input type="button" value="OK"/>	<input type="button" value="CANCEL"/>	

Create a new folder

To create a new folder in the connected USB drive, open the disc compartment cover and then close it. The tracks copied afterwards will be saved in a newly created folder.

KODAK CD Picture Playback

Insert a KODAK CD to the disc compartment. The device will load the inserted CD automatically.

Press **■** button to display thumbnail mode to preview the pictures on the screen.

In this mode, use the navigation buttons to select a picture and then press **ENTER** button to start playback from the selected picture.

In this mode, use the navigation buttons and press **ENTER** button to select Slide Show, Menu, Prev or Next at the bottom of the screen

Slide Show: to start slide show playback

Menu: to enter the instruction menu of remote key functions. In the menu, press **ENTER** button to turn over to the next menu page and press it again to exit the menu.

Prev/Next: to go to the previous or next picture.

Remote key functions

■ to enter thumbnail mode to preview the pictures.

PROG to change the transition mode.

ZOOM During the playback, press **ZOOM** button and then press **▶▶/◀◀** to zoom in / out the picture. When the picture is zoomed in, use the direction buttons to move inside the picture. Press **ZOOM** button again to exit this mode.

◀◀/▶▶ to skip to previous or next picture during the playback.

▶|| to pause the playback. Press this button again to resume the playback.

◀ / ▶ to rotate the picture counterclockwise / clockwise during the playback.

▲ / ▼ to create a vertical / horizontal picture mirror.

MP3 / MPEG4 Playback

Insert a MP3 / MPEG4 disc into the device and then a respective menu will appear on the screen.

Operating

Press **▲ / ▼** buttons to select a folder or a file. Then press **ENTER** button to open the selected folder or to play the selected file. You can use the numeric buttons to select a folder or a file. In the menu, press **◀** button to return to the upper menu. Press **◀◀ / ▶▶** buttons to turn over to the previous or next page.

PROG Press this button repeatedly to change between FOLDER or FILE LIST modes.

MENU During playback of MPEG4 disc, press this button to return to the main menu.

Note: During playback, the following buttons are also available: **◀◀, ▶▶, ▶||, ■** (to pause playback), **REPEAT, A-B, VOLUME +/-, MUTE**. For more information, please see „Remote Control“ chapter.

USB Playback

Connect a USB drive to the USB slot on the device. Then press **USB** button and you can play the files stored in it. Press **USB** button to return to DVD mode.

Note:

In case the device gets damaged when the USB drive is inserted, turn off the device, disconnect the power cord from the power outlet and remove the USB drive. Then connect the power cord again to the power outlet. The device will resume the normal status.

Playback operation is the same as for MP3 / MPEG4 playback.

Trouble shooting

The below table shows the basic problems which you can meet when you operate the device. Before calling the service centre, make sure at first whether you can repair the device yourselves.

However, if the defect is not mentioned in the below table, in no cases attempt to repair the device yourselves. The device does not contain any part which a user can repair himself.

If the defect stated below remains, immediately stop using the device and call a service centre.

Defect	Cause	Solution
No power.	The power cord is not plugged properly or is not connected securely.	Check the power cord is connected properly.
Picture There is no picture or it is very poor.	The video cable is not connected properly. Video output mode of the device is not set correctly. Video input mode of your TV is not set correctly.	Connect the video cable properly. Press V-MODE button repeatedly to select the right mode. Select the appropriate video input mode.
Sound There is no sound or the sound is distorted.	The audio cable is not connected properly. The volume is set to minimum. The sound is muted. The disc is in fast forward / rewind mode.	Connect the audio cable properly. Increase the volume. Press MUTE button to resume the original volume. Press ► button.
The device does not play the inserted disc.	The disc has not been inserted correctly. The rating limit of the disc is higher than the limit of the device parental lock. The disc is not compatible with the device. The disc is dirty.	Check the inserted disc. Change the rating limit of the parental lock. - Clean the disc.
The device will turn off when inserted USB drive.	The inserted USB device is not probably certified.	The device cannot play any uncertified USB drive. In such case turn off the device, disconnect the power cord from the power outlet and remove the USB drive. Then plug it in again and the device will resume normal status automatically.
The buttons on the device do not work.	The device is being interfered with static electricity.	Turn off the device and disconnect the power cord from the power outlet. Then plug it in again and turn on again.
The remote control does not work.	There are no batteries in the remote control. The batteries are out of charge. The remote control does not point to the remote control sensor. The remote control is out of the operating area. The device is turned off.	Insert two 1,5V batteries AAA type into the remote control. Replace the batteries for new ones. Point the remote control to the sensor area. Make sure the remote control is within operating area. Turn off the device, disconnect from the power outlet. Then plug it in again and turn on again..

Technical specifications

Power supply		100 – 240 V~ 50/60 Hz
Power consumption		20 W
Power consumption in standby mode		<1 W
Operating conditions	Temperature	- 10° - + 40°C
	Humidity	5 – 90 %
Outputs	TV system	PAL / NTSC
	Frequency	20 Hz – 20 kHz
	S/N (A weight)	> 80 dB (1 kHz)
	Frequency range	≥70 dB (1 kHz)
	THD + noise	≤ - 60 dB (1 kHz)
	WOW FLUTTER	Below the limit of device measure
Tuner	FM band range	87,5 MHz – 108 MHz
Power output (max)		2 x 5 W
Frequency response		± 1,5 dB (20 Hz – 20 kHz)

INSTRUCTIONS AND INFORMATION REGARDING THE DISPOSAL OF USED PACKAGING MATERIALS

Dispose of packaging material at a public waste disposal site.

DISPOSAL OF USED ELECTRICAL AND ELECTRONIC APPLIANCES



The meaning of the symbol on the product, its accessory or packaging indicates that this product shall not be treated as household waste. Please, dispose of this product at your applicable collection point for the recycling of electrical & electronic equipment waste. Alternatively in some states of the European Union or other European states you may return your products to your local retailer when buying an equivalent new product. The correct disposal of this product will help save valuable natural resources and help in preventing the potential negative impact on the environment and human health, which could be caused as a result of improper liquidation of waste. Please ask your local authorities or the nearest waste collection centre for further details. The improper disposal of this type of waste may fall subject to national regulations for fines.

For business entities in the European Union

If you wish to dispose of an electrical or electronic device, request the necessary information from your seller or supplier.

Disposal in other countries outside the European Union

If you wish to dispose of this product, request the necessary information about the correct disposal method from local government departments or from your seller.



This product meets all the basic EU regulation requirements that relate to it.

Changes to the text, design and technical specifications may occur without prior notice and we reserve the right to make these changes.