

SENCOR®

SPV 7911M4

PORTABLE DVD PLAYER WITH 9" (23cm)
LCD SCREEN AND DVB-T TUNER

PŘENOSNÝ DVD PŘEHRÁVAČ S 9" (23cm)
LCD OBRAZOVKOU A DVB-T TUNEREM

PRENOSNÝ DVD PREHRÁVAČ SO 9" (23cm)
LCD OBRAZOVKOU A DVB-T TUNEROM

HORDOZHATÓ DVD LEJÁTSZÓ 9" (23cm)
LCD KÉPERNYÓVEL ÉS DVB-T TUNERREL

PRZENOŚNY ODTWARZACZ DVD
Z WYŚWIETLACZEM LCD 9" (23cm)
I TUNEREM DVB-T

ПОРТАТИВНЫЙ ПРОИГРЫВАТЕЛЬ
DVD-ДИСКОВ С 9-ДЮЙМОВЫМ (23cm)
ЖК ЭКРАНОМ DVB-T ТЮНЕРОМ

NEŠIOJAMAS DVD GROTVUVAS SU 9" (23cm)
LCD EKРАНU DVB-T IMTUVU



USER'S MANUAL
NÁVOD K POUŽITÍ
NÁVOD NA OBSLUHU
FELHASZNÁLÓI KÉZIKÖNYV
INSTRUKCJA OBSŁUGI
РУКОВОДСТВО ПОЛЬЗОВАТЕЛЯ
VARTOTOJO VADOVAS

EN CZ SK HU PL RU LT

Contents

Important safety conditions.....	2
Description of the device	7
Remote control	8
Connection	10
Connecting to a TV	10
Connecting to USB	11
Playback.....	12
Playback of MP3/WMA/MPEG4 files.....	12
Viewing images.....	13
System setup.....	14
Language (Language settings).....	14
Video (Video settings).....	14
Rating (Access settings).....	15
Misc (Miscellaneous settings).....	16
DVB-T reception	17
First installation.....	17
Basic DVB-T menu	17
Troubleshooting.....	24
Technical specifications	26

For the correct installation and setup of this device, please carefully read the entire user's manual before starting. Keep the read user's manual in case you need it in the future.

Important safety instructions

Important safety conditions

If you want to use this product correctly, carefully read this user's manual and store it for future reference.

General safety instructions

- Read this user's manual. Keep the user's manual in a safe place for future reference. If you give this product to a third party, hand over the user's manual together with the product.
- Follow the instructions contained in this user's manual.
- Heed all warnings.
- Adhere to all instructions.
- Use only accessories determined by the manufacturer.
- An open flame must not be placed on the product, e.g. burning candle .
- Use the product in a temperate climate zone.
- Neither the manufacturer nor the seller of the device under no condition takes responsibility for any direct or indirect damages caused by not adhering to instructions for installation, setup, use, service or cleaning of this device as described in this user's manual.
- Protect the device against being knocked, dropped, hit, shaken and against vibrations, humidity and dust.
- Before allowing children to use the device, they must be appropriately to their age, informed about the correct and safe use of the player.

Installation, operation

- Install the device according to the instructions in the user's manual.
- Leave free space on all sides of the device, necessary for proper air circulation. This removes the heat created during operation. Covering the ventilation openings of the device's case creates a risk of overheating or damaging the device. It is necessary to ensure that the ventilation openings are not blocked, e.g. by a newspaper, table cloth, curtain, etc. Follow the installation instructions in the user's manual.
- Do not install the device in direct sunlight or near sources of heat, such as heaters, heat exchangers, stoves or other appliances (including amplifiers) producing heat. High temperatures significantly reduce the lifetime of electronic components in the device. Do not use or leave the device in the vicinity of an open fire.
- The device must not be exposed to dripping or running water and objects filled with water must not be placed on it, e.g. vases. Protect the device against rain, spray or contact with any other liquid, do not leave or install the device outdoors. Do not use the device outdoors. Not adhering to these instructions creates a risk of electrical shock or fire hazard.
- Do not use this device near water.
- Do not try to circumvent the polarised power plug safety feature. If the power plug cannot be inserted into your power socket, contact a qualified electrician to replace the old type of power socket.
- Before connecting the device into a power socket, check that the voltage in your power socket corresponds to the voltage on the rating label of the device or on its power adapter.
- Make sure that the power cord is not stepped on or compressed, particularly near the power plug, power socket and at the point where it exits the device or the adapter. The power plug (adapter) is used as a disconnection device and must be easily accessible.
- Remember to always disconnect the power plug (adapter) from the power socket before disconnecting the power cable from the back side of the device.
- Disconnect the device from the power socket during storms or if you will not be using it for a longer time.

- Avoid moving the device from a cold environment to a warm one or vice versa, or when using the device in a very humid environment. Air humidity may condense on some components inside the case of the device and the device may stop working temporarily. If this occurs leave the device in a warm and well ventilated place and wait 1 – 2 hours until the moisture evaporates and the device can once more be used as usual. Take care especially during the first use of the player immediately after its purchase during a cold season.

Repairs and maintenance

- To prevent risk of injury through electric shock or the creation of a fire, do not take the device out of the case - there are no parts inside the case repairable or adjustable by the user without relevant equipment and qualifications. Should the device require adjustment or repair, contact a professional service centre.
- In the case of any unusual events occurring during the use of the device such as for example if there is a distinct smell of burning insulation or smoke comes out of the device, immediately turn off the device, disconnect the device from the power source and do not use the device until you have received the results of the inspection from the employees of the professional service centre.
- Have all repairs carried out by qualified personnel. Repair is necessary if the device has been damaged in any way, for example if the power cord is damaged, liquid was poured on the device, foreign objects have entered the device, the device has been exposed to rain or moisture, if the device is not working as usual or if it has fallen.
- Clean the device only with a dry cloth.

Remote control and batteries

- Do not expose the remote control or the batteries to direct sunlight or sources of heat, such as heaters, heat exchangers, stoves or other appliances (including amplifiers) producing heat. Do not use or leave the device in the vicinity of an open fire.
- Neither the remote control nor the batteries may be exposed to dripping or running water and objects filled with water must not be placed on them, e.g. vases. Protect against exposure to rain, spraying or pouring of any kind of liquid. Do not use outdoors. Not following these instructions creates a danger of damage to the remote control or the battery.
- Do not use this device near water.
- It is necessary pay attention to the environmental impact aspects of battery disposal.
- The incorrect use of batteries may cause the leakage of the electrolyte and corrosion. To ensure that the remote control works correctly, proceed according to the instructions below:
 - Do not insert the batteries in the wrong direction.
 - Do not charge, heat, open or short circuit the batteries.
 - Do not throw batteries into a fire.
 - Do not leave discharged batteries in the remote control.
 - Do not combine various types of batteries or new and old batteries.
 - If you will not be using the remote control for a longer period of time, remove the batteries to prevent potential damage caused by a subsequent battery leakage.
 - If the remote control is not working correctly or its operational range is reduced, change all batteries for new ones.
 - If electrolyte leaks out from the batteries, have the remote control cleaned by an authorised service centre.

Attention: To prevent a fire hazard or injury by electrical shock, do not expose this device to rain or humidity.

Attention: Batteries must not be exposed to excessive heat, for example sunlight, fire, etc.



This symbol indicates that there is dangerous voltage inside this device, which presents a risk of injury by electrical shock.



This symbol indicates important operating or repair instructions in the device's documentation.



This symbol indicates that the device has double insulation between the dangerous mains voltage and the parts accessible to the user. In the case of servicing use only identical spare parts.

Comments about USB connectors:

USB flash drives must be inserted into the device directly. To prevent data transmission failure or its interference do not use USB extension cables. Electrostatic discharges may cause the device to malfunction. In such an event the user must restart the device.

Before using a USB flash drive test its ability to communicate with the device and its data reading and writing speed.

To achieve maximum reading speed we recommend that you keep disc space defragmented. Use the FAT32 file system, a single partition, without protection. If reading and writing on the USB flash disk is not continuous, undesirable effects may occur such as partial image loss (distortions/checkering effects) or complete image loss, audio defects, and in extreme cases the operation will be stopped. Unexpected behaviour of the connected flash drive, or the presence of viruses or other damaging software may cause the functions of the device to stop working, necessitating a restart.

The USB connector is the standard type and is not able to power a USB device with a high power usage (e.g. hard disk drives HDD). Use devices with independent power supplies and power them from their own power supplies.

The device was designed to achieve maximum compatibility with flash drives. With respect to the variety of devices on the market it is not possible to guarantee compatibility with every USB device. In the event of difficulties try formatting the flash drive directly in the appliance. If problems persist, use a different flash drive.

Notes about disks

Handling discs

- Do not touch the surface of the disc where there is no label and where the recording is stored. When handling the disc, hold it by its edges, or by the edge and the centre disc opening. Do not stick labels on to the discs - to label a disc use soft tip markers specially designed for this purpose and label the label side of the disc.



- After playback return the disc into its cover, where it is protected against scratching. Do not leave discs in direct sunlight or near a heat source, do not leave discs in closed motor vehicles parked in direct sunlight. Risk of deformation of the disc.

Cleaning discs

- Fingerprints and dust affect the quality of the image while playing the recording from the disc. Before playing the disc remove them by cleaning the disc with a soft lint-free cloth. When cleaning a disc proceed from the centre of the disc directly towards the edge (not using circular motion).

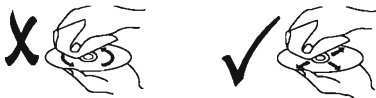

- For cleaning, do not use anti-static sprays for vinyl records, petrol, spirits or other solvents or thinners.

RW COMPATIBLE This information informs the user that the player can playback DVD-RW recordings in VR format (Video Recording).

Notes:

1. Depending on the recording media, recording method (used PC program used for the disc recording) and its finalisation, it is possible that it will not be possible to play some CD-R or DVD+/-RW/R discs.
2. Do not stick any stickers or labels on either side of the disc (the side with the printed label or the side with the recording)
3. Use the player to play only circular discs - when playing irregular shaped discs there is a risk of damaging the disc or the player.
4. Some DVD and Video CD playback operations may be intentionally programmed by the producer of the software. This device plays DVD and Video CD discs according to the disc contents created by the producer of the software and so some playback functions may not be available, or conversely there may be additional functions available.

Made under a licence from Dolby Laboratories, Inc. "Dolby", "Pro Logic" and the double D icon are registered trademarks of Dolby Laboratories, Inc.

Region code



This player is intended for playing DVD video designated by the code for region 2 or ALL (discs designated in this way can be played by all DVD players). You can find the region code of the disc on its label, the region code of the player is located on its rear or under side. After inserting a DVD with a different than the above mentioned region code into the player a message will appear on the screen "Check region Code" and the playback of the DVD will be rejected.

Supplement to the LCD TV user's manual

Measures when a static image is displayed; red/blue/green pixels on the screen

A static image can permanently damage the display part of the television

- Do not leave a static image on an LCD screen for longer than 2 hours, because this could damage the screen. This damage is known as "screen burn-in".
- Similar damage to the LCD screen can be caused by a statically located TV channel logo.
- Watching television in 4:3, 14:9 formats or similar (formats not covering the entire area of the screen) for a long time may leave marks on the right or left side, or possibly in the middle of the picture as a result of the differences in light emission. Similar damage may also occur when watching a DVD or playing games.
- The display of a static image from video games or computers for an extended period of time may cause a partial effect of a "persistent image". To prevent this effect from occurring lower the brightness and contrast when displaying a static picture.



Damage to the screen resulting from the above mentioned causes is not covered by the warranty!

Red/blue/green/black pixels may appear on the screen

- This is a characteristic feature of liquid crystal displays and does not represent a problem. LCD screens are manufactured using a very precise technology in order to achieve a very fine picture resolution. From time to time several inactive pixels may appear on the screen as a permanently red, blue, green or black pixel (up to 0.001% of the total number of pixels on the screen). This does not in any way affect the features and performance of your television.

Important notices:

This device uses a laser system. In order to learn about the correct operation of the device, please carefully read this user's manual and store it for future use.

For safety reasons the disc drive opening is located on the side of the device, thus preventing exposure to laser radiation. Under no circumstances should you in any way attempt to modify or change the disc drive opening. Do not look into the disc drive opening when inserting a disc into the disc drive or during playback. An emission of visible laser radiation could occur. Do not look into laser beams.

ATTENTION:

THIS DVD PLAYER IS A CLASS 1 LASER PRODUCT. WHEN USING THE CONTROL ELEMENTS OR CARRYING OUT SETTINGS AND PROCEDURES, WHICH ARE NOT INCLUDED IN THIS USER'S MANUAL YOU OR THOSE AROUND YOU MAY BE EXPOSED TO DANGEROUS LASER RADIATION. BECAUSE THE LASER BEAM USED IN THIS DEVICE IS DAMAGING TO HUMAN EYE SIGHT DO NOT ATTEMPT TO DISASSEMBLE THE CASE OF THE DEVICE.

LEAVE ALL REPAIRS TO A QUALIFIED SERVICE CENTRE.

ROVI

This product is equipped with copyright protection technology, which is protected by USA patents and other intellectual property laws of ROVI. Reverse engineering and disassembly are forbidden.

Description of the device

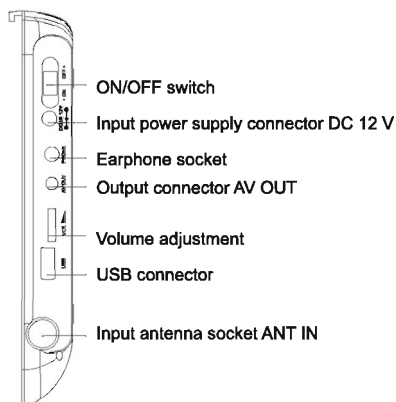
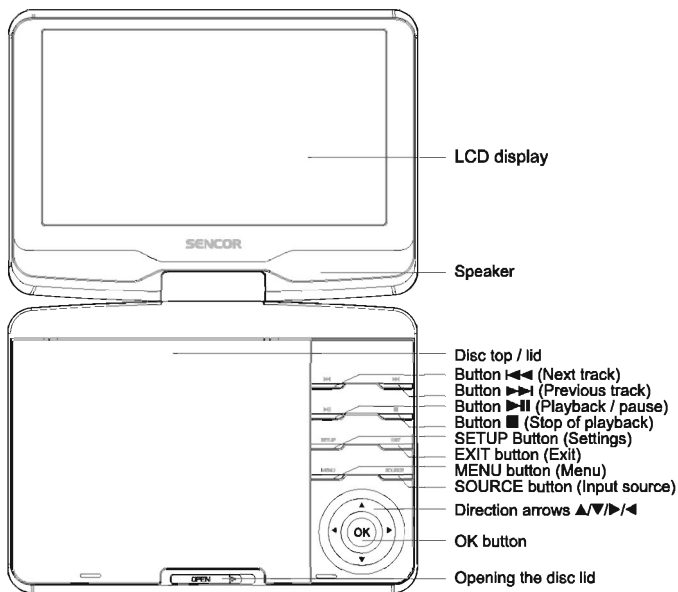

Charging indicator light



Slot for memory cards



Remote control

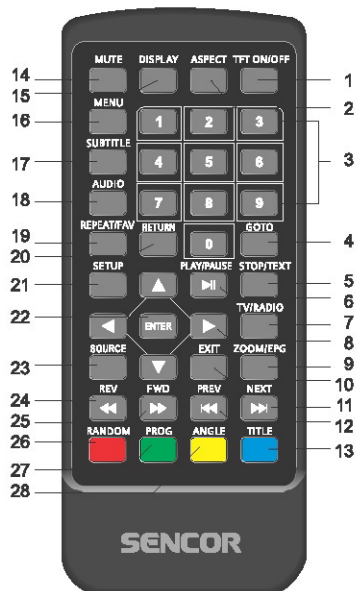

1. Main switch
2. ASPECT button
3. Numerical buttons
4. GOTO button
5. STOP button
6. PLAY/PAUSE button
7. TV / RADIO button
8. Direction arrows ▲/▼/▶/◀
9. ZOOM button
10. EXIT button
11. NEXT button
12. PREV button
13. TITLE button
14. MUTE button
15. INFO button
16. MENU button
17. SUBTITLE button
18. AUDIO button
19. REPEAT / FAV button
20. RECALL button
21. SETUP button
22. ENTER button
23. SOURCE button
24. REV button
25. FWD button
26. RANDOM / ADD button
27. PROG / DEL button
28. ANGLE button

Using the remote control

- To control the device using the remote control point the remote control at the device and then press the button with the required function. The effective range of the remote control is up to about 5 meters with a max deviation of +/- 30° from the perpendicular direction to the reception sensor of the remote control on the front side of the device. The falling capacity of the batteries gradually reduces the remote control range.
- There must be no solid obstacles in the area between the remote control and the device when the remote control is being used. During standard use the lifetime of batteries in the remote control is about 1 year.
When the effective range of the remote control is substantially reduced or when there are problems with its use, change both the batteries in the remote control.
- If you will not be using the remote control for a longer period of time, take out both batteries - in this way you will prevent potential damage caused by their leakage.

Remote control

Replacing the battery in the remote control

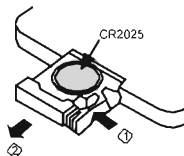

A lithium CR2025 battery is used to power the remote control.

To replace it proceed according to the follow the instructions:

1. Press the battery holder lock to the left and pull out the holder from the remote control.
2. Take the flat battery out of the holder.
3. Insert a new battery into the holder so that the + (plus) symbol on the battery faces upwards and then push the holder with the battery back into the remote control.

Note:

Remove the batteries if you will be storing the device or not using it for an extended period of time.

Handling the built-in lithium-polymer battery pack

The capacity of the built-in rechargeable lithium-polymer pack is 1,300 mAh, which equates to approx. 1.5 hours of television use. A part of the television is a management system for the built-in battery pack, which indicates a low battery charge state.

1. After the voltage in the battery pack falls below a certain value, the television will switch to a "Low power voltage" mode and an icon will start to flash on the TV screen indicating low voltage in the battery pack and the need for the user to recharge it.
2. If a power adapter is connected to the television, it will be used for powering both the television and charging the battery pack, regardless of whether the television is turned on or not.
3. If the television is not connected to the power adapter and the user continues using the television, the battery pack will go flat (indicated by a flashing icon of a flat battery pack in the top left corner of the screen) after a certain time, the screen will turn off and sound will also be turned off at the same time. After the power adapter is connected to the television, the television will switch to normal operating mode (including the playback of picture and sound).

Installation

Connecting to a TV

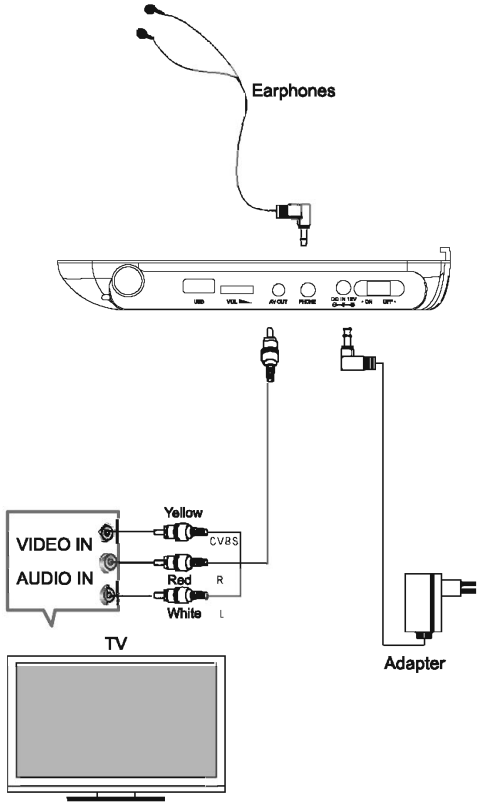

Installation

USB connection



The device is equipped with a slot for the connection of a USB flash drive for the playback of music in MP3 format or images in JPEG format, or to playback other files in formats supported by the device.

Connect the USB flash drive to the device.

Important notices:

- The device supports only flash type USB flash drives. Do not connect MP3 players or any other devices to the input USB socket, equipped with the same connector, not even by using USB cables.
- When inserting the USB flash drive ensure that the orientation of the connector is correct. Otherwise you could damage the USB flash drive and the device.

To connect a USB flash drive press the **SOURCE** button and select the **USB** mode.

All functions are the same as when playing a disc.

Playback

Playback of MP3/WMA/MPEG4 files

Disks for the playback of MP3/WMA/MPEG4 formats have the following directory structure.

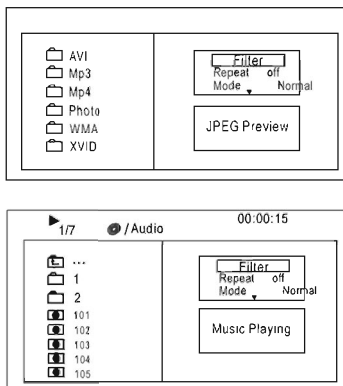

1. Using the direction arrows select the root directory and then using the **ENTER** button go into the subdirectory.
2. Using the arrow buttons select the audio file you wish to play and start playback with the **ENTER** or **PLAY** button.
3. If you wish to return to a higher level directory, use the direction arrows to select icon  and confirm with the **ENTER** button.

Filter: Enables the selection of file categories displayed in the list. You can select from 3 categories: Audio, Images, Video.

Repeat: For the selection of various modes of repeat playback

Playback

- Mode:** For the selection of the playback mode
- Normal:** For playing files on the disc in the order in which they are stored on the disc.
- Shuffle:** For playing files in the current directory in random order. If playback is not ended, after playing all the files in the directory, playback will continue in the directory playing the files in a different randomly selected order.
- Music Intro:** For playing the first 10 seconds of every file.
- Edit Mode:** For programming the playback of files from the disc in an order selected by the user. To select the directory with a file, which you wish to enter into the program, press the button ◀, select the given file and confirm with the **ENTER** button. Press **Add to program** to add to the programmed playback.
- Program view:** To display files stored in the programmed playback.
- Browser view:** To display files in a directory.
- Add to program:** Select a given file and press **Add to program** to add the file to the playback directory.
- Clear Program:** Press the STOP button (during playback it is necessary to press the button twice) and then to clear the program selection by selecting **Clear Program**.

Viewing images

CD discs for the viewing images have the following directory structure.

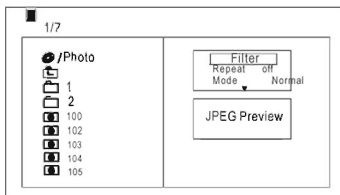

- Using the direction arrows select the root directory and then using the **ENTER** button go into the subdirectory.
- Using the arrow buttons select the image you wish to view and display it using the **ENTER** or **PLAY** button.
- If you wish to return to a higher level directory, use the direction arrows to select icon  and confirm with the **ENTER** button.

Rotating an image

In the image display mode rotate the image using the arrow buttons. Use the **ANGLE** button to change the viewing angle of the image.

System settings

Controlling the menu

Press the **SETUP** button on the remote control to enter the main menu. Using buttons **▲/▼** select the respective menu item and enter the selected item by pressing the **ENTER** button.

Use the **◀** button to return to a higher menu level.

Exit the menu using the **SETUP** button.

Language (Language settings)

In the main menu select the item **Language (Language settings)** to display the submenu.

Language	OSD Language Subtitle
Video	MPEG4 Subtitle
Audio	Audio
Rating	DVD Menu
Misc	

OSD Language (OSD language)

Select the OSD language.

Subtitle (Subtitles)

Select the subtitle language. Adhere to instructions in the DVT-T settings section.

MPEG 4 Subtitle (MP4 subtitles)

Select MP4 subtitles.

Audio (Audio)

Select the built-in dubbing language, if available.

Adhere to instructions in the DVT-T settings section.

DVD Menu (DVD Menu)

Select the film menu language.

Video (Video settings)

In the main menu select the item **Video (Video settings)** to display the submenu.

Language	Aspect Ratio
Video	TV System
Audio	Smart Picture
Rating	
Misc	

Aspect Ratio (Side aspect ratio)

The side aspect ratio of the display depends on the format of the recording on the disc. Some discs do not support your chosen aspect ratio.

System settings

If the disc is recorded in the 4:3 ratio and you wish to play it back in a wide-angle aspect ratio, then on the sides of the screen (on the left and right) there will be black bands. It is necessary to set the side aspect ratio based on the type of television that you own.

TV System (TV system)

This device supports the outputs of various systems including NTSC and PAL. If your television supports only NTSC or PAL and you select the wrong TV system, the screen will flash and the picture will disappear.

Note:

For more information about TV systems follow the instructions in your television's user's manual.

Smart picture (Intelligent picture)

You can set the display effect for output video:

- **Standard:** standard effect
- **Bright:** bright effect
- **Soft:** soft effect
- **Dynamic:** the user can set the brightness, contrast, colour, etc.

Audio (Audio setup)

In the main menu select the item **Audio (Sound)** to display the submenus.

Language	Night Mode
Video	Smart Sound
Audio	
Rating	
Misc	

Night Mode (Night mode)

Set the night mode.

Smart Mode (Intelligent mode)

Set the intelligent mode.

Rating (Access settings)

In the main menu select the item **Rating (Access)** to display the submenu.

Language	Parental Control
Video	Set Password
Audio	
Rating	
Misc	

Note:

Disc evaluation support depends on the disc.

System settings

Parental Control (Parental control)

Disc evaluation enables the user to set a level of parental control over the player. Select the item "Parental control" and then using the **ENTER** button you can change the mode.

Note:

Turn off the parental lock function before setting the level of parental control.

Set Password (Set password)

Using the number buttons 0-9 enter a 4-digit password and confirm with the **ENTER** button.

Note:

If you forget the password you can use the factory default password "**6666**".

Misc (Miscellaneous settings)

In the main menu select the item **Misc** (Miscellaneous) to display the submenu.

Language	Use Default Settings
Video	
Audio	
Rating	
Misc	

Use Default Setting (Default settings)

Use this function to return the factory settings of the device. If you use this function then all the settings you have made will be deleted.

DVB-T reception

First installation

After correctly connecting the device first turn on the television and then also the receiver. For DVB-T reception press the **SOURCE** button and select the DVB-T mode. If you have turned on the receiver for the first time or you have reset to the factory settings then the following screen will appear.



1. Select **OSD Language** (OSD Language) and using the buttons ►/◄ select a language.
2. Select **Country** (Country) and using buttons ►/◄ select a country.
3. Select **Channel Search** (Channel search) and using buttons ► or **OK** start the automatic channel search.
4. After the search has finished you will be able to watch the television.

Controlling the menu

Program Manage Setting (Program management)

Press the **MENU** button to enter the menu and select **Program**. In the menu you can set the program management. Make a selection and press the **OK** button or the ► button. Press the **EXIT** button to exit the menu.



Program Edit (Editing of programs)

Using this menu you can edit the selected channel (parental lock, skip, list of favourites, move or delete). To make changes in this menu you will be requested to enter a password. The factory set password is "888888".

DVB-T reception



Set Favourite Program (Add to the list of favourites)

You can create a list of your favourite channels making it easy to access them. To add a TV channel / radio station to one of the lists of favourites proceed as follows:

1. Select a channel, which you wish to add to the list and then press the **FAVOURITE** button. A heart symbol will appear next to the given channel and it will be included in this list of favourites.
2. To add another program proceed according to the previous step.
3. To confirm the selection and to exit the menu press the **EXIT** button.
To remove a channel from the list of favourites select in the menu in step 1: Forbid (inclusion in the favourites).

View Favourite Program (View Favourite Program)

1. Press the **FAVOURITE** button and the list of favourites will appear.
2. Press the buttons **▲/▼** to select a favourite channel.
3. Use the **OK** button to display the favourite channel on the screen.

Delete a TV or Radio Program (Delete a TV channel or radio program)

1. Select the channel you wish to delete and then press the **BLUE** button. A dialogue box will appear. Press the **OK** button to delete the channel.
2. If you wish to delete another channel or station, proceed according to the above mentioned step.

Skip TV or Radio Program (Skip a TV channel or radio station)

1. Select the channel you wish to skip and press the **GREEN** button. The skip symbol will appear. The channel will be marked "to be skipped".
2. If you wish to skip another channel or station, proceed according to the above mentioned step.
3. To confirm and exit the menu press the **EXIT** button. To remove the skip symbol, select the channel marked with the symbol and press the **GREEN** button.

Move a TV or Radio Program (Move a TV channel or radio program)

1. Select the channel you wish to move and then press the **RED** button. The move symbol will appear.
2. Using buttons **▲/▼** move the channel.
3. Press the **OK** button to confirm.
4. To move other programs proceed according to the above mentioned steps.

DVB-T reception

Lock Program (Parental lock program)

With the help of this function you will be able to lock a selected channel thus preventing children and adolescents from accessing and viewing inappropriate content.

1. Select the channel you wish to lock and press the **YELLOW** button. The lock symbol will appear. The channel will now be marked as locked.
2. If you wish to lock another channel, proceed according to the above mentioned steps.
3. To confirm and exit the menu press the **EXIT** button.
4. If you wish to remove the lock, select the locked channel and press the **YELLOW** button.
5. If you wish to watch a locked channel, you will be requested to enter a valid password. The default password is "888888".

EPG (Electronic Program Guide)

EPG is an electronic guide displayed on the screen, which displays planned programs for tuned channels 7 days in advance.



Press the **EPG** button on the remote control to enter the guide. A screen will appear containing the name of the current selected channel (can be changed using the arrows **▶/◀**), the date and time, a list of programs for the selected channel with one program highlighted (can be changed using the arrows **▲/▼**) and an extended description (Extended Description) of the highlighted program. If the description contains more than one page of information, press the **BLUE** button to display the following pages, press the **YELLOW** button to display the previous pages.

Note:

The device displays EPG information as it receives it from the transmission. The transmission of all information from a given multiplex (set of several programs on a given channel) may take up to several minutes.

The broadcaster of the given program is responsible for the content, accuracy and up-to-date status of the information on the EPG system. Time information (current time and summer time) and its accuracy is provided for by the operator of the given multiplex.

Sort (Sorting)

Using the following function you will be able to sort programs as follows:

1. **LCN** – according to the logical channel number system from the broadcast
2. **ONID** – according to the order in which the channels were turned
3. **Name of service** – according to the name of the channel
4. **ID service** – according to the station

DVB-T reception

LCN (Logical channel numbering)

Turn the logical channel number function on / off.

Video Setting (Video setup)

To enter the menu press the **MENU** button and then select **Picture (Picture)**. In this menu you can setup the picture. Using buttons **▲/▼** select the options and using buttons **▶/◀** set the value. Press the **EXIT** button to exit the menu.



Aspect Ratio (Side aspect ratio)

It is necessary to set the correct aspect ration of the screen as follows: 16:9 PillarBox, 16:9 Pan&Scan, 4:3 PanScan, 4:3 Letter Box, 4:3 Full, 16:9 Widescreen or Auto.

TV Format (TV format)

If the picture is not displayed properly, it is necessary to change the format. It is necessary to select the format used in your country.

NTSC: for the NTSC TV system

PAL: for the PAL TV system (recommended for Europe)

Channel Search (Searching for programs)

Press the **MENU** button to display the main menu and here select **Search Channel** (Tuning channels) to set the channel search method.

Press button **▶/◀** for setup.

Press **EXIT** to exit the menu.



DVB-T reception

Auto Search (Automatic tuning)

Used to search and install all channels automatically. If you launch this function, all channels found up to this time will be overwritten.

1. Select **Auto Search** (Automatic tuning) and press button **OK** or **▶** to start the search.
2. To cancel the automatic search press the **EXIT** button.



Manual Search (Manual tuning of channels)

For searching for channels manually. With this function you can add new channels without changing the current list of channels.

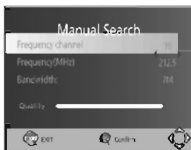

1. Select **Manual Search** (Manual search) and press the button **OK** or **▶**. The channel search menu will appear.
2. Using buttons **▶/◀** select the transmission channel. The frequency will be displayed below. Band width is selected automatically depending on the band (VHF/UHF).
3. If on the given channel there is a DVB-T digital transmission, the device will start decoding and after a while it will display its quality (Quality in the red band is insufficient, in the violet band it is temporary, in the blue band it is satisfactory). If the signal quality is sufficient, press the **OK** button to start the search. The device will search for the set of programs on this channel (digital multiplex).

As soon as a channel is found, it is stored and added to the list of channels. If it is not possible to find the channel, the system will exit the menu.

Country (Country)

Select the appropriate country.

Antenna Power (Power supply to the antenna)

Enables supplying power to the antenna if an active antenna is connected.

DVB-T reception

Time Setting (Setting the time)

Press the **MENU** button to display the main menu and here select **Time** (Time) to set the time. Using buttons **▲/▼** select an option and using buttons **▶/◀** set the value. Press the **EXIT** button to exit the menu.



Time Offset (Time offset)

Select automatic or manual setup of the time offset from GMT. Select manual setup if the operator does not supply exact time information with the broadcast (e.g. time zone or changing to summer time).

Country Region (Country region)

Select a country region if the time offset function is set to Auto.

Time Zone (Time zone)

Select a time zone if the time offset function is set to Manual.

Note:

The correct time settings together with the reception of time information from the broadcaster or operator is important both for the display of time information and for the planning of recording or viewing of programs. Pay extra attention to setting up the time.

Option (Options)

Press the **MENU** button to display the main menu and here select **Option (Options)**. This menu makes it possible to set the OSD language, subtitle language and the audio language. Make a selection and using the buttons **▶/◀** set the value. Press the **EXIT** button to exit the menu.



DVB-T reception

OSD Language (Menu language)

Select the OSD language.

Subtitle Language (Subtitle language)

Select the preferred subtitle language.

Audio Language (Audio language)

Select the preferred audio language for the TV channel. If the language is not available then the priority language will be set.

Digital Audio (Digital audio)

Select the digital audio output mode.

System Setting (Setting up the system)

Press the **MENU** button to display the main menu and here select **System** (System). This menu makes it possible to setup the system.

Using buttons **▲/▼** make a selection and using buttons **▶/◀** set the value.

Press the **EXIT** button to exit the menu.



Parental Guidance (Parental control)

You can restrict access to channels that are not suitable for children and adolescents. To lock a channel it will be necessary to enter a valid password (the default password is "888888" or a password set by you).

Set Password (Set password)

Here you can set or change the password. First enter the old password or the default password "888888". Then it is necessary to enter a new password and then to reconfirm it. After confirming press the **EXIT** button to exit the menu.

Restore Factory Default (Restore factory settings)

This function serves to renew the device's factory settings. In the main menu select Restore Factory Default (Renewal of the factory settings) and press the button **OK** or **▶** to confirm. Enter a valid password (the default password is "888888" or a password set by you). This function will renew the initial factory settings and all the performed settings will be deleted.

Information (Information)

Used to show the model, hardware or software.

Troubleshooting

In the following table you will find the most common problems that you may come across when using the player. In this way you will be able to solve some problems yourself.

Nonetheless, if the problem persists, turn off the device, stop using it and contact an authorised service centre without delay.

If you find that the device is unusually hot or smoke is being emitted, turn the device off and disconnect it from the power supply

DVD player

Problem	Possible cause	Remedy
The DVD player does not function.	The disc lid is not closed.	Close the disc lid.
	A disc is not inserted.	Insert a disc.
	The disc is inserted incorrectly.	Insert the disc correctly - label facing upwards.
	The disc is dirty or damaged.	Clean the disc or use a different disc.
	The region code of the player does not correspond to the region code of the disc.	Purchase a disc with the corresponding region code.
	Moisture in the lens.	Take out the disc and turn off the player for at least 2 hours.
No sound.	The device is incorrectly connected.	Check the connection and connect the device correctly.
	The earphones are connected (this turns off the speaker).	Disconnect the earphones.
	The DVD player sound is setup incorrectly.	Check the sound settings and correctly set the DVD player sound.
	The disc is dirty or damaged.	Clean the disc or use a different disc.
Picture is missing.	The TV screen is turned off or an incorrect video mode was selected.	Turn on the screen or set the correct video mode.
	The device is incorrectly connected.	Check the connection and connect the device correctly.
Low picture quality or sound quality.	The disc is dirty or damaged.	Clean the disc or use a different disc.
Sections are played repeatedly.	Repeated playback mode was selected.	Cancel the repeated playback mode.
	The disc is dirty or damaged.	Clean the disc or use a different disc.
Remote control is not working.	There is a barrier between the DVD player and the remote control.	Remove the barrier.
	The remote control is not pointing at the DVD player.	Point the remote control at the DVD player
	The battery was inserted incorrectly.	Take it out and insert it correctly.
	The battery is flat.	Replace the battery.

Troubleshooting

DVB-T mode

- 1. The device does not function.**
 - Turn the device off and then on again.
- 2. Remote control is not working.**
 - Check that the battery is charged.
 - Point the remote control directly at the device.
 - Remove all barriers between the device and the remote control.
- 3. Sound and picture are missing.**
 - You have connected the device incorrectly.
 - Do not use an unauthorised power supply.
 - The product is turned off.
- 4. No picture.**
 - Check the antenna settings.
 - Check that you have selected a channel and a country.
 - It is necessary perform the channel search again.
- 5. No sound.**
 - Check the volume setting.
 - Check whether the earphones are connected.
 - Check that you have not pressed the SPEAKER or MUTE button.
- 6. The picture has interference.**
 - Check that the antenna is setup correctly.
 - Weak signal, move the antenna.
- 7. No signal available**
 - Check that you have selected the country correctly.
 - Weak signal.
- 8. The picture is dark.**
 - Set the brightness and contrast correctly.
- 9. Picture or sound interference while driving.**
 - The signal at the current location is weak.

Technical specifications

Tuner	Input frequency	170 – 230 MHz 470 – 860 MHz
	Input level	-25 - -78 dBm
	Band width	7 MHz and 8 MHz
	Modulation	QPSK, 16QAM, 64QAM
Video	Decoder format	MPEG4 AVC/H.264 HP at L4 MPEG2 MP at ML.HL
Audio	Decoder format	MPEG-1 (layers 1 and 2)
Input frequency	VHF: 174 MHz – 230 MHz	UHF: 470 MHz – 862MHz
TV system	NTSC/PAL	
Supported discs	DVD, VCD, CD, MP3, CD-R, CD-RW, JPEG, DVD+ - R/W, MPEG4	
Noise level	65 dB	
Resolution	500	
Frequency response	96 kHz: 20 Hz – 20 kHz: +/- 1 IBI	
Audio noise level	90 dB	
Dynamic range	80 dB	
Distortion	< 0.5 %	
Converter	96 kHz / 24 bits	
Display	Colour TFT LCD	
Screen size	9" (23 cm)	
Video output	1 V p-p (75 Ω)	
Audio output	2CH	
Power source	12 V direct current	
Power	15 W	

Technical parameters may change without prior notice.

INSTRUCTIONS AND INFORMATION REGARDING THE DISPOSAL OF USED PACKAGING MATERIALS

Dispose of packaging material at a public waste disposal site.



DISPOSAL OF USED ELECTRICAL AND ELECTRONIC APPLIANCES

The meaning of the symbol on the product, its accessory or packaging indicates that this product shall not be treated as household waste. Please, dispose of this product at your applicable collection point for the recycling of electrical & electronic equipment waste. Alternatively in some states of the European Union or other European states you may return your products to your local retailer when buying an equivalent new product. The correct disposal of this product will help save valuable natural resources and help in preventing the potential negative impact on the environment and human health, which could be caused as a result of improper liquidation of waste. Please ask your local authorities or the nearest waste collection centre for further details. The improper disposal of this type of waste may fall subject to national regulations for fines.

For business entities in the European Union

If you wish to dispose of an electrical or electronic device, request the necessary information from your seller or supplier.

Disposal in other countries outside the European Union

If you wish to dispose of this product, request the necessary information about the correct disposal method from local government departments or from your seller.



This product meets all the basic EU regulation requirements that relate to it.

Changes to the text, design and technical specifications may occur without prior notice and we reserve the right to make these changes.

