

SENCOR®

SPV 2717

PORTABLE DVD PLAYER WITH 7" (18cm) LCD SCREEN

PŘENOSNÝ DVD PŘEHRÁVAČ S 7" (18cm) LCD OBRAZOVKOU

PRENOSNÝ DVD PREHRÁVAČ SO 7-PALCOVOU (18cm) LCD OBRAZOVKOU

HORDOZHATÓ DVD-LEJÁTSZÓ 7" (18cm) LCD KÉPERNYŐVEL

PRZENOŚNY ODTWARZACZ DVD Z EKRANEM LCD 7" (18cm) LCD

ПЕРЕНОСНОЙ DVD ПРОИГРЫВАТЕЛЬ С 7" (18cm) LCD ЭКРАНОМ

NEŠIOJAMASIS DVD GROTVAS SU 7" (18cm) LCD EKRANU

USER'S MANUAL

NÁVOD K OBSLUZE

NÁVOD NA OBSLUHU

HASZNÁLATI ÚTMUTATÓ

INSTRUKCJA OBSŁUGI

РУКОВОДСТВО ПОЛЬЗОВАТЕЛЯ

NAUDOTOJO VADOVAS

EN CZ SK HU PL RU LT

Contents

Important safety precautions	1
Notes about disks	3
Device	6
Remote control	7
Using the remote control.....	7
Replacing battery in the remote control	8
Charging the built-in lithium – polymer accumulator block	8
Connection	9
Connecting the AC adapter.....	9
Connecting the system	9
Using the device	11
Loading the disc.....	11
Function buttons	11
MP3 a JPEG discs playback.....	16
Music files	16
USB and the card reader	16
Troubleshooting	18
Troubleshooting	18
Technical specifications	19

Read the instruction carefully before installation and setup of this player. Save the manual for possible future reference.

Important safety precautions

Important safety conditions

If you want to use this product correctly, carefully read this user's manual and store it for future reference.

General safety instructions

- Read this user's manual. Keep the user's manual in a safe place for future reference. If you give this product to a third party, hand over the user's manual together with the product.
- Follow the instructions contained in this user's manual.
- Heed all warnings.
- Adhere to all instructions.
- Use only accessories determined by the manufacturer.
- An open flame must not be placed on the product, e.g. burning candle. 
- Use the product in a temperate climate zone.
- Neither the manufacturer nor the seller of the device under no condition takes responsibility for any direct or indirect damages caused by not adhering to instructions for installation, setup, use, service or cleaning of this device as described in this user's manual.
- Protect the device against being knocked, dropped, hit, shaken and against vibrations, humidity and dust.
- Before allowing children to use the device, they must be appropriately to their age, informed about the correct and safe use of the player.

Installation, operation

- Install the device according to the instructions in the user's manual.
- Leave free space on all sides of the device, necessary for proper air circulation. This removes the heat created during operation. Covering the ventilation openings of the device's case creates a risk of overheating or damaging the device. It is necessary to ensure that the ventilation openings are not blocked, e.g. by a newspaper, table cloth, curtain, etc. Follow the installation instructions in the user's manual.
- Do not install the device in direct sunlight or near sources of heat, such as heaters, heat exchangers, stoves or other appliances

(including amplifiers) producing heat. High temperatures significantly reduce the lifetime of electronic components in the device. Do not use or leave the device in the vicinity of an open fire.

- The device must not be exposed to dripping or running water and objects filled with water must not be placed on it, e.g. vases. Protect the device against rain, spray or contact with any other liquid, do not leave or install the device outdoors. Do not use the device outdoors. Not adhering to these instructions creates a risk of electrical shock or fire hazard.
- Do not use this device near water.
- Do not try to circumvent the polarised power plug safety feature. If the power plug cannot be inserted into your power socket, contact a qualified electrician to replace the old type of power socket.
- Before connecting the device into a power socket, check that the voltage in your power socket corresponds to the voltage on the rating label of the device or on its power adapter.
- Make sure that the power cord is not stepped on or compressed, particularly near the power plug, power socket and at the point where it exits the device or the adapter. The power plug (adapter) is used as a disconnection device and must be easily accessible.
- Remember to always disconnect the power plug (adapter) from the power socket before disconnecting the power cable from the back side of the device.
- Disconnect the device from the power socket during storms or if you will not be using it for a longer time.
- Avoid moving the device from a cold environment to a warm one or vice versa, or when using the device in a very humid environment. Air humidity may condense on some components inside the case of the device and the device may stop working temporarily. If this occurs leave the device in a warm and well ventilated place and wait 1 – 2 hours until the moisture evaporates and the device can once more be used as usual. Take care especially during the first use of the player immediately after its purchase during a cold season.

Important safety precautions

Repairs and maintenance

- To prevent risk of injury through electric shock or the creation of a fire, do not take the device out of the case - there are no parts inside the case repairable or adjustable by the user without relevant equipment and qualifications. Should the device require adjustment or repair, contact a professional service centre.
- In the case of any unusual events occurring during the use of the device such as for example if there is a distinct smell of burning insulation or smoke comes out of the device, immediately turn off the device, disconnect the device from the power source and do not use the device until you have received the results of the inspection from the employees of the professional service centre.
- Have all repairs carried out by qualified personnel. Repair is necessary if the device has been damaged in any way, for example if the power cord is damaged, liquid was poured on the device, foreign objects have entered the device, the device has been exposed to rain or moisture, if the device is not working as usual or if it has fallen.
- Clean the device only with a dry cloth.

Remote control and batteries

- Do not expose the remote control or the batteries to direct sunlight or sources of heat, such as heaters, heat exchangers, stoves or other appliances (including amplifiers) producing heat. Do not use or leave the device in the vicinity of an open fire.
- Neither the remote control nor the batteries may be exposed to dripping or running water and objects filled with water must not be placed on them, e.g. vases. Protect against exposure to rain, spraying or pouring of any kind of liquid. Do not use outdoors. Not following these instructions creates a danger of damage to the remote control or the battery.
- Do not use this device near water.
- It is necessary pay attention to the environmental impact aspects of battery disposal.

- The incorrect use of batteries may cause the leakage of the electrolyte and corrosion. To ensure that the remote control works correctly, proceed according to the instructions below:
 - Do not insert the batteries in the wrong direction.
 - Do not charge, heat, open or short circuit the batteries.
 - Do not throw batteries into a fire.
 - Do not leave discharged batteries in the remote control.
 - Do not combine various types of batteries or new and old batteries.
 - If you will not be using the remote control for a longer period of time, remove the batteries to prevent potential damage caused by a subsequent battery leakage.
 - If the remote control is not working correctly or its operational range is reduced, change all batteries for new ones.
 - If electrolyte leaks out from the batteries, have the remote control cleaned by an authorised service centre.

Attention: To prevent a fire hazard or injury by electrical shock, do not expose this device to rain or humidity.

Attention: Batteries must not be exposed to excessive heat, for example sunlight, fire, etc.



This symbol indicates that there is dangerous voltage inside this device, which presents a risk of injury by electrical shock.



This symbol indicates important operating or repair instructions in the device's documentation.

Important safety precautions



This symbol indicates that the device has double insulation between the dangerous mains voltage and the parts accessible to the user. In the case of servicing use only identical spare parts.

Comments about USB connectors:

USB flash drives must be inserted into the device directly. To prevent data transmission failure or its interference do not use USB extension cables. Electrostatic discharges may cause the device to malfunction. In such an event the user must restart the device.

Before using a USB flash drive test its ability to communicate with the device and its data reading and writing speed.

To achieve maximum reading speed we recommend that you keep disc space defragmented. Use the FAT32 file system, a single partition, without protection. If reading and writing on the USB flash disk is not continuous, undesirable effects may occur such as partial image loss (distortions/ checkering effects) or complete image loss, audio defects, and in extreme cases the operation will be stopped. Unexpected behaviour of the connected flash drive, or the presence of viruses or other damaging software may cause the functions of the device to stop working, necessitating a restart.

The USB connector is the standard type and is not able to power a USB device with a high power usage (e.g. hard disk drives HDD). Use devices with independent power supplies and power them from their own power supplies.

The device was designed to achieve maximum compatibility with flash drives. With respect to the variety of devices on the market it is not possible to guarantee compatibility with every USB device. In the event of difficulties try formatting the flash drive directly in the appliance. If problems persist, use a different flash drive.

Notes about disks

Handling discs

- Do not touch the surface of the disc where there is no label and where the recording is stored. When handling the disc, hold it by its edges, or by the edge and the centre disc opening. Do not stick labels on to the discs – to label a disc use soft tip markers specially designed for this purpose and label the label side of the disc.



- After playback return the disc into its cover, where it is protected against scratching. Do not leave discs in direct sunlight or near a heat source, do not leave discs in closed motor vehicles parked in direct sunlight. Risk of deformation of the disc.

Cleaning discs

- Fingerprints and dust affect the quality of the image while playing the recording from the disc. Before playing the disc remove them by cleaning the disc with a soft lint-free cloth. When cleaning a disc proceed from the centre of the disc directly towards the edge (not using circular motion).

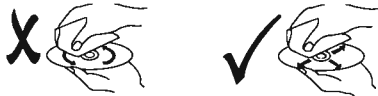

- For cleaning, do not use anti-static sprays for vinyl records, petrol, spirits or other solvents or thinners.







This information informs the user that the player can playback DVD-RW recordings in VR format (Video Recording).

Important safety precautions

Notes:

1. Depending on the recording media, recording method (used PC program used for the disc recording) and its finalisation, it is possible that it will not be possible to play some CD-R or DVD+/-RW/R discs.
2. Do not stick any stickers or labels on either side of the disc (the side with the printed label or the side with the recording)
3. Use the player to play only circular discs - when playing irregular shaped discs there is a risk of damaging the disc or the player.
4. Some DVD and Video CD playback operations may be intentionally programmed by the producer of the software. This device plays DVD and Video CD discs according to the disc contents created by the producer of the software and so some playback functions may not be available, or conversely there may be additional functions available.

Supported discs

Disc type	Logo of the disc	Contents	Size
MPEG4	MPEG4	Audio + Video	12 cm
DVD Video		Audio + Video	12 cm / 8 cm
VCD (Video CD)		Audio + Video	12 cm / 8 cm
Audio CD		Audio	12 cm / 8 cm
JPEG		Video (Pictures)	12 cm / 8 cm
Picture CD		Video (Pictures)	12 cm / 8 cm
CD-R	CD-R	Audio + Video	12 cm / 8 cm
CD-RW	CD-RW	Audio + Video	12 cm / 8 cm

Manufactured under the license of Dolby Laboratories Inc. "Dolby", "Pro Logic" and the double D icon are registered trademarks of Dolby Laboratories Inc.

Region code



This player is intended for playing DVD video designated by the code for region 2 or ALL (discs designated in this way can be played by all DVD players). You can find the region code of the disc on its label, the region code of the player is located on its rear or under side. After inserting a DVD with a different than the above mentioned region code into the player a message will appear on the screen „Check region Code“ and the playback of the DVD will be rejected.

Important notices:

This device uses a laser system. In order to learn about the correct operation of the device, please carefully read this user's manual and store it for future use.

For safety reasons the disc drive opening is located on the side of the device, thus preventing exposure to laser radiation. Under no circumstances should you in any way attempt to modify or change the disc drive opening. Do not look into the disc drive opening when inserting a disc into the disc drive or during playback. An emission of visible laser radiation could occur. Do not look into laser beams.

ATTENTION:

THIS DVD PLAYER IS A CLASS 1 LASER PRODUCT. WHEN USING THE CONTROL ELEMENTS OR CARRYING OUT SETTINGS AND PROCEDURES, WHICH ARE NOT INCLUDED IN THIS USER'S MANUAL YOU OR THOSE AROUND YOU MAY BE EXPOSED TO DANGEROUS LASER RADIATION. BECAUSE THE LASER BEAM USED IN THIS DEVICE IS DAMAGING TO HUMAN EYE SIGHT DO NOT ATTEMPT TO DISASSEMBLE THE CASE OF THE DEVICE. LEAVE ALL REPAIRS TO A QUALIFIED SERVICE CENTRE.

ROVI

This product is equipped with copyright protection technology, which is protected by USA patents and other intellectual property laws of ROVI. Reverse engineering and disassembly are forbidden.

Precautions for static images, red/blue/green/black spots on the screen

A static image may cause permanent damage to LCD panel

- Do not display a static image on the LCD panel for more than 2 hours as it can lead to image retention. This image retention is known as "screen burn". To avoid image retention, lower the brightness and contrast of the screen for viewing static images.
- Similar "screen burn" effects can be caused by displaying a static television channel logo.
- Images displayed for longer period of time in 4:3, 16:9 or similar modes, that do not spread throughout the entire screen, may leave traces of borders displayed on the left, right or center of the screen caused by the difference of light emission on the screen. A similar effect can be seen when playing a DVD or a game console.
- Displaying static images from video games and the PC for a longer period of time may produce partial after-images. In order to prevent this effect, lower the brightness and contrast of the screen for viewing static images.



The warranty does not cover damage caused by the reasons described above!

Red, blue, green and black spots may appear on the screen

- This is typical for liquid crystal panels and is not a problem. Liquid crystal panels are built with very high precision technology, ensuring fine picture detail. Dead pixels may sporadically appear on the screen depicted as red, green, blue or black spots (up to 0.001% of the total display pixels). Please note this does not affect the performance of your LCD screen.

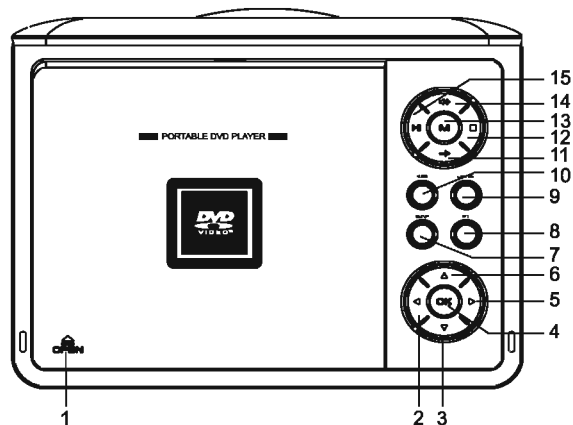

1. OPENING THE DISC DOOR
2. Button LEFT
3. Button DOWN
4. OK button
5. Button RIGHT
6. Button UP
7. SETUP button
8. TFT button
9. USB/SD button
10. AUDIO button
11. VOL- button
12. STOP/RETURN button

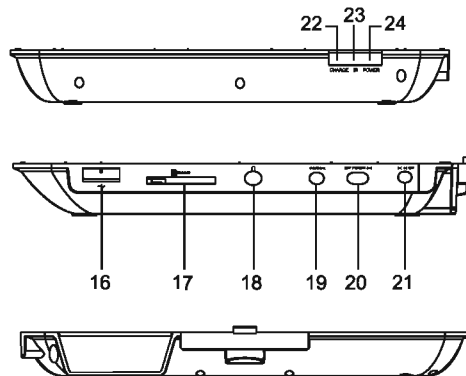

13. MENU/PBC button
14. VOL+ button
15. PLAY/PAUSE button
16. USB SLOT
17. SD/MMC SLOT
18. Earphone connection output
19. COAXIAL jack
20. POWER (ON/OFF)
21. DC IN 12V
22. LED BATTERY indicator light
23. Remote control sensor
24. LED POWER indicator light

Remote control

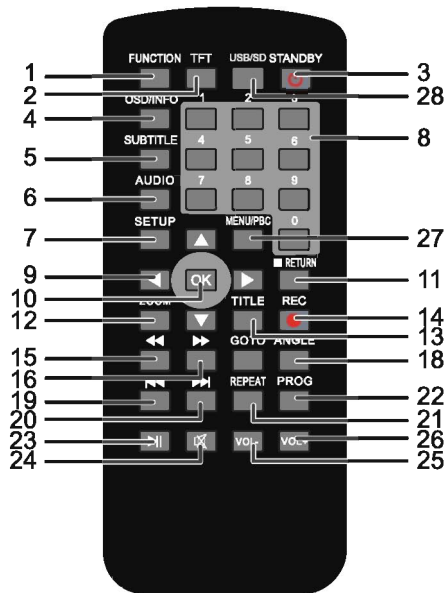

1. FUNCTION button (function selection)
2. TFT button (display)
3. STANDBY button
4. OSD / INFO button
5. SUBTITLE (subtitles) button
6. AUDIO button
7. SETUP button
8. Number pad
9. Arrows ▲/▼/◀/▶

10. OK button
11. ■ / RETURN button
12. ZOOM button
13. TITLE button
14. REC button
15. ◀◀ button
16. ▶▶ button
17. GOTO button
18. ANGLE button
19. ◀◀◀ button
20. ▶▶▶ button
21. REPEAT button
22. PROG button
23. ▶▶▶▶ button
24. MUTE button
25. VOL- button
26. VOL+ button
27. MENU/PBC button
28. USB/SD button

Using the remote control

- To use the remote control, point the remote to the TV set and then press the desired function button. The effective range of the remote control is about 5 meters with deviation +/- 30° off the perpendicular direction to the remote control sensor on the front of the device. Reduced capacity of the batteries reduces gradually the effective range of the remote control.
- Make sure that there are no obstacles in the space between the remote control and the TV set. When using normally, the life of the batteries is about 1 year. After a significant shortening of the effective remote control range or when there are problems with using the device, change both batteries in the remote control.
- If you will not use the remote control for a long time, remove both batteries from the remote control, you will prevent an eventual damage to the device by leakage.

Replacing battery in the remote control

The remote control is powered by lithium battery CR2025.

To replace the battery, follow these instructions:

1. Push the latch of the battery holder to the left and pull out the battery holder from the remote control.
2. Remove the depleted battery from the holder.
3. Insert the new battery into the holder so that the symbol + (plus) on the battery faces up and then push the holder with the battery back into the remote.

Note:

Remove the battery if you plan to store the remote control or if you will not use it for a long time.

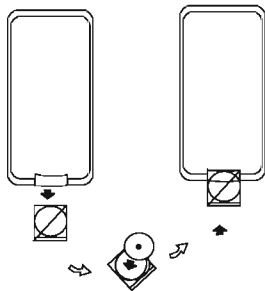

Charging the built-in lithium – polymer accumulator block

1. The capacity of the Li-ion battery is 1200 mAh. The battery can be charged using the AC adapter. Charging is indicated by red light BAT, the light turns green when fully charged.
2. The battery can be charged during the operation of the DVD player or when it is off. It lasts usually 4 hours to fully charge the battery. A fully charged battery provides 2 hours of play.
3. The battery should be fully charged at least three times to achieve full capacity.
4. If you will not use the battery for a long time, charge it once every three months in order to maintain optimum performance.
5. When a battery becomes weak, the low battery indicator will flash on the screen during play.

Note:

Protect the battery from sunlight and high temperatures and do not use it in a car. This could shorten its lifespan and capacity and may even cause a fire. The optimal operating temperature of the battery is $23^{\circ}\text{C} \pm 5^{\circ}\text{C}$, charging temperature $0^{\circ}\text{C} \sim 45^{\circ}\text{C}$, storing temperature $-20^{\circ}\text{C} \sim 60^{\circ}\text{C}$.

Connection

Connecting the AC adapter

The device can be powered by the supplied AC adapter.

1. Insert the adapter cable to the AC IN jack of the device.
2. Insert one end of the power cord in the adapter jack and the second end into the wall power outlet. You can now use the device normally.

Note:

Before disconnecting the AC adapter from the device, turn the device off to avoid damaging it.

Connecting the system

You can connect the device to a TV set, or an amplifier, or you can connect headphones.

1. **Connecting to amplifier with AC-3 or with a DTS-decoder**
 - (1) Connect the video output of the device to the video input jack (VIDEO) of the TV set.
 - (2) Connect the digital output (Coaxial) to an amplifier with a built-in AC-3/DTS decoder.
 - (3) Press SETUP button to display the setup menu of the device.
 - (4) Press ◀/▶ to select audio setup page, press ▼ to select option SPDIF.
 - (5) Press the ENTER button to select SPDIF output.
 - (6) Press ▶ or ▲ to select SPDIF/RAW or SPDIF/PCM and save the setting by pressing the ENTER button and exit menu.

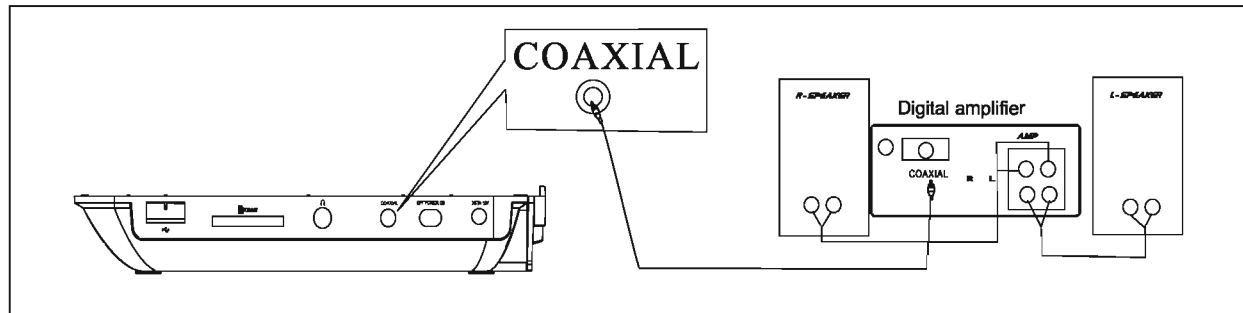

Connection

2. Connecting headphones

You can connect the headphones to the jack with the headphones symbol.

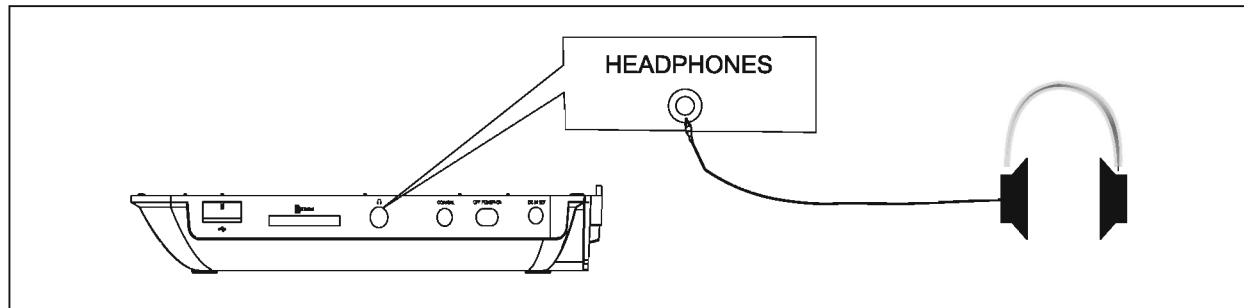

Using the device

Loading the disc

1. Press the OPEN button to open the disc's space.
2. Hold the disc by the edges and attach it to the central spindle by pushing it up.
3. Close the disc space until you hear a click.

Note:

Before you insert the disc, make sure that you are loading a clean, undamaged and unscratched disc, which is supported by the player.

Function buttons

FUNCTION button

The FUNCTION button sets brightness, contrast, hue and saturation. Increase the strength of the setting using the arrow ►, lower it using the arrow ◀.

TFT button

Turn off the screen by pressing this button, press it again to turn it back on.

USB/SD button

If you are using a USB drive or a memory card, you can toggle between the USB drive and the memory card using this button. Only SD/MMC memory cards are supported, from which you can play music, MP4 and JPEG files. USB supports USB 2.0 format.

STANDBY button

Press this button to turn the player into a standby mode, pressing it again will resume the normal mode.

OSD/INFO button

OSD (on screen menu) contains many playback functions. When you first press the OSD button during playback, the elapsed time and the remaining time of the track will appear on the screen.

SUBTITLE button

This button is functional only for the discs with subtitles in multiple languages. Press the SUBTITLE button repeatedly to select the desired language.

AUDIO / LANGUAGE button

You can select the desired language when playing a multilingual DVDs using this button.

You can choose between using the left channel, the right channel or stereo when playing multichannel CDs.

When playing a DVD with more than two languages, press the AUDIO button to select the desired language.

SETUP button

Press SETUP to display the main menu settings. When the main menu appears, press the ◀/► buttons to highlight the icon of the desired page and then press ▼/► to activate the page.

Press the ▼ button to highlight the desired option. Press ENTER or ► button to display available selections for this option. You can exit the settings menu by pressing the SETUP button.

1. GENERAL SETUP menu

This option allows you to adjust the TV display, camera angle markers, display language, closed captioning, screen saver, memory for resuming playback and the lyrics of the MP3 songs.

a) TV DISPLAY

Select the TV screen format.

OPTION	DESCRIPTION
(4:3) Normal/FS	Select in case that you will play the DVD on a TV screen with an aspect ratio 4:3. The picture from the DVD will appear whole on the screen, but it will not fill the entire screen, there will be black bars on the top and bottom of the screen.

OPTION	DESCRIPTION
(4:3) Normal/LS	Select in case that you will play the DVD on a TV screen with an aspect ratio 4:3. The picture from the DVD will fill the entire screen, but a part of the picture may be cut off (left and right margins).
(16:9) Wide	Select if you connect the DVD player to a widescreen TV set. If you do not have a widescreen TV set and select this option, the picture may appear distorted due to vertical compression.

b) Angle Mark

If there are more camera angles on the DVD you may choose between different camera angles.

OPTION	DESCRIPTION
ON	Allows selection of the camera angle by pressing the ANGLE button on the remote control.
OFF	Disables the selection of the camera ANGLE button on the remote control.

c) Language

You can select the language of the setup menu and the screen language using this option.

d) Captions

You can specify to display or hide closed captions.

OPTION	DESCRIPTION
ON	Display subtitle
OFF	Hide subtitle

e) Screen Saver

If the screen saver is on, when you DVD Player is in stop, open or no disc state for more than 2 minutes, the screen saver will be displayed. This feature can protect the screen from damage.

OPTION	DESCRIPTION
ON	Open screen saver
OFF	Close screen saver

f) Last Memory

Using this option, you can resume playback at the point where you last stopped it.

OPTION	DESCRIPTION
ON	Enabling
OFF	Disabling

g) MP3 Lyrics

With this option you can enable or disable the display of MP3 lyrics.

2. AUDIO SETUP Menu

This menu contains the speaker setting, SPDIF settings, equalizer setting and 3D processing setting.

a) Speaker Setup

This submenu contains DOWNMIX menu.

Audio mixing mode Downmix: Two modes are available: LT/RT and Stereo

LT/RT: When playing a DVD disc with 5.1 channel audio, select this option. The 5.1 channel signal will be decoded by the DVD system and played by the LT/RT channel.

Stereo: When selecting this option, the audio output will be regular stereo sound.

b) SPDIF Setup

Allows you to set the SPDIF output.

SPDIF OFF: There is no signal at the coaxial output.

Using the device

SPDIF RAW: Select, if the DVD player is connected to a power amplifier with a coaxial cable. When playing a DVD disc in a Dolby Digital or MPEG Audio format, there will be corresponding digital signals at the coaxial output jack.

SPDIF/PCM: Select, if the DVD player is connected to a dual-channel digital amplifier. When playing a DVD with Dolby Digital or MPEG audio format, the audio signals will be modulated to a two-channel PCM signal, which will be brought to coaxial output.

c) Equalizer

Allows to set the equalizer according to a popular music style.

d) 3D Processing

Setting up surround sound environment

3. DOLBY DIGITAL menu

Contains options to set channels and to compress the dynamic range.

a) LR Setup

Allows to set the output mode of the L/R signal: STEREO, LEFT MONO, RIGHT MONO and MIX MONO. Mix Mono is available only for discs with 5.1 channel audio. When set to Stereo, the output is normal stereo signal.

b) Dynamic Range Compress

Allows you to set the compress of the dynamic range of the audio, suitable for example for late night listening.

4. VIDEO SETUP menu

The menu options allow you to adjust the video output quality.

Press ENTER button to enter the submenu of functions where you can set sharpness (Sharpness), brightness (Brightness), contrast and saturation (Saturation).

5. PREFERENCE SETUP menu

This menu allows you to set up the TV system, the preferred language of the audio, subtitles and disc, parental control and to reset to default settings.

a) TV Type

Select the appropriate colour system according to your TV system type. Select NTSC for NTSC TV set, select PAL for PAL TV set and select AUTO for a TV set with an automatic system selection.

b) AUDIO

This selection allows you to choose the preferred language of the audio track.

Note: Multiple language functions depend on the disc, some discs do not support multiple language audio.

c) SUBTITLE

This selection allows you to choose the preferred language of the subtitles.

Note: Multiple language functions depend on the disc, some discs do not support multiple language subtitles.

d) DISC MENU

This selection allows you to choose the preferred language of the disc.

e) PARENTAL

Allows you to limit showing of certain movies to children on the basis of rating (on the disc label). This function does not work during password setting.

f) PASSWORD

PASSWORD ON/OFF

Password protection enabled (ON): It is necessary to enter password to change the level of parental control.

Password protection is disabled (OFF): The change of the level of parental control does not require password.

If you want to change the password, select Password Change, press ENTER and change the password.

Note: The default password is 8888.

g) DEFAULT

This selection will restore all default settings.

Note: The default password is 8888.

Using the device

Number buttons 0-9

After loading the disc, you can select individual tracks or chapters using the number pad.

Arrows ▲/▼/◀/▶

Arrows serve to navigate the various menus.

OK button

Confirmation of the selected item or start playback.

STOP/RETURN button

Press this button to stop playback, press it again to clear the memory of the stopped playback.

ZOOM button

Press ZOOM to turn on or off zoom and panning. Using ▲/▼/◀/▶ buttons you can move the magnified image. To restore the normal display, press the ZOOM button repeatedly until the normal image size appears.

MENU/PBC button

When playing DVD press MENU/PBC to return to the main menu. When playing VCD 2.0 discs, press MENU/PBC to turn on or off the direct TV function (PBC). When the PBC function is on, you can use the PREVIOUS and NEXT button or the number pad to choose items from the menu list. When the PBC function is turned off (OFF) you cannot select items from the menu list, but you can select them directly using the number pad or ◀◀ and ▶▶.

TITLE button

When playing the DVD disc, press the TITLE button to stop playback and to return to the title menu. You can use the arrow buttons and the number pad to select the desired title.

◀◀ button

Press ◀◀ button, for fast reverse. Each time you press the button this appears on the screen:

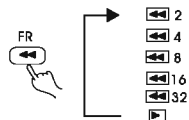

▶▶ button

Press ▶▶ button for fast forward. Each time you press the button this appears on the screen:

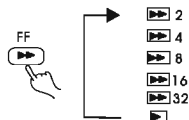

GOTO button

Using this button, you can set the starting point of the playback. Press the button and use the arrows to highlight the desired title, chapter, song or time. Confirm by pressing ENTER. The playback will start from the required point.

ANGLE button

Some discs have picture captured from multiple camera angles. You can choose between the camera angles. For example, when you are watching a moving train you can switch between the view from the front or from the left or right windows without stopping the playback.

◀◀ button

If you press ◀◀ button, the device automatically jumps to the previous chapter or track.

▶▶ button

If you press ▶▶ button, the device jumps automatically to the next chapter or track.

Using the device

REPEAT button

This button serves to repeat the title, chapter, song or disc.

PROGRAM button

You can program the order in which the items on the disc will be played. The program is active until you press this button twice ■. After the programming menu appears select the titles, chapters or songs using the number pad. You can modify your choice by pressing the CLEAR button. Select Play Program and the disc will be replayed in the programmed sequence. If you want to erase all the programmed items, select CLEAR ALL and press ENTER. The program may contain up to 20 tracks. You will exit the program mode by repeated pressing of the PROGRAM button. You can return to regular playback during the programmed playback by pressing the PROGRAM button.

▶|| Play/PAUSE button

You can pause playback by pressing this button, resume playback by pressing it again. If the playback is stopped you will resume playback by pressing this button.

MUTE button

You will disable audio from analog channels.

VOL- button

Reducing the volume of the analog input.

VOL+ button

Increasing the volume of the analog input.

REC button

Warning!

Please, remember that some audio CDs are protected by copyright and their copying is not permitted!

1. Converting music CDs

This function allows you to save music tracks from audio CDs to MP3 format. Connect USB drive to the device or a memory

card and insert the audio CD. Press the REC button to start the conversion.

Options: Press the OK button to change the parameters of the following items:

Speed	Normal – Normal speed enables you to listen to the CD during copying. Fast – Only for fast speed copying, listening is not possible.
Bit Rate	Set the bit rate for the converted MP3 files. The higher the bit rate, the higher the quality of the MP3 files. It is possible to set 96/112/128/192/256/320 kB/s and others.
Create ID3	Additional information (if available) can be saved in the form of ID3 tag.
Device	Select if the MP3 files should be saved to a USB drive or to a memory card (CARD).

a) Tracks

Shows the tracks on CD, which may be converted to MP3. Select a track using the arrows and confirm by pressing the OK button.

b) Start

Press the OK button to start the conversion.

c) Quit

To exit the conversion function, press the OK button.

d) Cancel

During the conversion select Cancel to cancel the conversion.

e) Other recording formats: Including MP3, WMA, PHOTO, AVI, MPG, DIVX. The recording method is the same.

f) Erase the contents of the USB drive or a memory card

Connect the USB device or insert the memory card, press the REC button to display the interface, which is an interface similar for the conversion of CDs to MP3. (so called ripping).

Using the device

Notes:

1. The main front panel buttons have the same functions like the remote control buttons. Here are just the functions, which are different from the remote control functions.
2. **USB/SD**
When using the USB drive and the memory card you can use this button to toggle between the USB drive and the memory card. Only SD/MMC memory cards are supported, from which you can play music, MP4 and JPEG files. USB supports the USB 2.0 format. ◀/▶ buttons have also Reverse/Forward functions.
3. ▼ button: This button has more functions, in the Setup menu functions as DOWN arrow.
5. ▲ button: This button has more functions, in the Setup menu functions as UP arrow.

MP3 a JPEG discs playback

JPEG files

JPEG uses a very effective method for image data compression and it is one of the most widely used format for storing images. Even 15 to 20 fold compression provides sufficient image quality. The format is supported by most photo editing programs, because the photographs do not require too much space and the format is easy to process. This device can read picture discs (Picture CD) with photographs in JPEG format.

1. When you insert a JPEG disc into the DVD player, the device will read the data about the disc and the screen will display the main menu. Press the MENU/PBC button to enter the picture list. Use the arrow buttons to rotate the images.
2. Press the PROGRAM button to select changing the images.

Music files

Music in the MP3 format uses compression algorithm MPEG Audio Layer 3, which compresses the audio data in up to 12:1 ratio and allows to store on one music disc up to 600 minutes of music or over 170 songs in a quality comparable to a CD.

Music disc playback

File menu for music playback. When playing a music disc you can press the PROGRAM button to select between two modes of files display: File list and folder list.

1. **FILE LIST**
Files for playback can be selected using arrows ▲ and ▼ and pressing ENTER or directly, using the number pad and pressing ENTER. If the number entered does not correspond to any track, the message CURRENT TRACK NUMBER appears on the screen.
2. **FOLDER**
After displaying the menu, select first a folder using the arrow buttons and then press the ENTER button and then choose the desired music track.

USB and the card reader

Connecting the USB/card reader

The player is equipped with a jack for USB drive connection and SD or MM memory card reader for playing music in the MP3 format or displaying pictures in the JPEG format or to play other files supported by this device.

Connect USB drive to the player/ insert SD or MM card into the player. Press USB/SD to switch on the appropriate function.

Notes:

Supported cards: SD (Secure Digital Memory), MMC (MultiMedia Card). Important notice:

- The player supports only USB memory drive type flash. Do not connect to the USB input jack an MP3 player or any other devices equipped with the same connector even using USB cable.
- When connecting take care to insert the USB drive in the correct direction. Otherwise, you could damage the USB drive and the player as well.

Using the device

Music files and MP4 files

When playing a disc (USB or card) with music files you can press the PROGRAM button to choose between two file display modes: File list and folder list.

1. FILE LIST

Files for playback can be selected using arrows ▲ and ▼ and pressing ENTER or directly, using the number pad and pressing ENTER. If the number entered does not correspond to any music track, the message „CURRENT TRACK NUMBER“ will appear on the screen.

2. FOLDER

After displaying this menu, first select the appropriate folder using the arrows and the ENTER button and then select the desired content.

JPEG files

1. Press USB/SD to switch on the appropriate function. Using the number pad, select a picture and confirm by pressing ENTER.
2. Using the arrow buttons, select a picture and press ENTER.
3. When playback is stopped: Select next picture using the number pad.
4. When playback is stopped: Select the item on the right on the first line. Press ENTER to return to the superior folder.

Troubleshooting

Troubleshooting

This troubleshooting guide will help you to find the cause and the solution to your problem.

PROBLEM	POSSIBLE CAUSE
NO POWER	Check if the power cord plug is fully inserted into the outlet.
No picture	Check the connection between the DVD player and the TV set and make sure that the TV set is working properly.
No audio	Check the connection between the DVD player and other devices and make sure that the TV set and the amplifier are working properly and are correctly adjusted.
Does not play the disc	Check if the disc was correctly inserted. Clean the disc.
The player does not respond to remote control commands	Remove any obstacles to the beam between the remote control and the DVD player. Point the remote control to the remote control sensor on the player. Check the batteries and change them if necessary.
Interference in the picture	Check if the disc is not dusty or scratched. Clean or change the disc.

If the problem persists, switch the player off, disconnect it from power and contact an authorized service center.

Technical specifications

Item	Description	
Power	DC 12 V / 1 A	
Power input	<10 W	
Laser	Semiconductor laser, wavelength 650 nm / 780 nm	
Video system	NTSC/PAL/AUTO	
Frequency	20 Hz ~ 20 kHz	
Signal/noise ratio (Audio)	≥85 dB	
THD+noise (Audio)	≤70 dB (1 kHz)	
Channel separation	≥80 dB (1 kHz)	
Dynamic range	≥80 dB	
Output level	Analog audio output	2 V ± 10 % (Impedance 10 kOhm)
	Digital audio output	1.6 Vp-p ± 20 %
	Video output	1.0 Vp-p ± 20 % (75 Ohm non symmetrical) negative sync
Operating temperature	5~35°C	
Dimensions (W × D × H)	210 × 162 × 40 mm	
Weight (approx.)	750 g	

Due to steady innovation, the data may change without prior notice. We reserve the right to change the data.

Instructions for the correct disposal of the product

INSTRUCTIONS AND INFORMATION REGARDING THE DISPOSAL OF USED PACKAGING MATERIALS

Dispose of packaging material at a public waste disposal site.

DISPOSAL OF USED ELECTRICAL AND ELECTRONIC APPLIANCES



The meaning of the symbol on the product, its accessory or packaging indicates that this product shall not be treated as household waste. Please, dispose of this product at your applicable collection point for the recycling of electrical & electronic equipment waste. Alternatively in some states of the European Union or other European states you may return your products to your local retailer when buying an equivalent new product.

The correct disposal of this product will help save valuable natural resources and help in preventing the potential negative impact on the environment and human health, which could be caused as a result of improper liquidation of waste. Please ask your local authorities or the nearest waste collection centre for further details. The improper disposal of this type of waste may fall subject to national regulations for fines.

For business entities in the European Union

If you wish to dispose of an electrical or electronic device, request the necessary information from your seller or supplier.

Disposal in other countries outside the European Union

If you wish to dispose of this product, request the necessary information about the correct disposal method from local government departments or from your seller.



This appliance complies with EU rules and regulations regarding electromagnetic and electrical safety.

Changes to the text, design and technical specifications may occur without prior notice and we reserve the right to make these changes.