

SENCOR®

STT016

**TURNTABLE
GRAMOFON
GRAMOFÓN
LEMEZJÁTSZÓ
GRAMOFON
ПРОИГРЫВАТЕЛЬ
PLOKŠTELIŲ GROTVAS**

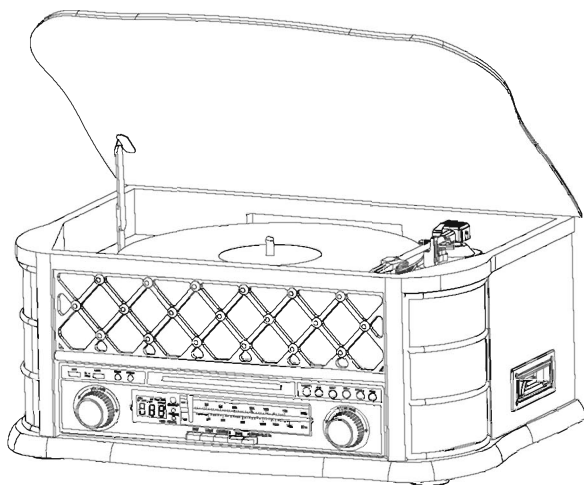

**INSTRUCTION MANUAL
NÁVOD K OBSLUZE
NÁVOD NA OBSLUHU
HASZNÁLATI ÚTMUTATÓ
INSTRUKCJA OBSŁUGI
РУКОВОДСТВО ПО ЭКСПЛУАТАЦИИ
VARTOTOJO VADOVAS**

EN CZ SK HU PL RU LT

CONTENTS

Safety precautions	2
1. Preparing the device for use	4
2. Device	5
3. Remote control	6
4. Operating instructions	7
4.1 Using the USB device for recording	8
4.2 Radio reception	8
4.3 CD playback.....	9
4.4 Playing the cassette tape	9
4.5 Using the record player.....	9
4.6 Playback after connecting to AUX IN jack.....	10
5. Care and maintenance	10
Technical data	11

SAFETY PRECAUTIONS

	<p>WARNING</p> <p>DO NOT EXPOSE THE UNIT TO RAIN OR MOISTURE TO PREVENT A RISK OF FIRE OR AN ELECTRIC SHOCK.</p>		<p>CAUTION: TO PREVENT FIRE OR ELECTRIC SHOCK, DO NOT REMOVE THE DEVICE COVER (OR ITS BACK PART). THERE ARE NO SERVICEABLE PARTS THAT USER CAN REPAIR. REFER SERVICING TO QUALIFIED SERVICE PERSONNEL.</p>
--	---	---	---

	<p>The lightning flash within an equilateral triangle is intended to alert the user to the presence of uninsulated „dangerous voltage“ within the unit’s cabinet that may cause a risk of electric shock to persons.</p>
--	--

	<p>The exclamation mark within an equilateral triangle is intended to alert the user to presence of important operating and maintenance instructions in the instruction manual.</p>
--	---

CAUTION: To operate the device correctly, read the instruction manual carefully and store in a safe place for future reference. If the device needs servicing or maintenance, contact qualified personnel only.

CAUTION: In case of removing the cover, unplug the power cord from the power outlet at first.

1. Read the instruction manual

Read all instruction manual carefully after unpacking the device. Follow all operating and other instructions in the manual.

2. Power sources

This product should be operated only from the type of power source indicated on the making label. If you are not sure of the type of power supply to your home, consult your product dealer or local power company. For products intended to operate from battery power or other sources, refer to the operating instructions.

3. Ventilation

Slots and openings in the cabinet are provided for ventilation. It protects it from overheating and ensures reliable operation of the product.

Do not block or cover these ventilation openings. The openings should never be blocked by placing the product on a bed, sofa, rug or other similar surface. This product should not be placed in a built-in installation such as a bookcase or rack unless proper ventilation is provided or manufacturer’s instructions have been adhered to.

4. High temperatures

Do not place the device near the heating elements, stoves, fire place or other sources of heat (including amplifiers). Do not place any open flame (e.g. burning candle) on the device.

5. Water and moisture

Do not use this product near water for example near a bathtub, kitchen sink, in a wet basement, near a swimming pool and the like. Do not place any objects (e.g. vases) filled with water on the device.

6. Cleaning

Unplug this product from the wall outlet before cleaning. Do not use liquid cleaners or aerosol cleaners. Use a damp cloth for cleaning.

7. Power cord protection

Power supply cords should be routed so that they are not likely to be walked on or pinched by items placed upon or against them, paying particular attention to cords at plugs, convenience receptacles, and the point where they exit from the product.

8. Overloading

Do not overload wall outlets, extension cords, or integral convenience receptacles, as this can result in a risk of fire or electric shock.

9. Lightning

For added protection for this product during a lightning storm, or when it is left unattended and unused for long periods of time, unplug it from the wall outlet and disconnect the antenna or cable system. This will prevent from damage to the product due to lightning and power lines surges.

10. Object and liquid entry

Never push objects of any kind into this product through openings as they may touch dangerous voltage points or short-out parts that could result in a fire or electric shock. Never spill liquid of any kind on the product.

11. Plug-in

Do not use the types of connection that are not recommended by the manufacturer. Otherwise you risk a healthy or possession danger. The socket you plug the power cord to or the AC adapter, must be easily accessible.

12. Accessories

Do not place this product on an unstable cart, stand, tripod, bracket, or table. The product may fall, causing serious injury to a child or adult and serious damage to the product. Use only with a cart, stand, tripod, bracket, or table recommended by the manufacturer, or sold with the product. Any mounting of the product should follow the manufacturer's instructions, and should use a mounting accessory recommended by the manufacturer. A product and cart combination should be moved with care. Quick stop, excessive force, and uneven surface may cause the product and cart combination to overturn.

13. Loading

Do not step or place any heavy objects on the device. If such heavy object falls, it may cause an injury or damage the device.

14. Connection

If you connect the device to another device, turn off and unplug all devices. Before connecting always read carefully the connection guide and follow the instructions.

15. Volume

Before turning on, always set the volume to minimum. In case of high volume you can damage your hearing or speakers.

16. Sound distortion

Do not leave the device to produce distorted sound for a long time. It can heat the speakers up and may cause a fire.

17. Earphones

Set reasonable volume level when using the earphones. The long-term listening at excessive volume can damage hearing.

18. Records

Do not use cracked, deformed or repaired records. They can break down or cause serious injury or damage the device.

19. Damage requiring service

Unplug this product from the wall outlet and refer servicing to qualified personnel under the following conditions:

- a) when the power-supply cord or plug is damaged;
- b) if liquid has been spilled or objects have fallen into the product;
- c) if the product has been exposed to rain or water;
- d) if the product does not operate normally by following the operating instructions. Adjust only those controls that are covered by the operating instructions as an improper adjustment of other controls may result in damage and will often require extensive work by qualified technician to restore the product to its normal operation;
- e) if the product has been dropped or damaged in any way;
- f) when the product exhibits a distinct change in performance this indicates a need for service.

20. Servicing

Do not attempt to service this product yourself. As opening or removing the cover may expose you to dangerous voltage or other hazards. Refer all servicing to qualified service personnel.

21. Replacement parts

When replacement parts are required, be sure the service technician has used replacement parts specified by the manufacturer or have the same characteristics as the original part. Unauthorized substitutions may result in fire, electric shock, or other hazards.

22. Safety check

Upon completion of any service or repairs to this product, ask the service technician to perform safety checks to determine that the product is in proper operating condition.

1. PREPARING THE DEVICE FOR USE

Unpacking and installation

- Carefully remove the device from the shipping carton and remove all the packing material from it.
- Unroll fully the power cord.
- Unroll the FM wire antenna and stretch it to full length.
- Place the device on a flat, firm surface protected against shocks and vibrations, close to a power outlet and far enough from appliances and equipment, which are potential sources of interference in radio reception.
- Insert the power cord plug into the AC jack on the rear of the cabinet.
- Lift the cover of the record player and turn the screw, which secures parts of the player against movement and damage during transport and storage, using a suitable coin or a similar tool clockwise.
- Moving in the direction of the arrow in the picture, remove the plastic cover of the needle of the tone arm.
- The tone arm of the record player requires careful handling – a possible damage to the needle of the tone arm is not covered by warranty!
- Remove the plastic tape used to secure the tone arm during transport.
- Release the locking lever of the tone arm.
- Insert the power cord plug into the power outlet.

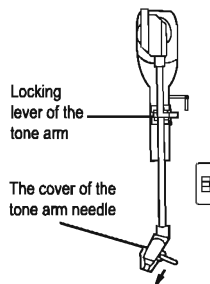
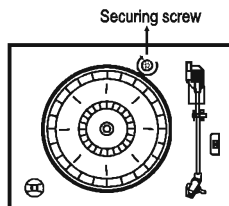

Power supply

This device is designed for AC voltage 230 V/ 50 from the power grid. Connecting this device to a different than the stated voltage may damage the unit. Such damage is not covered by the warranty.

Note:

Replacing the power cord plug in case of incompatibility with the power outlets may be performed only by authorized and qualified service person.

IMPORTANT NOTICE FOR HANDLING THE RECORD PLAYER'S COVER

When raising the cover, raise it up to the locked position of the cover holder. To close the cover, raise it first to release it and then return the cover to its original position.

TO PREVENT DAMAGE TO THE CABINET OF THE RECORD PLAYER, NEVER CLOSE THE COVER BY FORCE – IT IS NECESSARY TO RAISE AND TO RELEASE THE PLAYER'S COVER OFF THE HOLDER FIRST, BEFORE CLOSING IT.

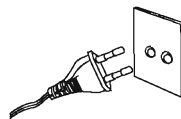

BE CAREFUL ABOUT POSSIBLE DAMAGE TO YOUR FURNITURE

This device is equipped with rubber „feet“, which prevent unwanted movement of the device when you are pushing buttons on the device. These „feet“ are made of special rubber, which does not leave hard- to- remove stains on the furniture when you place the device on a treated furniture surface. Nevertheless, in some cases, when the furniture was treated with some products based on certain oils, preservatives or some cleaning sprays, stains may appear after a prolonged contact of the rubber „feet“ of the device with the surface of the furniture. To prevent this from happening, we recommend for the protection of your furniture from possible damage that you buy and apply self-adhesive felt pads, which you fasten to the rubber „feet“ of the device before you place it on the furniture.

CARING FOR THE CABINET OF THE RECORD PLAYER

The cabinet of the device requires the same care like your furniture. To remove dust, use soft lint-free cloth, to remove fingerprints use a quality cleaning spray for surface treated furniture – be careful during the application that the spray does not come into contact with the metal or plastic parts of the cabinet. We recommend to spray a piece of cloth and clean with it the cabinet – do not spray directly onto the cabinet.

2. DEVICE

THE FRONT SIDE OF THE PLAYER

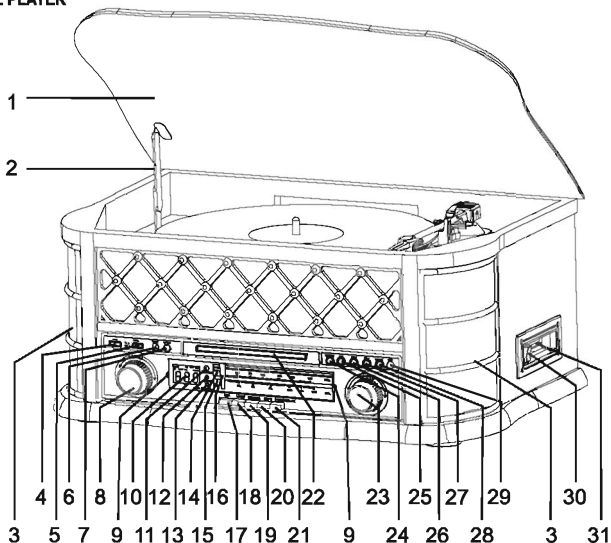

- | | |
|--|--|
| <ul style="list-style-type: none"> 1. Record player cover 2. Cover holder 3. Speakers 4. USB jack 5. POWER ON/OFF button 6. RECORD button 7. FUNCTION button 8. VOLUME control 9. Backlight of the tuning dial 10. LCD display 11. Remote control sensor 12. POWER light indicator 13. FM ST./REC light indicator 14. The FM radio tuning dial 15. The AM radio tuning dial 16. Tuning indicator | <ul style="list-style-type: none"> 17. AM button 18. FM button 19. CD/USB button 20. TAPE button 21. PHONO/AUX IN button 22. CD tray 23. Tuning control TUNING 24. PLAY/PAUSE button (▶/) 25. STOP button (■) 26. DN/R button (◀◀) 27. UP/F/F button (▶▶) 28. PLAY MODE button (↔) 29. OP/CL button (▲) (to open and close the CD tray) 30. EJ/F.F button of the cassette player (to eject the cassette / to fast forward the tape in the cassette) 31. Cassette slot |
|--|--|

REAR PANEL

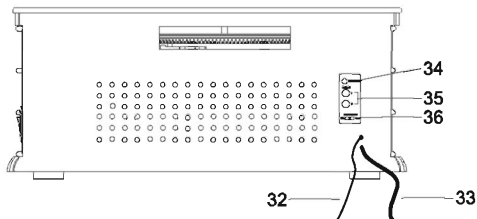

- 32. Wire FM antenna
- 33. Power cord
- 34. EARPHONE jack
- 35. AUX IN L/R jacks
- 36. RADIO REC. on/off switch ON / OFF

RECORD PLAYER

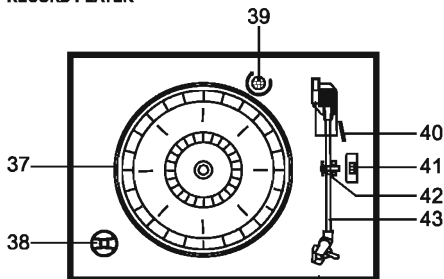

- 37. Turntable
- 38. 45 rpm adapter
- 39. Securing screw
- 40. Tone arm lever
- 41. Switch to set the turntable speed (33 / 45 / 78 rpm)
- 42. Tone arm lock
- 43. Tone arm with needle insert

3. REMOTE CONTROL

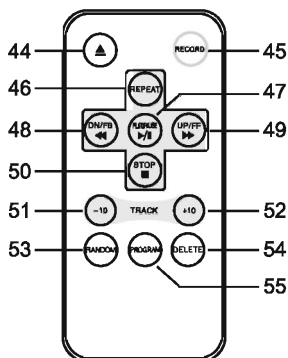

The following buttons are available to the user on the remote control:

- 44. OPEN/CLOSE
- 45. RECORD
- 46. REPEAT
- 47. PLAY/PAUSE
- 48. DN/FR
- 49. UP/FF
- 50. STOP
- 51. TRACK -10
- 52. TRACK +10
- 53. RANDOM
- 54. DELETE
- 55. PROGRAM

NOTES

- The remote control is designed to operate the CD/MP3 player and USB drive.
- The buttons on the remote control, which have the same designations as the buttons on the device, have the same functions.

Using the remote control

- To use the remote control, point the remote to the TV set and then press the desired function button. The effective range of the remote control is about 5 meters with deviation +/- 30° off the perpendicular direction to the remote control sensor on the front of the device. Reduced capacity of the batteries reduces gradually the effective range of the remote control.
- Make sure that there are no obstacles in the space between the remote control and the TV set. When using normally, the life of the batteries is about 1 year. After a significant shortening of the effective remote control range or when there are problems with using the device, change both batteries in the remote control.
- If you will not use the remote control for a long time, remove both batteries from the remote control, you will prevent an eventual damage to the device by leakage.

Replacing battery in the remote control

The remote control is powered by lithium battery CR2025.

To replace the battery, follow these instructions:

1. Push the latch of the battery holder to the left and pull out the battery holder from the remote control.
2. Remove the depleted battery from the holder.
3. Insert the new battery into the holder so that the symbol + (plus) on the battery faces up and then push the holder with the battery back into the remote.

Note:

Remove the batteries if you plan to store the remote control or if you will not use it for a long time.

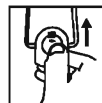
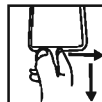

4. OPERATING INSTRUCTIONS

Turning the device on / selection of the signal source

1. To turn the device on, press POWER on the front panel of the device, the POWER indicator lights up. Use VOLUME control to adjust the volume.
2. Pressing the (AM / FM / CD/USB / TAPE / PHONO/AUX IN) button, select the desired source of the signal.
3. Switch the selected signal source to play and adjust the desired volume.
4. When you press the POWER button on the front panel of the device again, you will turn it off – the POWER light indicator will go off.

Playing the MP3 files stored on the USB drive

1. Press the CD/USB button and using the FUNCTION button switch the device to USB mode – data will appear on the display of the device --- and USB.
2. Connect the USB device to the USB jack (USB drive, MP3 player, etc.). The recording stored on the connected device will be evaluated and then the playback will start from the first track.
3. The playing of the MP3 files will be indicated by displaying the MP3 data.
4. You can use the PLAY/PAUSE, DN/F.R, UP/ F.F buttons and the STOP button during playback – their functions are identical to the CD playback functions.



Note:

To switch between using the CD player / USB playback, use the CD/USB button on the device or press the PLAY/PAUSE button on the remote control.

Playing MP3 files

- To start playback of the MP3 files from CD / USB press the PLAY/PAUSE button.
- During the MP3 file playback, following data are shown on the display: the number of the played file/ the number of the folder containing the played file / data MP3 and a symbol ▶.
- To stop playback, press the STOP button (anytime).

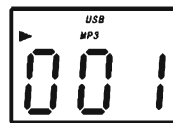

Skip to the beginning of the track / search for the required point of the CD / MP3 recording

- During the playback of CD / USB press the UP/F.F button – the player will skip to the beginning of the next track and start playing. Press repeatedly this button to skip to the beginnings of following tracks.
- Press the DN/F.R button to skip to the beginning of the currently played track, by repeated pressing of this button you will skip to the beginnings of the previous tracks.
- Press and hold the UP/F.F. button to find a desired point in the recording (search forward) or press the DN/F.R. button (search backward) (at a somewhat higher speed of the playback and a somewhat reduced volume). Release the button to continue playback from the located point.

Note:

To skip 10 tracks forward or backward, use the +10 or -10 on the remote control.

Repeat play/ random play

- Press the PLAY MODE button on the device or the button REPEAT on the remote control during playback to repeat the currently played track - message *REP* will appear on the display.
- After pressing this button again, the information  will be displayed and all the tracks from the played CD will repeat.
- After pressing this button the third time, select the required folder by pressing DN/F.R or UP/F.F button – the message *ALBUM* will appear on the display. In the same time, the names of the folder and the tracks (if they exist) will flash on the display.
- Press the PLAY MODE button on the device or the RANDOM button on the remote control again to start random playing of the selected tracks - message *RANDOM* will appear on the display. To choose next randomly selected tracks, press the UP/F.F button.
- When you press the PLAY MODE button the fifth time, the random playback will be cancelled and the disc will play in regular order.



Note

Folders are available only for discs with MP3 files – the function for repeated folder playback is not available for audio CDs playback.

Memory function for CD/MP3 playback

1. To switch the player to programming, press the PROGRAM button in the Stop mode (the inserted disc is not played) on the remote control, or the button PLAY MODE on the device. The display will show the message PROG and P01 information to select and save a track in a program for CD playback.
2. Press UP/F.F or DN/F.R button to select a track, which you want to enter into the program, confirm by pressing the PROGRAM button on the remote control or the PLAY MODE button on the device. The track will be entered into the program. Repeat this steps to enter other tracks into the program.
3. When playing a CD with MP3 files, the programming steps are identical to the above mentioned procedure.
4. To play the tracks in the programmed order, press the PLAY/PAUSE button. To play the next or the previous programmed tracks, press the UP/F.F or DN/F.R buttons. The playback will end when the last programmed track is played.
5. To stop the playback of the programmed tracks, press the STOP button, when you press it again you will delete the program.

Note

You can enter max. 20 tracks (CD audio) into the program or 99 MP3 files.

4.1 Using the USB device for recording

To record a radio show

Connect the USB drive to the USB jack, press the AM or FM buttons to switch the device to radio reception and using the TUNING control tune in the station from where you want to record the broadcast. Then press the RADIO REC ON/OFF button to switch the device to the radio recording mode and to start, press the RECORD button twice – data will start flashing on the display **USB** and **REC**, the light indicator FM.ST/REC will flash on the device. To stop recording, press the STOP button.

Notes:

The RADIO REC ON/OFF button has only one function, to switch the device into the radio broadcast recording mode. Noise may interfere with listening to the recorded radio broadcast.

Recording from audio CD

Connect the USB drive to the USB jack, press the CD/USB button and insert the CD audio into the CD tray. Press the RECORD button twice to start recording – **USB** and **REC** will flash on the display. To stop recording, press the STOP button.

Recording from CD MP3

The procedure to record from CD MP3 is the same as the one above, only instead of audio CD, insert the CD MP3 into the player.

Recording from cassette tape

Connect the USB drive to the USB jack, press the TAPE button and insert the cassette tape into the cassette slot. Press the RECORD button twice to start recording – **USB** and **REC** will flash on the display. To stop recording, press the STOP button.

Recording from the record player

Connect the USB drive to the USB jack, press the PHONE/AUX IN button and place the record on the turntable. Then move the tone arm over the desired place on the record, and when you lower it on the record, the playback will start. Press the RECORD button twice to start recording – **USB** and **REC** will flash on the display. To stop recording, press the STOP button.

Note:

Press the STOP button during the recording to end the recording.

Recording from AUX IN

Connect the USB drive to the USB jack, connect the external sources of audio signal to the AUX IN jacks on the rear panel and press PHONO/AUX IN button to switch the device to process the signals from the AUX IN jacks. Then switch the external signal source to playback and press the RECORD button twice to start recording. To stop recording, press the STOP button.

Deleting tracks from the USB drive

Connect the USB drive to the USB jack, press the CD/USB button and then press FUNCTION to switch to the USB mode. Select the file, which you want to delete on the USB drive and start playback. To delete the played file press and hold for 2 seconds the DELETE button.

Note:

You will delete one (currently played) file by pressing and holding the DELETE button.

4.2 Radio reception

1. Press the POWER button to turn the device on – the POWER indicator light will light up on the front of the device. To reduce the volume use the VOLUME control and press AM or FM to select the desired bandwidth – the tuning dial will light up after the selection.
2. Tune in the station, which you want to record using the TUNING control. If you tune in an FM radio station, which broadcasts stereo sound, the light indicator FM.ST/REC will light up. When you tune to an FM station with a lower quality stereo signal, or one which broadcasts mono, the light indicator will switch off and the device switches to mono reception.

Antennae

In the AM radio bandwidth, the device uses a built-in AM antenna. For optimum reception of the AM station, it is necessary to change direction (rotate) of the whole device.

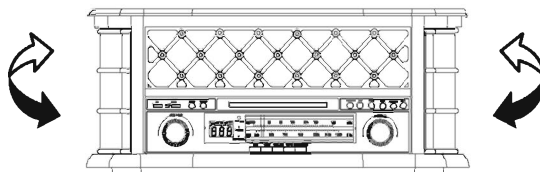

The device is equipped with a wire FM antenna for the reception of FM broadcasting, attached to the back of the player. For optimum reception of the desired station, search for suitable position of the antenna.

4.3 CD playback

1. After switching the device into the CD mode, press the CD/USB button **CD** and the --- will appear on the display. The player can play audio CDs and CD-R (RW) containing MP3 files recordings.
2. Press the OP/CL button to open the disc tray.
3. Insert the CD in the tray.
4. Press the OP/CL button to close the tray with the disc, the disc will start to turn and the disc recording will be read and evaluated immediately after closing the tray. After evaluating the disc, the playback will start, beginning with the track nr. 1 and continuing with all the following tracks on the disc. The playback will end when all the tracks on the disc are played.
5. The display will show the MP3 icon if MP3 files will be identified on the inserted disc.



4.4 Playing the cassette tape

Note:

Before inserting the cassette into the cassette slot, check the tension of the tape – a loose tape may break in the tape deck and become entangled in the mechanism of the player.

You will find the instructions how to tighten the cassette tape in the section Maintenance and Care – see below.

1. Press the POWER button to turn the device on – the POWER indicator light will light up on the front of the device. Then reduce the volume using VOLUME control.
2. To switch the device to the tapdeck, press the TAPE button.
3. Insert the cassette with recording into the cassette slot with the side you want to play facing up and the narrow longer side of the cassette – where you can see the tape (Open End) - pointing right.
4. The playback will start after you insert the tape. Adjust the volume using the VOLUME control.
5. To fast forward the cassette tape, press the E.J/F.F button halfway – after you release it, the playback will continue.
6. The playback will stop when the last recording on the tape is played – to eject the cassette from the player, press the E.J/F.F. button all the way in (possible any time). Take the ejected tape and put it in its case.
7. Press the POWER button to switch the device off – the POWER light will switch off.

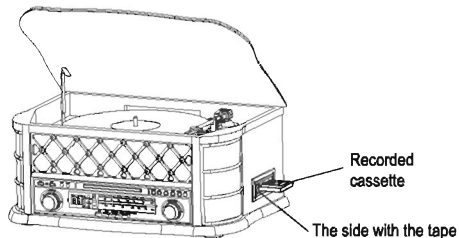

4.5 Using the record player

The device is equipped with a three speed turntable, enabling it to play records at 33, 45 or 75 rpm, the turntable is driven by a belt.

1. Press the POWER button to turn the device on – the POWER indicator light will light up. Reduce the volume.
2. To switch the device to record playing, press the PHONE button.
3. Remove the cover from the needle of the tone arm and release the lock of the tone arm, which was protecting it from damage during transport.
4. Set the speed of the turntable using the speed switch. The speed has to be identical to the speed shown on the record, which you want to play. If you set the speed to 45 rpm, insert a plastic adapter on the spindle of the turntable.
5. Place the record on the turntable.
6. Lift the tone arm using the lever from its rest position and place it over the record's grooves at the rim of the record – the turntable with the record will start turning. Release the lever and let the needle of the tone arm land on the record – the record playing will start.
7. Set the desired volume.
8. When the playing of the record will end, the tone arm will lift automatically and move into locked rest position and the turning will stop in the same time.
9. Press the POWER button to switch the device off – the POWER light will switch off.

Notes:

Do not speed up the turntable/ do not stop it by hand.

Moving the player without securing the tone arm against movement risks damaging it.

Important notes:

- To protect the record player from damage during transport and storage, the turntable of the record player is secured by a screw located at the top right area of the record player.
- **It is necessary to unblock the record player** before use by screwing the screw in entirely, using a suitable screwdriver clockwise.
- To secure the record player again (for example before another transport), loosen the screw by turning it counterclockwise.

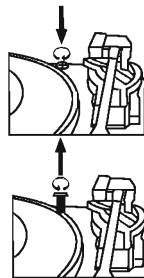

4.6 Playback after connecting to AUX IN jack

Press the PHONO/AUX IN button to switch the device to processing a signal from an external audio source connected to the AUX IN jack at the back of the cabinet.

To connect the device to AUX IN jacks, use a stereo audio cable with cinch connectors (sold separately). When using the device as instructed in the previous text, the speakers of the device will play the signal from the connected device.

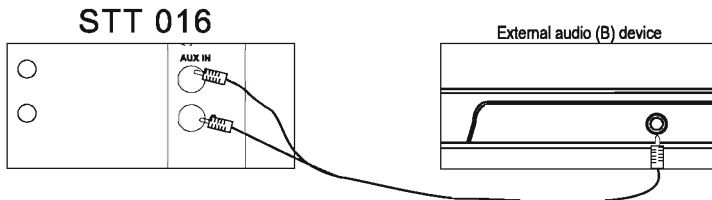

5. CARE AND MAINTENANCE

Handling the cassette tapes

The most common causes of problems with cassette tapes:

- creases on the tape causing variations in the playback speed;
- loosening of the tape causing entangling of the tape in the mechanical parts of the cassette player.

To prevent these problems, please pay attention to following instructions:

- Before you insert the cassette into the tapedeck, check through the transparent cassette case window if the winding of the cassette is uniform – see picture 1. Use a hexagonal pencil inserted into the cassette spool hole to tighten the tape.
- If the tape in the cassette is too tight, it is possible that there are creases in it, caused by loose loops of the tape visible through the transparent window of the cassette case. To correct this problem, fast forward one side of the tape in the cassette to the end.

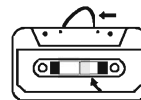

Picture 1

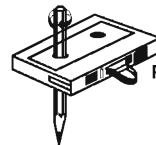

Picture 2

Use cassette tapes from well known manufacturers, do not use C-120 cassettes.

Do not expose the cassette tapes to direct sunlight, dust, oil and do not touch the tape in the cassette.

Handling CDs

- To remove the CD from its case, press the middle of the plastic insert and holding the disc by the edges, lift it up.

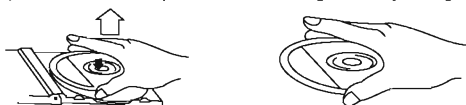

- Wipe the disc with a soft cloth to remove dust and fingerprints. The CDs do not have grooves, which might hold dust and dirt like the records, therefore by carefully wiping the disc you will remove most of the impurities. To clean a disc, proceed from the center to the edges (not in circular motion). The particles of dust and dirt not removed by cleaning of the disc will not affect the quality of the playback.



- Clean the discs regularly using lint-free cloth. Do not use solvents or abrasive cleaning products to clean discs. Use the disc cleaning kit if necessary.
- Do not write on the discs or stick labels on the discs.

TECHNICAL DATA

Radio	
Frequencies	AM: 530 – 1 600 kHz FM: 87.5 – 108 MHz
Record player	
Turntable speeds	33 / 45 or 78 rev/min.
Diameters of the records	17.5 / 25 or 30 cm
CD player	
Disc types	CD audio / CD-R (RW) MP3
USB interface	
Type of played / recorded files	MP3
Cassette tape deck	
Cassettes used	C60 – C90 (do not use C-120 cassettes)
Data common for the entire device	
Power	230 V~, 50 Hz
Power input	max. 19 W
Output	2.5 W + 2.5 W

Changes of design and technical specification are subject to change without notice.

INSTRUCTIONS FOR THE CORRECT DISPOSAL OF THE PRODUCT

Instructions and information regarding the disposal of used packaging materials

Dispose of packaging material at a public waste disposal site.

Disposal of used electrical and electronic appliances



The meaning of the symbol on the product, its accessory or packaging indicates that this product shall not be treated as household waste. Please, dispose of this product at your applicable collection point for the recycling of electrical & electronic equipment waste. Alternatively in some states of the European Union or other European states you may return your products to your local retailer when buying an equivalent new product.

The correct disposal of this product will help save valuable natural resources and help in preventing the potential negative impact on the environment and human health, which could be caused as a result of improper liquidation of waste. Please ask your local authorities or the nearest waste collection centre for further details. The improper disposal of this type of waste may fall subject to national regulations for fines.

For business entities in the European Union

If you wish to dispose of an electrical or electronic device, request the necessary information from your seller or supplier.

Disposal in other countries outside the European Union

If you wish to dispose of this product, request the necessary information about the correct disposal method from local government departments or from your seller.



This appliance complies with EU rules and regulations regarding electromagnetic and electrical safety.

Changes to the text, design and technical specifications may occur without prior notice and we reserve the right to make these changes.