

# SENCOR®

## SPV 2750

PORTABLE DVD PLAYER

PŘENOSNÝ DVD PŘEHRÁVAČ

PRENOSNÝ DVD PREHRÁVAČ

HORDOZHATÓ DVD LEJÁTSZÓ

PRZENOŚNY ODTWARZACZ DVD

ПОРТАТИВНЫЙ DVD-ПЛЕЕР

USER'S MANUAL  
NÁVOD K OBSLUZE  
NÁVOD NA OBSLUHU  
FELHASZNÁLÓI KÉZIKÖNYV  
INSTRUKCJA OBSŁUGI  
РУКОВОДСТВО ПОЛЬЗОВАТЕЛЯ

EN CZ SK HU PL RU



# Contents

<b>1. Important safety instructions</b> .....	<b>4</b>
1.1 Safety precautions .....	4
1.2 Supplement to the LCD TV user's manual .....	6
1.3 Notes on USB jack .....	7
1.4 Storage and handling discs .....	7
1.5 Accessories .....	9
<b>2. Description of device</b> .....	<b>10</b>
<b>3. Remote control</b> .....	<b>11</b>
<b>4. Basic operation</b> .....	<b>13</b>
4.1 Installation.....	13
4.2 Connecting USB device / MMC/SD/MS card.....	13
4.3 Connecting earphone .....	14
4.4 Connecting COAXIAL.....	14
4.5 Connecting to external equipment .....	14
<b>5. Playback</b> .....	<b>15</b>
5.1 Disc playback.....	15
5.2 Picture CD/JPEG playback .....	17
<b>6. Using OSD</b> .....	<b>19</b>
6.1 Checking the operational status .....	19
6.2 Selecting the camera angle .....	19
<b>7. Setup menu</b> .....	<b>20</b>
7.1 Setting the parental lock .....	20
7.2 Password change .....	21
7.3 Custom function setting .....	21
<b>8. Troubleshooting guide</b> .....	<b>23</b>
<b>9. Technical specifications</b> .....	<b>24</b>

# 1. Important safety instructions

## 1.1 Safety precautions

- If you want to use the device properly, read carefully this instruction manual and keep in a safe place for future reference. If you pass (sell) the device to another person, pass all documents, including this manual, together with the device.



The symbol of lightning flash within equilateral triangle warns there is a dangerous voltage inside the device which presents a risk of injury by electric shock.



To reduce the risk of electric shock, do not remove the cover (or back). There are no user-serviceable parts inside the device. Refer servicing to an authorised service centre.



The symbol of exclamation point within an equilateral triangle warns about operational and service instructions in the device's documentations.

### General safety instructions

- Read this instruction manual. Follow the instructions contained in this manual.
- Heed all warnings.
- Adhere to all instructions.
- Use only accessories recommended by a manufacturer.
- Do not place an open flame, e. g. burning candle, on the device.
- Use the device in a temperate climate zone.
- Neither the manufacturer nor the seller of the device, under no condition, takes responsibility for any direct or indirect damages caused by not adhering to instruction for installation, setup, use, service or cleaning of this device as described in this user's manual.
- Protect the device against being knocked, dropped, hit, and shaken and against vibrations, humidity and dust.
- Before allowing children to use the device, they must be appropriately to their age, informed about the correct and safe use of the player.
- If the device is provided by an earphone / headphone jack, do not use the earphones / headphones at high set volume. Risk of damage or lost of hearing.

### Installation, operation

- Install the device according to the instructions in the user's manual.
- Leave free space on all sides of the device, necessary for proper air circulation. This removes the heat created during operation. Covering the ventilation openings of the device's case creates a risk of overheating or damaging the device. It is necessary to ensure that the ventilation openings are not blocked, e.g. by a newspaper, table cloth, curtain, etc. Follow the installation instructions in the user's manual.
- Do not install the device in direct sunlight or near sources of heat, such as heaters, heat exchangers, stoves or other appliances (including amplifiers) producing heat. High temperatures significantly reduce the lifetime of electronic components in the device. Do not use or leave the device in the vicinity of an open fire.
- The device must not be exposed to dripping or running water and objects filled with water must not be placed on it, e.g. vases. Protect the device against rain, spray or contact with any other liquid, do not leave or install the device outdoors. Do not use the device outdoors. Not adhering to these instructions creates a risk of electrical shock or fire hazard.
- Do not use the device near water.
- Do not try to circumvent the polarized power plug safety feature. If the power plug cannot be inserted into your power socket, contact a qualified electrician to replace the old type of power socket.

- Before connecting the device into a power socket, check that the voltage in your power socket corresponds to the voltage on the rating label of the device or on its power adapter.
- Make sure that the power cord is not **STEP**ped on or compressed, particularly near the power plug, power socket and at the point where it exits the device or the adapter. The power plug (adapter) is used as a disconnection device and must be easily accessible.
- Remember to always disconnect the power plug (adapter) from the power socket before disconnecting the power cable from the back side of the device.
- Disconnect the device from the power socket during storms or if you will not be using it for a longer time.
- Avoid moving the device from a cold environment to a warm one or vice versa, or when using the device in a very humid environment. Air humidity may condense on some components inside the case of the device and the device may stop working temporarily. If this occurs leave the device in a warm and well ventilated place and wait 1 – 2 hours until the moisture evaporates and the device can once more be used as usual. Take care especially during the first use of the player immediately after its purchase during a cold season.
- To charge the storage battery integrated into the device, place the device in a well ventilated place way from combustible materials.

### Repairs and maintenance

- To prevent risk of injury through electric shock or the creation of a fire, do not take the device out of the case - there are no parts inside the case repairable or adjustable by the user without relevant equipment and qualifications. Should the device require adjustment or repair, contact a professional service centre.
- In the case of any unusual events occurring during the use of the device such as for example if there is a distinct smell of burning insulation or smoke comes out of the device, immediately turn off the device, disconnect the device from the power source and do not use the device until you have received the results of the inspection from the employees of the professional service centre.
- Have all repairs carried out by qualified personnel. Repair is necessary if the device has been damaged in any way, for example if the power cord is damaged, liquid was poured on the device, foreign objects have entered the device, the device has been exposed to rain or moisture, if the device is not working as usual or if it has fallen.
- Before cleaning, moving, removing a disc from the device or any other maintenance, unplug the device (adapter) from the power outlet first.
- Clean the device only with a dry cloth.
- Do not use petrol, thinner or other dissolvent or use abrasive cleaners, scouring pads or sponges with scourer for cleaning the device.

### Remote control and batteries

- Do not expose the remote control or the batteries to direct sunlight or sources of heat, such as heaters, heat exchangers, stoves or other appliances (including amplifiers) producing heat. Do not use or leave the device in the vicinity of an open fire.
- Do not expose sensor to strong light source (e.g. direct sunlight) or fluorescent tube light as these can decrease the efficiency and reliability of the remote control.
- Neither the remote control nor the batteries may be exposed to dripping or running water and objects filled with water must not be placed on them, e.g. vases. Protect against exposure to rain, spraying or pouring of any kind of liquid. Do not use outdoors. Not following these instructions creates a danger of damage to the remote control or the battery.
- Do not use this device near water.

- It is necessary pay attention to the environmental impact aspects of battery disposal.
- The incorrect use of batteries may cause the leakage of the electrolyte and corrosion.
- To ensure that the remote control works correctly, proceed according to the instructions below:
  - Do not insert the batteries in the wrong direction.
  - Do not charge, heat, open or short circuit the batteries.
  - Do not throw batteries into a fire.
  - Do not leave discharged batteries in the remote control.
  - Do not combine various types of batteries or new and old batteries.
  - If you will not be using the remote control for a longer period of time, remove the batteries to prevent potential damage caused by a subsequent battery leakage.
  - If the remote control is not working correctly or its operational range is reduced, change all batteries for new ones.
  - If electrolyte leaks out from the batteries, have the remote control cleaned by an authorised service centre.

**Attention:** To prevent a fire hazard or injury by electrical shock, do not expose this device to rain or humidity.

**Attention:** Batteries must not be exposed to excessive heat, for example sunlight, fire, etc.

## 1.2 Supplement to the LCD TV user's manual

### Measures when a static image is displayed; red/blue/green pixels on the screen

#### A static image can permanently damage the display part of the television

- Do not leave a static image on an LCD screen for longer than 2 hours, because this could damage the screen. This damage is known as "screen burn-in".
  - Similar damage to the LCD screen can be caused by a statically located TV channel logo.
- 
- Watching television in 4:3, 16:9 formats or similar (formats not covering the entire area of the screen) for a long time may leave marks on the right or left side, or possibly in the middle of the picture as a result of the differences in light emission. Similar damage may also occur when watching a DVD or playing games.
  - The display of a static image from video games or computers for an extended period of time may cause a partial effect of a "persistent image". To prevent this effect from occurring lower the brightness and contrast when displaying a static picture.
  - Damage to the screen resulting from the above mentioned causes is not covered by the warranty!

#### Red/blue/green/black pixels may appear on the screen

- This is a characteristic feature of liquid crystal displays and does not represent a problem. LCD screens are manufactured using a very precise technology in order to achieve a very fine picture resolution. From time to time several inactive pixels may appear on the screen as a permanently red, blue, green or black pixel (up to 0.001% of the total number of pixels on the screen). This does not in any way affect the features and performance of your television.

## 1.3 Comments about USB connectors

USB flash drives must be inserted into the device directly. To prevent data transmission failure or its interference do not use USB extension cables. Electrostatic discharges may cause the device to malfunction. In such an event the user must restart the device.

Before using a USB flash drive test its ability to communicate with the device and its data reading and writing speed.

To achieve maximum reading speed we recommend that you keep disc space defragmented. Use the FAT32 file system, a single partition, without protection. If reading and writing on the USB flash disk is not continuous, undesirable effects may occur such as partial image loss (distortions/checkering effects) or complete image loss, audio defects, and in extreme cases the operation will be stopped. Unexpected behavior of the connected flash drive or the presence of viruses or other damaging software may cause the functions of the device to stop working, necessitating a restart.

The USB connector is the standard type and is not able to power a USB device with a high power usage (e.g. hard disk drives HDD). Use devices with independent power supplies and power them from their own power supplies.

The device was designed to achieve maximum compatibility with flash drives. With respect to the variety of devices on the market it is not possible to guarantee compatibility with every USB device. In the event of difficulties try formatting the flash drive directly in the appliance. If problems persist, use a different flash drive.

Due to wide offer of SD/MMC/MS cards/USB devices on the market, we do not guarantee full compatibility of the device with all types of SD/MMC/MS cards/USB devices.

This product is equipped with copyright protection technology, which is protected by USA patents and other intellectual property laws of ROVI. Reverse engineering and disassembly are forbidden.

## 1.4 Storage and handling discs

### Handling discs

- Use discs with regular shapes. If an irregular disc (disc with a special shape) is used, the device may be damaged.
- Do not touch the surface of the disc without label as this is the record storage. When handling the disc, hold it by its edges, or by the edge and the centre disc opening.
- Do not stick labels or tape onto the discs.
- If you do not use the device for a long time, remove the disc from it and place into its cover.
- Be careful not to leave the fingerprints or scratches on the disc.

### Notes:

- Do not write on the printed side with a ball-point pen or pencil. To label a disc use soft tip markers specially designed for this purpose and label the label side of the disc.
- Do not use scratch-proof protectors or covers.
- Do not use discs printed with label printers available on the market.
- Do not load warped or cracked discs.

## Cleaning disc

- Fingerprints and dust affect the quality of the image while playing the recording from the disc. Before playing the disc remove them by cleaning the disc with a soft lint-free cloth.
- Do not use any type of solvent, such as thinner, benzol (benzene), commercial cleaning agents or antistatic sprays.

## Storage discs

Be careful not to harm the disc because the data on these discs is highly vulnerable to the environment.

- Do not store discs on direct sunshine or near heat sources. Do not leave the disc in locked car parked on the direct sunshine. There is a risk of disc deformation.
- Store in a cool ventilated place.
- Store vertically.
- Store in a clean protective cover.
- If you move your disc player suddenly from a cold place to a warm place, condensation may generate on the operating parts and lens and cause abnormal disc playback. If this occurs, do not connect the plug to the power outlet and wait for two hours. Then insert the disc and try to play back again.

## Supported disc formats



This information informs the user that the player can play back DVD-RW recordings in VR format (Video Recording).

### Notes:

1. Depending on the recording media, recording method (used PC program used for the disc recording) and its finalization, it is possible that it will not be possible to play some CD-R or DVD+/-RW/R discs.
2. Do not stick any stickers or labels on either side of the disc (the side with the printed label or the side with the recording)
3. Use the player to play only circular discs - when playing irregular shaped discs there is a risk of damaging the disc or the player.
4. Some DVD and Video CD playback operations may be intentionally programmed by the producer of the software. This device plays DVD and Video CD discs according to the disc contents created by the producer of the software and so some playback functions may not be available, or conversely there may be additional functions available.

Made under a license from Dolby Laboratories, Inc. "Dolby", "Pro Logic" and the double D icon are registered trademarks of Dolby Laboratories, Inc.





### Region code

This player is intended for playing DVD video designated by the code for region ALL (discs designated in this way can be played by all DVD players). You can find the region code of the disc on its label, the region code of the player is located on its rear or under side. After inserting a DVD with a different than the above mentioned region code into the player a message will appear on the screen "Check region Code" and the playback of the DVD will be rejected.

### Serial number

Serial number of device is a unique figure clearly identifying your device. Please write below the serial number of your device together with other important data for clear identification of your device.

Serial number: \_\_\_\_\_

Purchase date: \_\_\_\_\_

## 1.5 Accessories

- Car adapter
- Power adapter
- Remote control
- Earphones
- Car bag
- Instruction manual
- Warranty card

## 2. Description of device

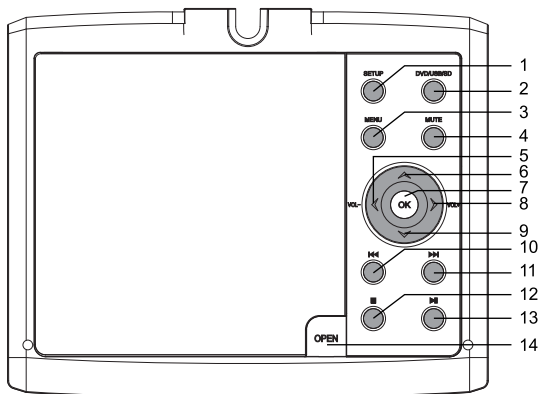

- |                                       |                                      |
|---------------------------------------|--------------------------------------|
| 1. SETUP button (settings)            | 8. ► / VOL+ button (increase volume) |
| 2. DVD/USB/SD button (change source)  | 9. ▼ button                          |
| 3. MENU button                        | 10. ◀◀ button (previous)             |
| 4. MUTE button (mute the sound)       | 11. ▶▶ button (next)                 |
| 5. ◀ / VOL - button (decrease volume) | 12. ■ button (stop)                  |
| 6. ▲ button                           | 13.    button (play/pause)           |
| 7. OK button                          | 14. OPEN (open the disk drive)       |

### Right side

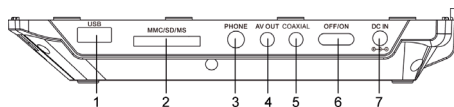

- |   |                            |
|---|----------------------------|
| 1. USB port   | 4. AV OUT (AV output)      |
| 2. MMC/SD/MS card slot                              | 5. COAXIAL (digital sound) |
| 3. PHONE jack (connecting earphones/<br>headphones) | 6. ON / OFF switch         |
|   | 7. DC IN 9V power jack     |

### 3. Remote control

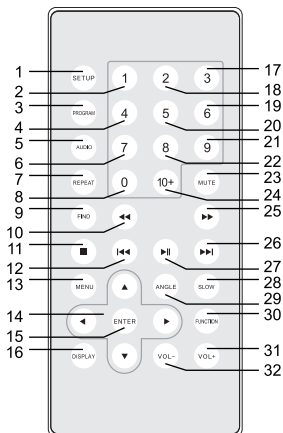

- |                                    |                              |
|------------------------------------|------------------------------|
| 1. SETUP button (setup)            | 17. 3 button                 |
| 2. 1 button                        | 18. 2 button                 |
| 3. PROGRAM button                  | 19. 6 button                 |
| 4. 4 button                        | 20. 5 button                 |
| 5. AUDIO button (sound background) | 21. 9 button                 |
| 6. 7 button                        | 22. 8 button                 |
| 7. REPEAT button                   | 23. MUTE button (sound mute) |
| 8. 0 button                        | 24. 10+ button               |
| 9. FIND button                     | 25. ►► button (fast forward) |
| 10. ◀◀ button (fast backward)      | 26. ►► button (next)         |
| 11. ■ button (stop)                | 27. ►► button (play)         |
| 12. ◀◀ button (previous)           | 28. SLOW button              |
| 13. MENU button (disc menu)        | 29. ANGLE button             |
| 14. Direction buttons              | 30. FUNCTION button          |
| 15. ENTER button                   | 31. VOL+ button              |
| 16. DISPLAY button (display)       | 32. VOL- button              |

#### Note:

If you need to use **REPEAT** (repeat playback), **A-B**, **ANGLE** (angle), **SLOW** (slow playback), **PRGM** (program playback), **AUDIO** (sound), **ZOOM** or **TITLE** functions, you should press **SHIFT** button first as these functions are in combination with numeric buttons. If you want to use numeric buttons, press **SHIFT** button again.

## Using the remote control

1. To control the device using the remote control, point the remote control at the device and then press the button with the required function. The effective range of the remote control is up to 7 meters with a max deviation of  $\pm 30^\circ$  from the perpendicular direction to the reception sensor of the remote control on the front side of the device. The falling capacity of the batteries gradually reduces the remote control range.
2. There must be no solid obstacles in the area between the remote control and the device when the remote control is being used.
3. During standard use the lifetime of batteries in the remote control is about 1 year. When the effective range of the remote control is substantially reduced, or when there are problems with its use, change both the batteries in the remote control.
4. If you will not be using the remote control for a longer period of time, take out both batteries - in this way you will prevent potential damage caused by their leakage.

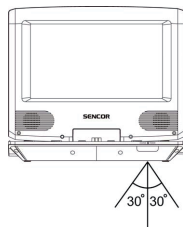

### Note:

If you get stored the device or you do not using for a long time, remove the batteries.

## 4. Basic operation

### 4.1 Installation

1. After unpacking and discarding all packaging and promotional materials check if the packaging contains all accessories that are stated in this manual (see the previous part of the manual).
2. Using the supplied power adapter connect the device with power outlet. Use only the supplied adapter.
3. Open the screen panel where the screen is situated. The screen can be opened to a maximum angle of  $180^{\circ}$  and it can be rotated to an angle of  $270^{\circ}$ .
4. To open the disc drive cover, press the **OPEN** button. Insert a disc with label side facing upward and close the cover. Now, the device is ready to play back.

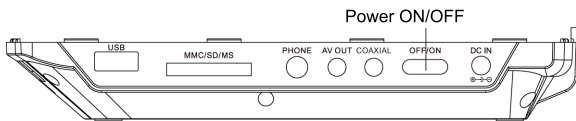

#### Important notice

**Before connecting or disconnecting any device ensure at first that both devices have been switched off and unplugged from the power outlet.**

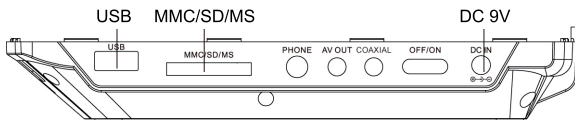

### 4.2 Connecting USB device / MMC/SD/MS card

- Insert an USB device into the USB port. Press **DVD/USB/SD** on the control panel on the device or **DVD/SD/USB** button on the remote control and select USB option.
- Insert a MMC/SD/MS card into the MMC/SD/MS slot. Insert the card correctly, do not use strong power when inserting. Press **DVD/USB/SD** on the control panel on the device or **DVD/SD/USB** button on the remote control.

#### Note:

If there is no USB drive or MMC/SD/MS card inserted into the device, the device will automatically shows DVD menu.

### 4.3 Connecting earphones

1. Connect earphones with 3.5mm jack into the PHONE jack.
2. Using **VOL+ / VOL-** adjust the volume.

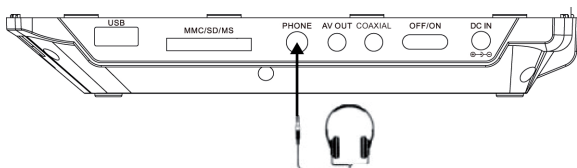

**Note:**

Do not use the earphones / headphones at high adjusted volume. Risk of damage or lost of hearing when listening for a long time.

### 4.4 Connecting COAXIAL

For digital audio output signal. Available only for DVD.

### 4.5 Connecting to external equipment

You can connect the device to an external amplifier or home cinema using the AV OUT jack.

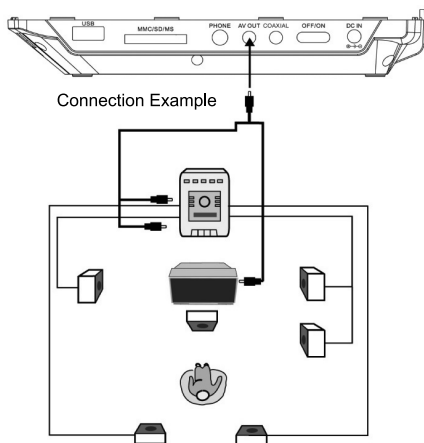

**Note:**

Adjust the volume of your speakers to a comfortable listening level to avoid any damage. When connecting or disconnecting the DVD player, switch off the amplifier to avoid damaging of speakers.

## 5. Playback

### 5.1 Disc playback

1. Press the **OPEN** button to open the disk drive cover.  
(If the disc has been inserted and it is turning, wait until it stops completely.)
2. Insert a disc with label side facing upward on the centre pin and slight press down to secure the disc.
3. Close the cover.
4. Slide the **ON/OFF switch** to **ON** position to switch on the device.
5. Press **OK** button or **▼▲◀▶** button on the remote control to start playing the disc. DVD-Video disc will start automatically.

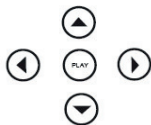

#### Pause playback

If you need to pause the playback, press **▶||** button on the control panel of the device or press **||/STEP** button on the remote control. The playback will.

To continue in playback, press **▶||** button on the control panel of the device or press **PLAY** button on the remote control. Repeat press of **||/STEP** button on the remote control provide **STEP** playback, frame by frame.

#### Stop playback

If you need to stop playing, press **■** button on the control panel of the device or press **■** button on the remote control. When you activate the Memory function (Last Memory) in the setup menu of the device, then press **■** button once to stop playback and the position will be saved in the memory; pressing **PLAY** button, you will resume the playback from that point. Press **■** button for the second time and the position will be deleted from the memory and if you press **PLAY** button next time, the playback will start from the beginning.

#### Note:

The device can be charged when playback.

#### Start playback from menu

Press **TITLE** or **MENU** button to enter the basic menu. (Not all discs contain both menus, that is determined by a disc manufacturer.)

Using the direction buttons or numeric buttons select the desired title/chapter/track.

Press **ENTER** button to start playback of the desired title/chapter/track.

#### STEP playback (STEP)

During playback, press **||/STEP** button on the remote control to enter the **STEP** playback mode (frame by frame). Each press of **||/STEP** button will advance the playback by one frame.

To resume normal playback, press **▶||** button on the control panel of the device or press **PLAY** button on the remote control, or press **ENTER** button.

The sound will be muted when **STEP** playback.

### Fast forward / rewind

During playback, press **◀◀** button on the control panel of the device or on the remote control for fast rewind. Each press of **◀◀** button will change the speed of rewinding as following: 2x → 4x → 8x → 16x → 32x → normal playback.

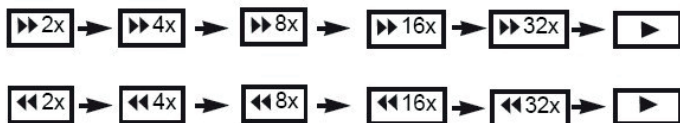

During playback, press **▶▶** button on the control panel of the device or on the remote control for fast forward. Each press of **▶▶** button will change the speed of forwarding as following: 2x → 4x → 8x → 16x → 32x → normal playback.

#### Note:

This function is not supported on all discs.  
The sound will be muted when fast forward/rewind.

### Slow playback

During playback, press **SLOW** button to enter slow playback mode.

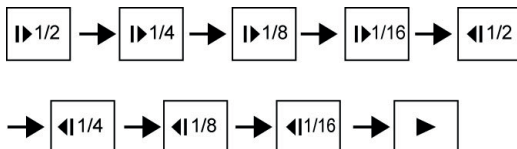

Each press of **SLOW** button will change the speed of slow playback as following: 1/2, 1/4, 1/8, 1/16, normal playback.



#### Note:

This function is not supported on all discs.  
The sound will be muted when slow playback.



## 5.2 Picture CD/JPEG playback

1. Insert Picture CD / JPEG disc into the device. It will start playback automatically once loaded.
2. Select a folder or picture/track contained on the disc and menu will appear on the screen. Using **up / down** buttons select the desired folder and press **ENTER** or **PLAY** button to enter the folder.
3. Select the play mode. Press **REPEAT** button to select the play mode. Using **up/down** select the desired track.
4. Press **ENTER** or **PLAY** button start playback.
5. Press **■** or **MENU** button to display JPEG folders and files.
6. During playback, press **ZOOM** button on the remote control to change the picture size as following:  $\oplus 2x \rightarrow \oplus 3x \rightarrow \oplus 4x \rightarrow \oplus 1/2x \rightarrow \oplus 1/3x \rightarrow \oplus 1/4x \rightarrow$  normal view.  
During playback, load the picture and press **ZOOM** button to change the picture size as following: Zoom 100%  $\rightarrow$  Zoom 125%  $\rightarrow$  Zoom 150%  $\rightarrow$  Zoom 200%  $\rightarrow$  Zoom 75%  $\rightarrow$  Zoom 50%  $\rightarrow$  Zoom 100% (normal size).

### Note:

You can create your own Picture CD disc by saving pictures on CD-R disc in JPEG format.

### Searching title, chapter or track

DVD disc are normally divided into titles which are sub-divided chapter and moreover, into tracks.

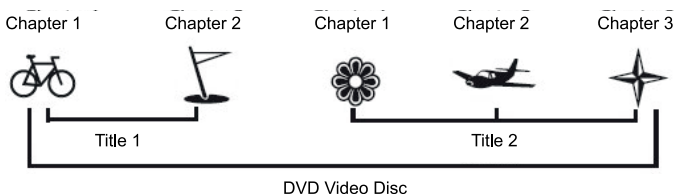

If your DVD disc contains title menu, you can find the desired title, chapter or track.

1. Press **MENU** button. The desired menu will display.
2. Using the direction buttons select the desired title. The title can be select using the numeric buttons or **◀◀/▶▶** buttons.
3. Press **ENTER** button. The playback starts from the selected title, chapter or track.

### Repeat playback

The player allows you to play back the desired title, chapter, and track or segment repeatedly.

During playback, press **REPEAT** button. Each press will change the repeat mode as follows.

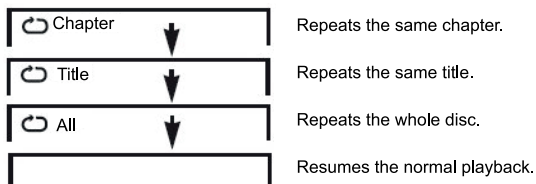

### Repeat playback of specific segment

1. During normal playback, press **A-B** button to mark the starting point of repeat playback (A).
2. Press **A-B** button again to mark the end point of repeat playback (B). The player will play the selected segment A-B repeatedly.
3. Press the button again to cancel the repeat mode. Normal playback will resume.

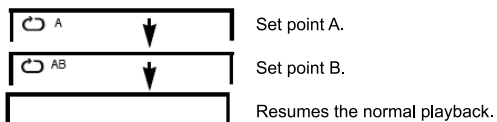

### Program playback

1. Press **PRGM** (PROGRAM) button to display the program playback menu.

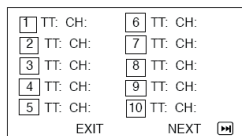

2. Using numeric buttons, select the title, chapter or track which you wish to program. The selected numbers will be inserted into the list.
3. Once finished the program list, highlight **START** icon and press **ENTER** or **PLAY** button to play the program playback.
4. To cancel the program playback, move the cursor to **STOP** and press **ENTER** or **PLAY** button to confirm.

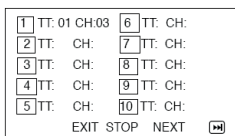

## 6. Using OSD

### 6.1 Checking the operational status

Using this function, you can view the following: current title – track number – total playing time.

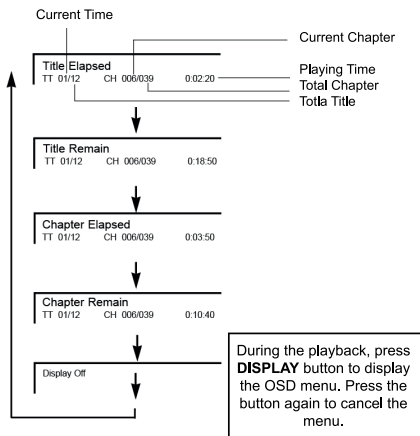

### 6.2 Selecting the camera angle

The player allows you to display the scenes from different angle provided that the inserted disc contains multi-angle scenes.

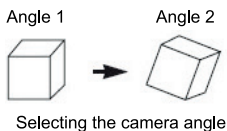

Press **SHIFT** button and then **3/ANGLE** to display the scene from different angle.

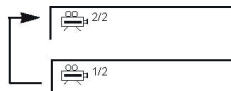

**Note:**

If you insert a disc which does not contain any scenes from different angle this function will not work.

## 7. Setup menu

### 7.1 Setting the parental lock

The player supports the parental lock function provided that the disc supports this function as well.

DVD discs which are equipped with the parental lock function are rated according to their content. The parental lock level may vary disc by disc. Hence, if the disc supports this function, you can edit the parts which are not suitable for children and replace these parts with more suitable, or you can lock whole content of such disc.

1. Press **SETUP** button to display the setup menu.
2. Using direction buttons, select **Preference Page** (Preference Menu).

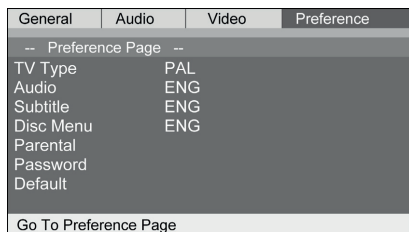

3. Select **Parental** (Parental lock) item and press **ENTER** or **PLAY** button.
4. Select rating and press **PLAY** button.



5. Insert valid password and press **PLAY** button. The default password is 123456.

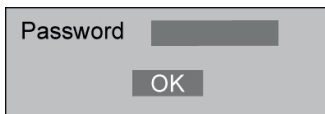

6. Press **SETUP** button to exit the menu.

## 7.2 Password change

1. Press **SETUP** button to display the setup menu.
2. Using direction buttons, select **Preference Page** (Preference Menu).
3. Select **Password** (Password) item and press **ENTER** or **PLAY** button.
4. Insert old password.
5. Insert new password.
6. Inset the new password again to confirm.
7. Press **ENTER** or **PLAY** button to confirm.
8. Press **SETUP** button to exit the menu.



## 7.3 Custom function setting

1. Press **SETUP** button to display the setup menu.
2. Using direction buttons select the desired item and press **ENTER** or **PLAY** button.
3. Press **SETUP** button to exit the menu.

General Setup (General setup)

General	Audio	Video	Preference
-- General Setup Page --			
TV Display		Wide	
Angle Mark		On	
OSD Lang		ENG	
Screen Saver		On	
Last Memory		Off	
Go To General Setup Page			

Audio Setup (Sound)

General	Audio	Video	Preference
-- Audio Setup Page --			
Dual Mono			
Dynamic			
Go To Audio Setup Page			

Using direction buttons to select and set the value of each item menu.

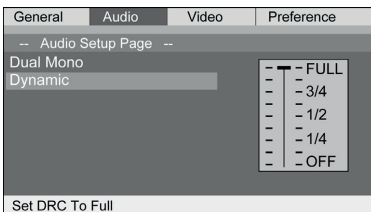
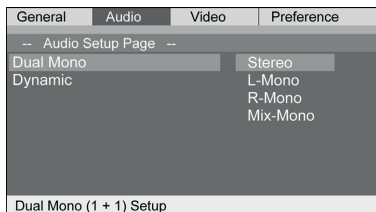

### Video Setup (Picture)

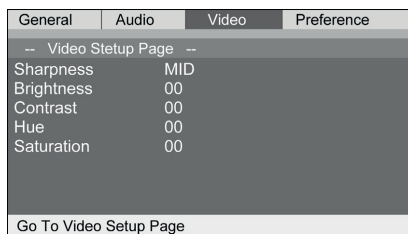

### Note:

To enter the setup menu, the device should be in stop mode.

## 8. Troubleshooting guide

Symptom	Solution
No power.	Check whether the device is correctly connected to the power outlet using the power adapter. Check whether the battery is not empty.
No picture / sound.	Ensure the device is correctly connected; volume is correctly set; connected device or TV works properly; audio output is correctly set.
The player does not start playback.	The DVD+-RW disc is empty. Insert disc with data. Insert disc with label side facing upwards. Check the disc. Ensure the disc is clean, without scratches or dust. Clean the disc. Ensure the region code is „ALL“. Check the parental control rating or change the rating. (The default password is 123456). Reset the device.

## 9. Technical specifications

### Panel

Diagonal	7" (18 cm)
Resolution	480 x 234

### Power Supply

Adapter	DC 9 V / 1.0 A
Built-in battery	7.4 V (battery can play up to 2 hours)
LED power indicator	Power On: green Charging: red
Charging time	Fast charging: 2.5 – 4 hours (device must be switched off) Slow charging: 6 – 8 hours

### Main features

Card reader	SD / MMC / MS
USB	USB 2.0
Playback disc formats	DVD / DVD+RW/DVD+R/DVD-RW/DVD-R/CD / CD-R / CD-RW
Support Video format	MPEG-1(VCD),MPEG-2(SVCD,DVD),MPEG-4 ,DIVX, XVID, Picture CD
Support Audio format	MPEG1,AC3 DECODE,MP3,MP3-PRO,WMA,LC-AAC,HDCCD,CD-G
Support DivX version	DIVX3.x/DIVX4.x/DIVX5.x/DIVX6 (optional)

### Dimensions and features

Dimensions (l x w x h)	207 x 167 x 42 mm
Weight	0.75 kg

Technical specifications may change without prior notice.



## INSTRUCTIONS AND INFORMATION REGARDING THE DISPOSAL OF USED PACKAGING MATERIALS

Dispose of packaging material at a public waste disposal site.



### DISPOSAL OF USED ELECTRICAL AND ELECTRONIC APPLIANCES

The meaning of the symbol on the product, its accessory or packaging indicates that this product shall not be treated as household waste. Please, dispose of this product at your applicable collection point for the recycling of electrical & electronic equipment waste. Alternatively in some states of the European Union or other European states you may return your products to your local retailer when buying an equivalent new product. The correct disposal of this product will help save valuable natural resources and help in preventing the potential negative impact on the environment and human health, which could be caused as a result of improper liquidation of waste. Please ask your local authorities or the nearest waste collection centre for further details. The improper disposal of this type of waste may fall subject to national regulations for fines.

#### For business entities in the European Union

If you wish to dispose of an electrical or electronic device, request the necessary information from your seller or supplier.

#### Disposal in other countries outside the European Union

If you wish to dispose of this product, request the necessary information about the correct disposal method from local government departments or from your seller.



This product meets all the basic EU regulation requirements that relate to it.

Changes to the text, design and technical specifications may occur without prior notice and we reserve the right to make these changes.

