

SENCOR®

SLE 43F11M4

SLE 48F11M4





LED television Instruction manual

Please read this manual carefully before TV operation. Retain it for future reference. Record model number and serial number of the set. See the label attached on the back cover and quote this information to your dealer when you require service.

Important safety instructions	3
1. Description of the device	8
2. Remote control	9
3. Connection and setting.	11
4. Select input source	13
5. First time setup	14
6. Main Menu Operation	15
6.1 Picture menu	15
6.2 Audio menu	17
6.3 Channel menu	19
6.4 Lock system menu	23
6.5 Setup menu	24
6.6 PC Setting Menu	28
7. USB Operation	30
7.1 Photo	30
7.2 Music	30
7.3 Movie	31
7.4 Text	31
8. Troubleshooting Guide	32
9. Technical Specifications	34

Important safety instructions

If you want to use this product correctly, carefully read this user's manual and store it for future reference. If you give (sell) the device to somebody, please also include all the documentation together with this device, including this user's manual.

	The flash symbol in an equilateral triangle indicates that there is dangerous voltage inside this device, which presents a risk of injury by electrical shock.
	The exclamation mark in an equilateral triangle symbol indicates important operating or servicing instructions in the device's documentation.
To reduce the risk of injury by electrical shock do not remove the cover (or the rear side). There are no components inside which the user can repair. Have all repairs or adjustments performed at an authorised service centre.	

GENERAL SAFETY INSTRUCTIONS

- Carefully read this manual before using the device. Follow the instructions contained in this user's manual.
- Heed all warnings.
- Adhere to all instructions.
- Use only accessories determined by the manufacturer.
- **AN OPEN FLAME MUST NOT BE PLACED ON THE DEVICE, E.G. A BURNING CANDLE. DO NOT PLACE HOT ITEMS OR OBJECTS WITH AN OPEN FLAME E.G. CANDLES OR NIGHT LAMPS ON OR IN THE VICINITY OF THE DEVICE. HIGH TEMPERATURES MAY MELT PLASTIC PARTS AND CAUSE A FIRE.**
- Use the device in a temperate climate zone.
- Neither the manufacturer nor the vendor of the device under no condition takes responsibility for any direct or indirect damages caused by not adhering to instructions for installation, set-up, use, servicing or cleaning of this device as described in this user's manual.
- Protect the device against being knocked, dropped, hit, shaken and against vibrations, humidity and dust.
- Before allowing children to use the device, they must be appropriately to their age, informed about the correct and safe use of the player.
- If the device is equipped with a headphone jack, do not use headphones set to an extreme volume. There is a danger of hearing damage or loss.

Installation, operation

- Install the device according to the instructions in the user's manual.
- Leave free space on all sides of the device, necessary for proper air circulation. This removes the heat created during operation. Covering the ventilation openings of the device's case creates a risk of overheating or damaging the device. It is necessary to ensure that the ventilation openings are not blocked, e.g. by a newspaper, table cloth, curtain, etc. Follow the installation instructions in the user's manual.
- This device should not be located in a confined area such as a bookshelf or rack, if sufficient ventilation is not provided for or the instructions of the manufacturer are not followed.
- Never insert any items into any ventilation or other openings because they could come into contact with points with dangerous voltage levels or cause a short circuit of parts, which could cause a fire or injury by electric shock. Never pour any liquid into the device.
- Do not install the device in direct sunlight or near sources of heat, such as heaters, heat exchangers, stoves or other appliances (including amplifiers) producing heat. High temperatures significantly reduce the lifetime of electronic components in the device. Do not use or leave the device in the vicinity of an open fire.

Important safety instructions

- The device must not be exposed to dripping or running water and objects filled with water must not be placed on it, e.g. vases. Protect the device against rain, spray or contact with any other liquid, do not leave or install the device outdoors. Do not use the device outdoors. Not adhering to these instructions creates a risk of electrical shock or fire hazard.
- Do not use this device near water.
- Treat the glass panel and device cover with care. The screen glass can break on impact and cause serious injuries.
- Make sure that the power cord is not stepped on or compressed, particularly near the power plug, power socket and at the point where it exits the device or the adapter. The power plug (adapter) is used as a disconnection device and must be easily accessible.
- Never use a device with a damaged power cord or plug. If the power cord or plug are damaged, turn off the device, disconnect it from the power source and contact an authorised service centre. A damaged power cord or plug may only be replaced by qualified personnel. Under no circumstances attempt to replace the power cord or plug yourself.
- Do not attempt to circumvent the polarised power plug safety feature. If the power plug cannot be inserted into your power socket, contact a qualified electrician to replace the old type of power socket.
- Before connecting the device into a power socket, check that the voltage in your power socket corresponds to the voltage on the rating label of the device or on its power adapter. If you are not certain about the type of the power sources in your home, contact your retailer or the local energy company.
- Before turning on the device, check that the electrical connection is performed properly and in accordance with the instructions of the manufacturer. Before connecting or changing the connection, turn off the device and disconnect it from the mains.
- Remember to always disconnect the power plug (adapter) from the power socket before disconnecting the power cable from the back side of the device.
- Insert the power plug into a independent power socket. Do not overload wall sockets with extension cords or multi-socket adapters. There is a risk of injury by electric shock.
- When disconnecting, hold the power cord by the plug and not by the cord itself.
- Disconnect the device from the power socket during storms or if you will not be using it for a longer time.
- Avoid moving the device from a cold environment to a warm one or vice versa, or when using the device in a very humid environment. Air humidity may condense on some components inside the case of the device and the device may stop working temporarily. If this occurs leave the device in a warm and well ventilated place and wait 1 – 2 hours until the moisture evaporates and the device can once more be used as usual. Take care especially during the first use of the player immediately after its purchase during a cold season.
- Do not place this device on an unstable cart, pedestal, stand, bracket or table. The device could fall and cause serious injuries to children or adults or could be seriously damaged or damage other items. Only use the device with a cart, pedestal, stand or table designated by the manufacturer or sold with the device. Any mounting of the device should be carried out according to the manufacturer's instructions and the mounting accessories recommended by the manufacturer should be used.
- Do not lean on the device, do not lean over it or use it as a step. Protect it against violent movements. Ensure that children do not play with the device.



If using the cart, be careful when moving it. Stopping suddenly, excessive force and uneven surfaces could cause the cart to fall over with the device.

- Neither the manufacturer nor the vendor of the device under no condition takes responsibility for any direct or indirect damages caused by not adhering to instructions for installation, setup, use, service or cleaning of this device as described in this user's manual.
- Protect the device against being knocked, dropped, hit, shaken and against vibrations, humidity and dust.
- Do not expose the device to extreme temperatures or humid conditions.

Note:

If the device is powered by an adapter, use only the adapter and AC power cord supplied with the device. Do not use faulty power sockets. Check that the power plug is properly inserted into the power socket. If the power plug is loose, arching could result in a fire. Contact a qualified electrician to have your socket replaced.

Note:

Only connect the device to a properly grounded socket with a protective grounding pin.

Note:

If you will be installing the device on a wall or to the ceiling, follow the manufacturer's instruction found in the user's manual of the particular device.

Repairs and maintenance

- To prevent risk of injury through electric shock or the creation of a fire, do not take the device out of the case - there are no parts inside the case repairable or adjustable by the user without relevant equipment and qualifications. Should the device require adjustment or repair, contact a professional service centre.
- In the case of any unusual events occurring during the use of the device, e.g. if there is a distinct smell of burning insulation or smoke comes out of the device, immediately turn off the device, disconnect the device from the power source and do not use the device until you have received the results of an inspection by the employees of the professional service centre.
- Have all repairs carried out by qualified personnel. Repairs are necessary if the device has been damaged in any way, for example if the power cord is damaged, liquid was poured on the device, foreign objects have entered the device, the device has been exposed to rain or moisture, if the device is not working as usual or if it has fallen.
- In the event of repair or replacement of a part of the device, ensure that the service technician uses components designated by the manufacturer or that these components have the same specifications as the original ones. Unauthorised replacements could cause a fire, lead to a danger of injury by electrical shock or other dangers.
- Before cleaning, carrying or other maintenance, disconnect the plug (adapter) from the power socket.
- Clean the device only with a dry cloth.
- For cleaning do not use petrol, thinners or any other solvents or use any abrasive cleaning agents, steel wool or any sponges with steel wool.

Note:

Do not throw the device into ordinary household waste. For disposal follow all local laws and regulations.

Remote control and batteries

- Do not expose the remote control or the batteries to direct sunlight or sources of heat, such as heaters, heat exchangers, stoves or other appliances (including amplifiers) that produce heat. Do not use or leave the device in the vicinity of an open fire.
- Ensure that the sensor is not exposed to a strong light source (e.g. sunlight) or light from fluorescent light tubes, which could reduce the effectiveness and reliability of the remote control.
- Neither the remote control nor the batteries may be exposed to dripping or running water and objects filled with water must not be placed on them, e.g. vases. Protect against exposure to rain, spraying or pouring of any kind of liquid. Do not use outdoors. Not following these instructions creates a danger of damage to the remote control or the battery.
- Do not use this device near water.
- It is necessary to pay attention to the environmental impact aspects of battery disposal.
- The incorrect use of batteries may cause the leakage of the electrolyte and corrosion. To ensure that the remote control works correctly, proceed according to the instructions below:
 - Do not insert the batteries in the wrong polarity orientation.

Important safety instructions

- Do not charge, heat, open or short circuit the batteries.
- Do not throw batteries into a fire.
- Do not leave discharged batteries in the remote control.
- Do not combine various types of batteries or new and old batteries.
- If you will not be using the remote control for a longer period of time, remove the batteries to prevent potential damage caused by a subsequent battery leakage.
- If the remote control is not working correctly or its operational range is reduced, change all batteries for new ones.
- If electrolyte leaks out from the batteries, have the remote control cleaned by an authorised service centre.

Attention: To prevent a fire hazard or injury by electrical shock, do not expose this device to rain or humidity.

Attention: Batteries must not be exposed to excessive heat, for example sunlight, fire, etc.



This symbol indicates that the device has double insulation between the dangerous mains voltage and the parts accessible to the user. In the case of servicing use only identical spare parts.

SENCOR® Appendix to LCD TV Instruction Manual

Precautions When Still Image is Displayed, Red/Blue/Green/Black spots on the screen

A still image may cause permanent damage to TV screen

- Do not display still image on the LCD panel for more than 2 hours as it can cause screen image retention. This image retention is known as "screen burn". To avoid such image retention, reduce the degree of brightness and contrast of the screen during still image watching.
- Similar "screen burn" effect can appear on the LCD panel due to still TV channel logo displaying.
- Watching TV in 4:3, 16:9 or similar modes which doesn't cover whole screen for long period of time may leave traces of borders displayed on the left, right or center of the screen caused by the difference of light emission on the screen. Playing a DVD or a game console can cause a similar effect to the screen.
- Displaying still images from video games and PC for longer than a certain period of time may produce partial after-images. To prevent this effect reduce the brightness and contrast when displaying still images.



Damage caused by above reasons is not covered by the Warranty!

There may appear red spots, blue spots, green spots and black spots on the screen

- This is a characteristic of liquid crystal panels and is not a problem. The liquid crystal panels are built with very high precision technology giving you fine picture details. Occasionally a few non-active pixels may appear on the screen as fixed point of red, green, blue or black (up to 0.001% of total display pixels). Please note this doesn't affect the performance of your LCD TV.

Notes on the USB connector:

USB flash drives must be inserted into the device directly. To prevent data transmission failure or its interference do not use USB extension cables. Electrostatic discharges may cause the device to malfunction. In such an event the user must restart the device.

Before using a USB flash drive test its ability to communicate with the device and its data reading and writing speed.

To achieve the maximum reading speed we recommend that you keep the disk space defragmented. Use the FAT32 file system, a single partition, without protection. If reading and writing on the USB flash disk is not continuous, undesirable effects may occur such as partial image loss (distortions/checkering effects) or complete image loss, audio defects, and in extreme cases the operation will be stopped. Unexpected behaviour of the connected flash drive, or the presence of viruses or other damaging software may cause the functions of the device to stop working, necessitating a restart.

The USB connector is the standard type and is not able to power a USB device with a high power usage (e.g. hard disk drives HDD). Use devices with independent power supplies and power them from their own power supplies.

The device was designed to achieve maximum compatibility with flash drives. With respect to the variety of devices on the market it is not possible to guarantee compatibility with every USB device. In the event of difficulties try formatting the flash drive directly in the appliance. If problems persist, use a different flash drive.

Due to the wide range of USB devices available on the market it is not possible to guarantee the compatibility of the device with all USB devices.

Serial number of the device

The serial number of the product is unique and unequivocally identifies your device. Enter the serial number of your device together with other details necessary for the definite identification of your device below.

Serial number: _____

Date of purchase: _____

Description of the device

1. Description of the device

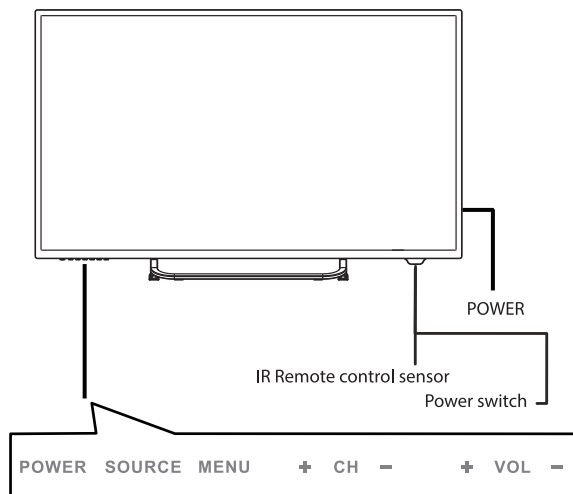

1. **Standby button**
Turns the television on from the standby mode.
2. **INPUT button**
Press to select the desired input.
3. **MENU button**
In TV mode, it displays the LCD television's main menu.
4. **CH +/- button**
Press to switch between individual channels.
5. **VOL +/- button**
Press to increase/decrease the volume.
6. **IR remote control sensor**
Point the remote control at this sensor.
7. **Power indicator**
The green colour indicates the power on mode, the red colour indicates the standby mode.
8. **Main power button**
Serves to turn the television on or off.

2. Remote control

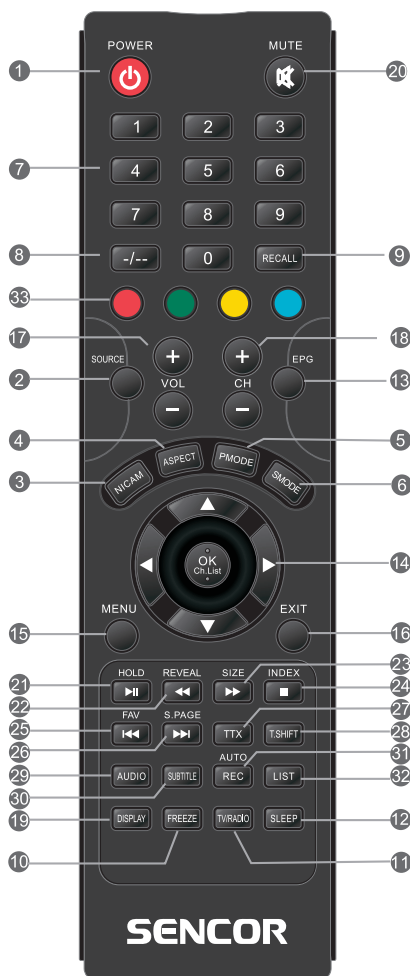

1. POWER button

Turns the television on from the stand-by mode.

2. INPUT button

Press to select the desired input.

3. NICAM button

NICAM/A2 input or output.

4. ASPECT button

Page aspect ratio selection, e.g. 16:9, Zoom, Auto, 4:3

5. P.MODE button

Repeatedly press to select a picture mode.

6. S.MODE button

Repeatedly press to select a sound mode.

7. Numerical buttons 0-9

Press 0-9 to directly select a TV channel while watching the TV. In teletext mode enter the page number, etc.

8. --/ button

It is used to enter channel numbers with various digit counts, e.g. for 1 – 11 – 111.

9. RECALL button

Button for switching to the previously watched channel.

10. FREEZE button (freeze)

Freeze the picture

11. TV/RADIO button

Switching between the television and radio modes.

12. SLEEP button

Set the automatic shut off time for the television.

13. EPG button

Press to show/hide the electronic program guide.

14. ////ENTER buttons

Used for navigating in a menu on the screen and for setting up the television according to your preferences.

15. MENU button

In TV mode, it displays the LCD television's main menu.

16. EXIT button

Function for exiting a menu or a screen.

17. VOL+/- buttons

Press to increase/decrease the volume.

18. CH +/- buttons

Press to switch between individual channels.

19. DISPLAY button

Button for displaying the source and information about channels.

20. MUTE button

Press to mute the sound. Press it again to renew the sound or press VOL +.

21. HOLD/▶|| button

HOLD button: hold the current display
In the MEDIA mode: Playback/pause or start a time shift recording

22. REVEAL/◀◀ button

REVEAL button: Press REVEAL to display or hide hidden teletext information (depends on the broadcast).

◀◀ button: fast rewind

23. SIZE/▶▶ button

SIZE button: Press SIZE to change the size of the screen in the MEDIA mode.

▶▶ button: fast forward

24. INDEX/■ button

INDEX button: call up a teletext content page.
■ button: Stop recording / playback.

25. I◀◀ button

In the MEDIA mode: skip to the previous track

26. FAV button

Press in the TV mode to enter/exit the favourites menu.

27. S.PAGE/▶▶▶ button

S.PAGE button: Press S.PAGE to enter a teletext subpage.

▶▶▶ button: skip to the next track

28. TTX button

Turn teletext on or off.

Note: The teletext function is optional and the availability of buttons depends on the model. Teletext information fully depends on the operator of the channel.

29. T.SHIFT button

It is used to start recording with a time shift (i.e. time shift). Function is only available in the DTV mode.

30. AUDIO button

DTV/MEDIA mode: select a background sound, if available.

ATV mode: select a sound mode: Stereo/Dual I / II/Mono.

Other sources: select the left / right channel

31. SUBTITLE button

Button for showing / hiding subtitles in the bottom part of the screen, if they are available.

32. AUTO / REC button

AUTO button: Used for automatic configuration in the PC mode.

REC button: Press to start recording. (only in the DTV mode.)

33. LIST button

It is used to enter / exit the channel list menu and other PVR functions.

34. RED, GREEN, YELLOW, BLUE buttons:

corresponds to various function colors in the menu or teletext. USB MEDIA: BLUE button - repeat mode set and movie subtitle coding selection.

Note:

Remove battery during storage or when you are not using the device for a long time.

- To control the device using the remote control, point the remote control at the device and then press the button with the required function. The maximum range of the remote control is about 5 meters with a deviation of up to +/- 30° from the perpendicular direction to the reception sensor of the remote control on the front side of the device. The falling capacity of the batteries gradually reduces the remote control range. There must be no solid obstacles in the area between the remote control and the device when the remote control is being used.
- During standard use the lifetime of batteries in the remote control is about 1 year. When the effective range of the remote control is substantially reduced, or when there are problems with its use, change both the batteries in the remote control. If you will not be using the remote control for a longer period of time, take out both batteries from it – in this way you will prevent potential damage caused by their leakage.
- Avoid strong impact of light (e.g. sunlight or light from strong fluorescent/saving sources) which can reduce the effectiveness and reliability of IR remote control.

Important note:

Button description of the remote control can be provided in two versions, but functions do not change.

- 1) **OK** and **ENTER** buttons – function is identical.
- 2) **●** and **REC** buttons – function is identical.

Connection and setting

Connection and setting

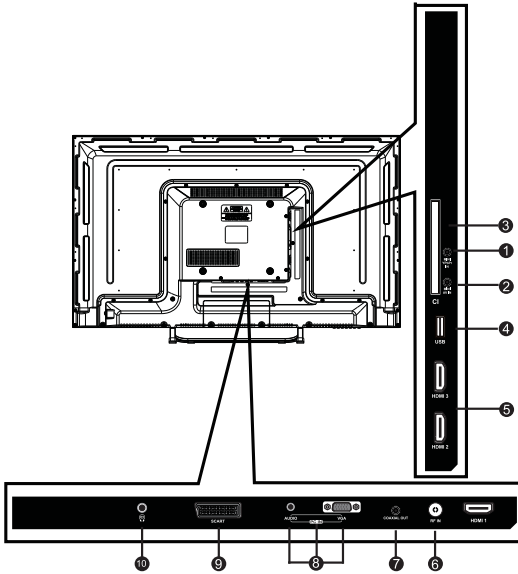

- ❶ MINI YPbPr
- ❷ MINI AV output port
- ❸ CI slot
- ❹ USB port
- ❺ HDMI
- ❻ Antenna connector
- ❼ Coaxial input connector
- ❽ PC input connector
- ❾ SCART input connector
- ❿ Headphone output jack

Stand assembling

- Take the television and the stand out of the box and place the television on a table with the screen facing downwards. We recommend that you put a blanket on the table.
- Mount the stand on the television using 4 screws M4x20 (SLE 43F11M4), M4x12 (SLE 48F11M4).

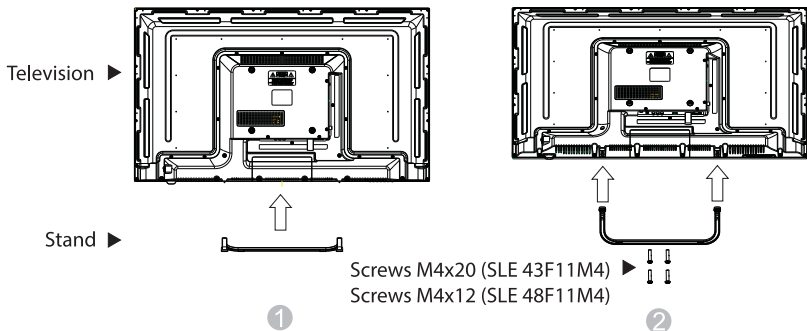

Wall mount (optional)

Wall mount holder is not a part of this packaging.

Before mounting, please disassemble the stand.

Follow the instruction in the instruction book of the wall mount holder.

Cable installation

Please read the instruction manual carefully before installation and use.

1. Take out the TV from the package and put it in a drafty and flat place.

Note:

When you plug or unplug the TV, computer or other equipments, you must make sure that the AC power has been already shut down; when unplugging the power cable or signal cable, please hold the plug (the insulated part), do not draw the body of the cable.

2. The RF output terminal can be connected with the RF input port of the TV.
3. The output AV terminal of DVD can be connected with the AV input port of the TV through AV cable.
4. Connect one end of the VGA cable with the VGA port on computer, connect the other end of the VGA cable with the VGA port on the TV, and tighten the bolts clockwise on the each and of VGA cable.

Note:

While connecting the 15-pin VGA, please do not insert the plug overexertedly, for fear the pin might be broken.

5. Connect one end of the HDMI cable to HDMI device, and connect the other end of the HDMI cable to TV.

Note:

While connecting the HDMI, please aim at carefully, do not insert overexertedly, for fear the pin might be broken.

6. Check and make sure that all AV cables are connected with the corresponding ports correctly.
7. Connect SCART socket input or output from an external device to these jacks.
8. Connect the AC power cable with 100 – 240 V~ power supply.

Note:

The range of power input for the TV is 100 – 240 V ~ 50/60 Hz, do not connect the TV power input port with the AC power out of the above range.

Please hold the insulated part of the plug when you are unplugging the power cable, do not touch directly the metallic part of the cable.

4. Select input Source

Press **INPUT** button to display the input source list,

Press **▼ / ▲** or **INPUT** button to select the input source you want to,

Press **ENTER** button to enter the input source,

Press **EXIT** button to quit.

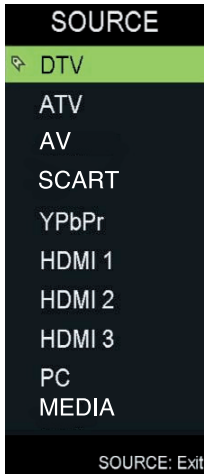

5. First Time Setup

Connect an RF cable from the TV's input called "RF-In" and to your TV Aerial socket.

OSD Language

Press ◀/▶ button to select the language to be used for menus and message.

Mode Setting

Press ◀/▶ button to select mode.

Country

Press ◀/▶ button to select the country you want to.

Antenna Type

Press ◀/▶ button to select Air or Cable.

Auto Scan

Press ◀/▶ button to select Mode: **DTV+ATV, DTV, ATV.**

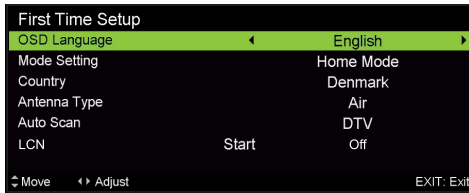

Auto Tuning Status

First tuning digital, press **MENU** button to skip digital tuning, Second tuning analogue, press **MENU** button to skip analogue tuning.

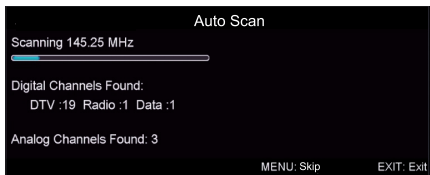
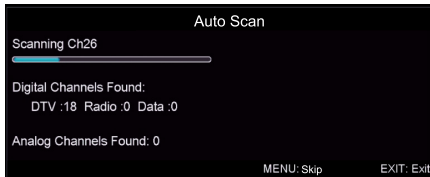

6. Main Menu Operation

6.1 Picture Menu

Press **MENU** button to display the main menu.

Press ◀/▶ button select **PICTURE** in the main menu, then press **ENTER** / ▼ to enter.

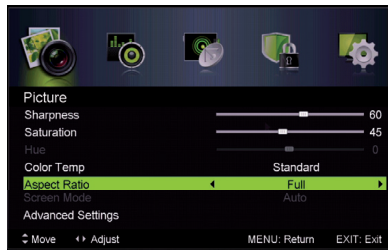
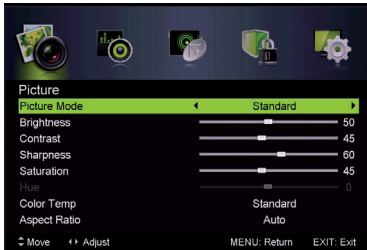

1. Press ▼ / ▲ button to select the option that you want to adjust in the **PICTURE** menu.
2. Press **Enter**/◀ / ▶ button to adjust.
3. After finishing your adjustment, Press **MENU** button to save and return back to the previous menu.

Picture MODE

Press ▼ / ▲ button to select Picture Mode, then press ◀ / ▶ button to select.

(Available Picture mode: Standard, Movie, User, Vivid.)

Brightness/Contrast/ Sharpness/Saturation/Hue

Press ▼ / ▲ button to select option, then press ◀ / ▶ button to adjust.

Brightness Adjust the optical fiber output of the entire picture, it will effect the dark region of the picture.

Contrast Adjust the highlight intensity of the picture, but the shadow of the picture is invariable.

Sharpness Aadjust the peaking in the detail of the picture.

Saturation Adjust the saturation of the color based on your own like.

Hue Use in compensating color changed with the transmission in the NTSC code.

Color Temp

Change the overall color cast of the picture.

Press ▼ / ▲ button to select Color Temp, then press ◀ / ▶ button to select Standard/Cool/Warm.

Standard Produces a vivid image.

Cool Produces a gentle blue-hued image.

Warm Produces a red-hued image.

Aspect Ratio

Press ▼ / ▲ button to select Aspect Ratio, then press ◀ / ▶ button to select.

Auto Automatically adjust Aspect Ratio based on TV size and TV program.

Full/4:3 /Zoom1/Zoom2 To select the available display format.

Main Menu Operation

Screen Mode

Press ▼/▲ button to select HDMI Mode, then press ◀/▶ button to select Auto, Video or PC.
It is available in **HDMI Input** only.

Advanced Settings

Adjust advanced video features to fine tune the picture.

Press ▼/▲ button to select Advanced Settings, then press **Enter** / ▶ button to enter sub-menu.

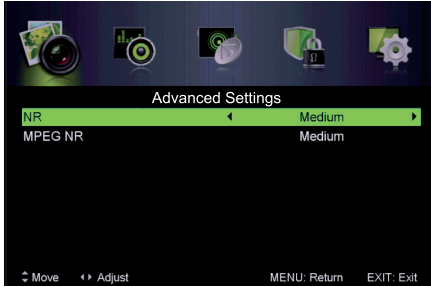

NR

Set options to reduce video noise.

Press ▼/▲ button to select NR, then press ◀/▶ button to select.

- Off Select to turn off video noise detection.
- Week Detect and reduce low video noise.
- Medium Detect and reduce moderate video noise.
- Strong Detect and reduce enhanced video noise.

Mpeg NR

Set options to reduce MPEG noise.

Press ▼/▲ button to select Mpeg NR, then press ◀/▶ button to select.

- Off Select to turn off MPEG noise detection.
- Week Detect and reduce low MPEG noise.
- Medium Detect and reduce moderate MPEG noise.
- Strong Detect and reduce enhanced MPEG noise.

6.2 Audio Menu

Press **MENU** button to display the main menu.

Press ◀/▶ button select **AUDIO** in the main menu, then press **ENTER** / ▼ to enter.

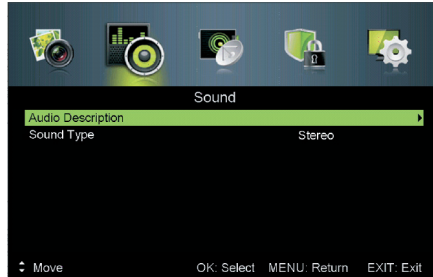

1. Press ▼ / ▲ button to select the option that you want to adjust in the **SOUND** menu.
2. Press **Enter**/◀/▶ button to adjust.
3. After finishing your adjustment, Press **MENU** button to save and return back to the previous menu.

Sound Mode

Press ▼ / ▲ button to select Sound Mode, then press ◀/▶ button to select.

(Available Sound mode: Music, Personal, Movie).

Treble/Bass/Balance

Press ▼ / ▲ button to select option, then press ◀/▶ button to adjust.

Treble Adjust the treble effect. Increases or decreases high-pitched sounds.

Bass Adjust the bass effect. Increases or decreases lower-pitched sounds.

Balance Adjust the balance between left and right speakers to adapt to your listening position.

Surround Sound

Press ▼ / ▲ button to select Surround Sound, then press ◀/▶ button to select On or Off.

EQ Setting

Adjust the curve of 7 bands equalizer.

Press ▼ / ▲ button to select EQ Setting, then press **Enter** / ▶ button to enter sub-menu.

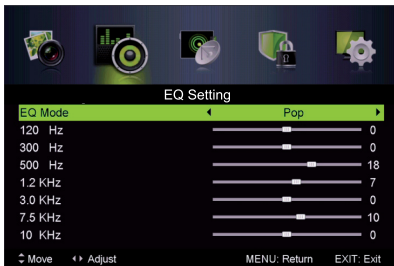

EQ Mode

Press ▼ / ▲ button to select EQ Mode, then press ◀/▶ button to select.

(Available EQ mode: Off, Rock, Pop, Jazz, User).

AVL

Set the auto volume control.

Press ▼ / ▲ button to select AVL, then press ◀/▶ button to select On or Off.

Main Menu Operation

SPDIF

Press ▼ / ▲ button to select **SPDIF**, then press ◀ / ▶ button to select Off / Auto / PCM.

Audio Description

Press ▼ / ▲ button to select Audio Description, then press **Enter** / ▶ button to enter sub-menu.

In it you can turn the Audio Description on (On) or off (Off) and set the volume ratio of a standard audio track and audio description track.

Note:

The audio description is placed in the broadcast by the TV station. Find out which TV stations and which programs have audio description available.

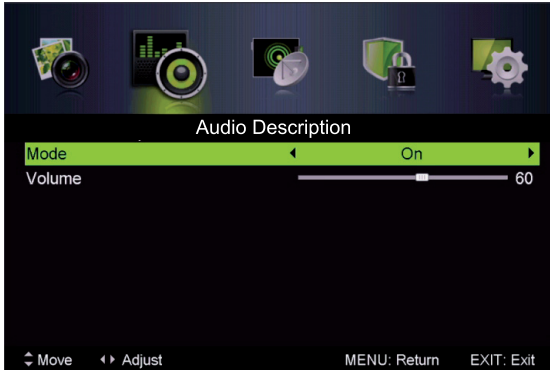

Mode

Press ▼ / ▲ button to select **Mode**, then press ◀ / ▶ button to select On or Off. When the mode is **On**, **Volume** can be adjust by users.

Sound Type

Press ▼ / ▲ button to select Sound Type, then press ◀ / ▶ button to select. (Available Sound Type: Stereo, Dual I, Dual II, Mixed).

6.3 Channel Menu

Press **MENU** button to display the main menu.

Press ◀/▶ button to select **CHANNEL** in the main menu, then press **ENTER** / ▼ to enter.

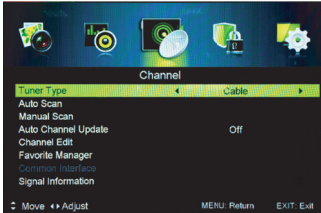

1. Press ▼ / ▲ button to select the option that you want to select in the **CHANNEL** menu.
2. Press **Enter** button to enter sub-menu.
3. Press **MENU** button to return back to the previous menu.

Tuner Type

Press ▼ / ▲ button to select Tuner Type, then press ◀/▶ button to select Antenna or Cable.

Auto Scan

Press ▼ / ▲ button to select Auto Scan, then press **Enter** / ▶ button to enter sub-menu.

Tuner type is **Antenna**

Tuner type is **Cable**

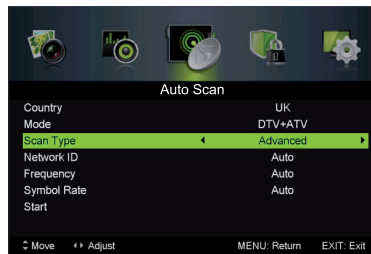
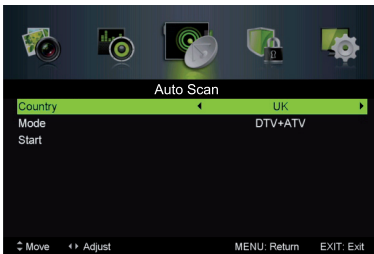

Country

Press ◀/▶ button to select country

Mode

Press ◀/▶ button to select Mode: **DTV+ATV, DTV, ATV**.

Scan Type

Press ◀/▶ button to select Scan Type: **Advanced, Quick, Full**.

Network ID

Press ◀/▶ button to select Network ID: **Auto** or enter digital numbers.

Frequency

Press ◀/▶ button to select Frequency: **Auto** or enter digital numbers.

Symbol Rate

Press ◀/▶ button to select **Symbol Rate: Auto** or enter digital numbers.

Start

Press **Enter** / ▶ button to start the auto searching.

It will search digital channels first, then analog channels.

Before execute auto channel search, please confirm your antenna type is Air or Cable.

Wrong setting of Signal Type maybe cause finding no channel. Found numbers do not include encryption programs.

Manual Scan

Main Menu Operation

Press **▼ / ▲** button to select Manual Scan, then press **Enter / ►** button to enter sub-menu.



Digital Manual Scan

Press **▼ / ▲** button to select Digital Manual Scan, then press **Enter / ►** button to enter sub-menu.

Tuner type is **Antenna**

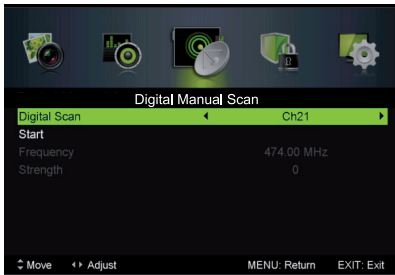

Tuner type is **Cable**

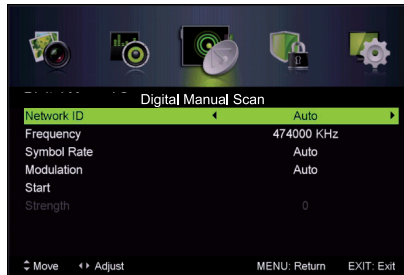

Network ID

Press **◀ / ▶** button to select Network ID: **Auto** or enter digital numbers.

Frequency

Press **◀ / ▶** button to select Frequency: **Auto** or enter digital numbers.

Symbol Rate

Press **◀ / ▶** button to select Symbol Rate: **Auto** or enter digital numbers.

Modulation

Press **◀ / ▶** button to select Modulation: **Auto, 16QAM, 32QAM, 64QAM, 128QAM, 256QAM.**

Start

Press **Enter / ►** button to start the channel searching.

Analog Manual Scan

Press **▼ / ▲** button to select Analog Manual Scan, then press **Enter / ►** button to enter sub-menu.

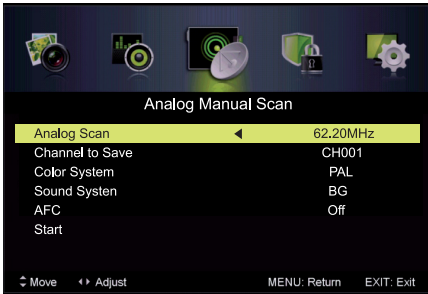

Analog Scan

Press ◀/▶ button to select Analog Scan.

Color System

Press ◀/▶ button to select Color System: Auto, PAL or SECAM.

Sound System

Press ◀/▶ button to select Sound System: Auto, DK, BG, I or L.

Modulation

Press ◀/▶ button to select Modulation: **Auto, 16QAM, 32QAM, 64QAM, 128QAM, 256QAM.**

AFC

Automatic Fine tuning.

Press ◀/▶ button to select On or Off.

Start

Press Enter / ▶ button to start the channel searching.





Main Menu Operation

Channel Edit

Press **▼** / **▲** button to select Channel Edit, then press **Enter** / **▶** button to enter sub-menu.



   The three colored keys are the shortcut key for programming the channel.

First press **▼** / **▲** to highlight the channel you want to delete or move or skip, then:

- Press the **Red** button to delete the channel.
- Press the **Green** button to skip the select channel.
- (Your TV set will skip the channel automatically when using CH+/- to view the channels.)
- Press the **Blue** button to to set the channel to moving state. Then press **▼** / **▲** to move it to the position you want to put.

Common interface

Press **▼** / **▲** button to select Common interface, then press **Enter** button to enter sub-menu.
Only available when there is CI card under DTV.

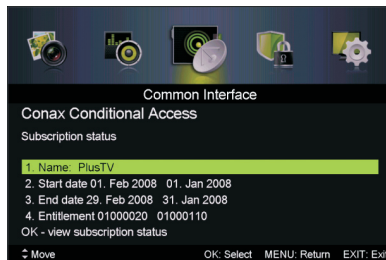
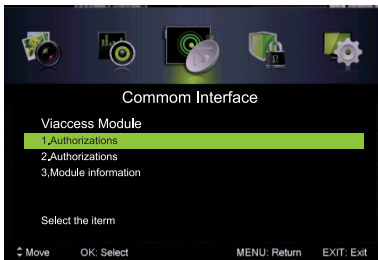

Signal Information

Press **▼** / **▲** button to select Signal Information, then press the **Enter** button to see the detail information about the signal. Only available when there is signal under DTV.

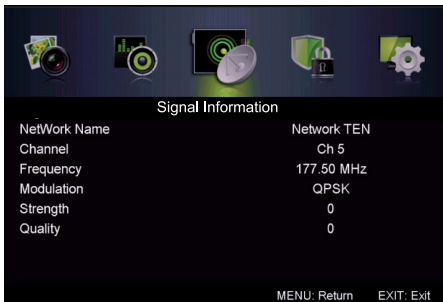

6.4 Lock system Menu

Press **MENU** button to display the main menu.

Press **◀/▶** button select **Lock system** in the main menu, then press **ENTER / ▼** to enter.



1. Press **▼ / ▲** button to select the option that you want to adjust in the **PARENTAL** menu.
2. Press **Enter/◀/▶** button to adjust.
3. After finishing your adjustment, press **MENU** button to save and return back to the previous menu. Default password is 0000, and if forget what you set, please call the service center.

Enable

Press **▼/▲** button to select Enable, then press **◀/▶** button to select On or Off.

Channel Locks, Parental Rating and Lock Keypad are available when Enable is **On**.

Channal Locks

Press **▼ / ▲** button to select Channal Locks, then press **Enter / ▶** button to enter sub-menu.



Parental Rating

Press **▼/▲** button to select Parental Rating, then press **◀/▶** button to select.

Lock Keypad

Set to prevent it from being used by young children, or other unexpected usage.

Press **▼ / ▲** button to select Lock Keypad, then press **◀/▶** button to select On or Off.

New Password

Press **▼ / ▲** button to select New Password, then enter a 4-digital number you want to set twice.

Reset

Press **▼ / ▲** button to select Reset, then press **Enter / ▶** button to enter Auto scan.

Main Menu Operation

6.5 Setup Menu

Press **MENU** button to display the main menu.

Press ◀/▶ button select **SETUP** in the main menu, then press **ENTER** / ▼ to enter.

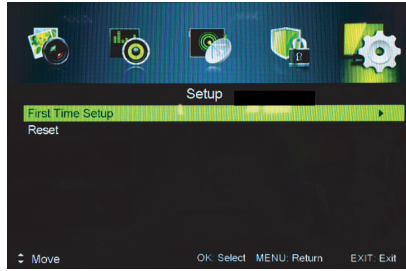
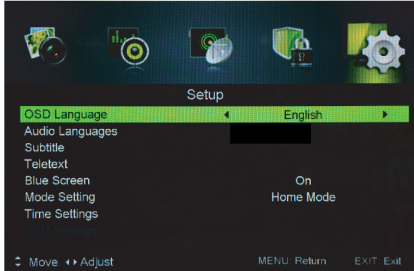

1. Press ▼/▲ button to select the option that you want to adjust in the **SETUP** menu.
2. Press **Enter**/◀/▶ button to adjust.
3. After finishing your adjustment, press **MENU** button to save and return back to the previous menu.

OSD Language

Press ▼/▲ button to select OSD Language, then press ◀/▶ button to select.

Audio Languages

Press ▼/▲ button to select Audio Languages, then press **Enter** button to enter sub-menu.

Press ▼/▲/◀/▶ button to select the Audio Primary Language and Audio Secondary Language.

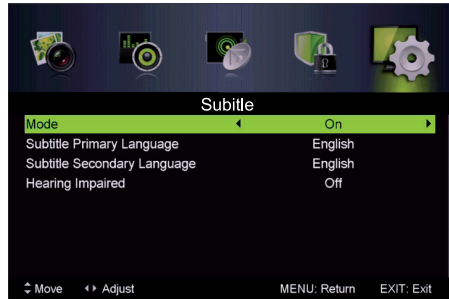

Subtitle

Press ▼/▲ button to select Subtitle, then press **Enter** button to enter sub-menu.

Mode

Press ▼/▲ button to select **Mode**, then press ◀/▶ button to select On or Off.

Press ▼/▲/◀/▶ button to select the Subtitle Primary Language and Subtitle Secondary Language.

Hearing Impaired

Press ▼/▲ button to select Hearing Impaired, then press ◀/▶ button to select On or Off.

Main Menu Operation

Teletext

Adjust Teletext settings. Only available under DTV and ATV source.

Press **▼ / ▲** button to select Teletext, then press **Enter / ►** button to enter sub-menu.

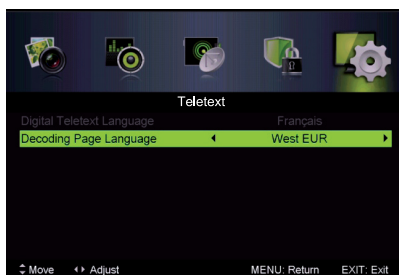
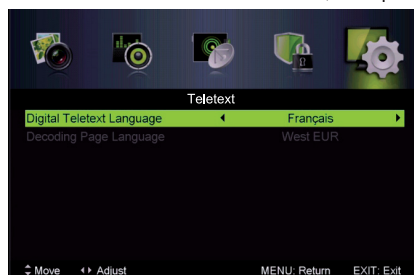

Under DTV source, press **◀ / ▶** button to select Digital Teletext Language.

Under ATV source, press **◀ / ▶** button to select Decoding Page Language.

Mode Setting

Press **▼ / ▲** button to select Mode Setting.

For normal use, select **Home**, for presentation at a store, select **Store**.

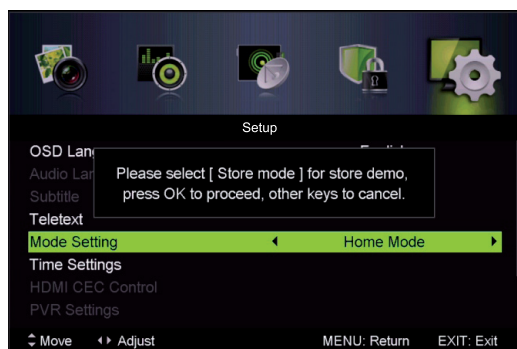

Time Settings

Press **▼ / ▲** button to select Time Settings, then press **Enter / ►** button to enter sub-menu.

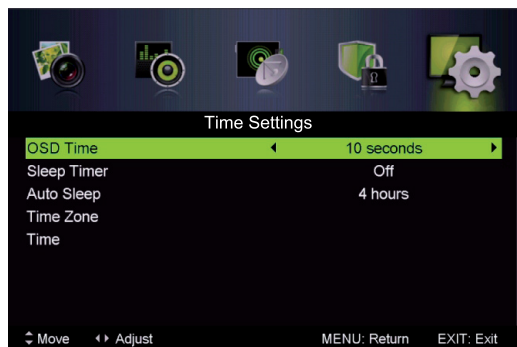

Main Menu Operation

OSD Time

Press ▼ / ▲ button to select OSD Time, press ◀ / ▶ button to select.
(Available OSD Time: Off, 10 seconds, 20 seconds, 30 seconds, 60 seconds).

Sleep Timer

Set a timer for the TV to turn off automatically.
Press ▼ / ▲ button to select Sleep Timer, press ◀ / ▶ button to select.
(Available Sleep Timer: Off, 5 mins, 15 mins, 30 mins, 60 mins, 90 mins, 120 mins, 240 mins).

Auto Sleep

Press ▼ / ▲ button to select Auto Sleep, press ◀ / ▶ button to select Off, 3 hours, 4 hours or 5 hours.

Time Zone

Select your time zone.
Press ▼ / ▲ button to select Time Zone, then press **Enter** / ▶ button to enter sub-menu.

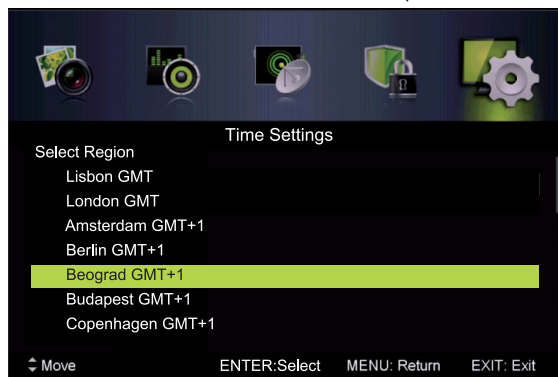

Time

Press ▼ / ▲ button to select Time, then press **Enter** / ▶ button to enter sub-menu.

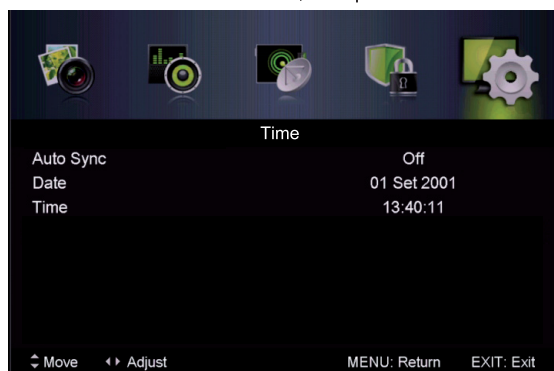

Set Auto Sync to Off, Power On/Off Timer to On, then you can set the time manually.

Note: In the case of loss of power, the clock setting will be lost.

PVR Settings

Press **▼** / **▲** button to select PVR Settings, then press **Enter** button to enter sub-menu. It will check the USB.



First Time Setup

Press **▼** / **▲** button to select First time Setup, then press **Enter** button to enter.

Auto Download

Press **▼** / **▲** button to select Auto Download, then press **◀** / **▶** button to select On or Off.

Reset

Press **▼** / **▲** button to select Reset, then press **Enter** button to enter sub-menu.

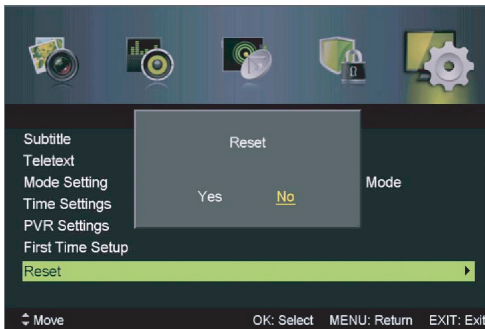

If you are sure to reset, press **Yes** to reset.

EPG Menu

Press the button EPG in the remote control to enter EPG menu.

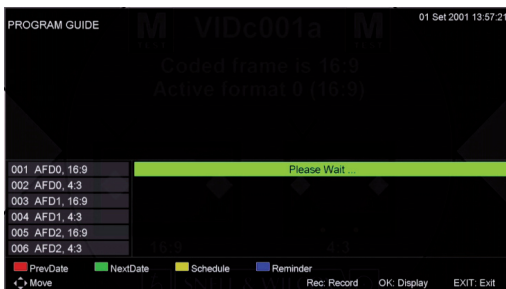

Note:

Broadcaster of the channel is responsible for EPG information.

6.6. PC Setting Menu

Press **INPUT** button on the remote control to select PC.

Press **MENU** button on the remote control to display the main menu.

Press **◀/▶** button on the remote control to select **PC SETTING** in the main menu.

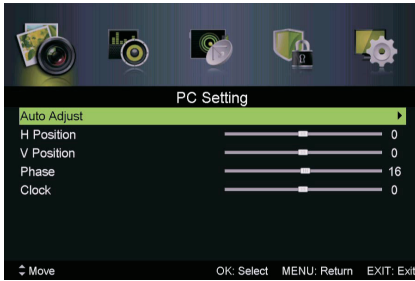

1. Press **▼/▲** button on the remote control to select the option that you want to adjust in the **PC SETTING** menu.
2. Press **ENTER** button on the remote control to adjust.
3. After finishing your adjustment, press **MENU** button to return back to the previous menu.

Auto Adjust

Press **ENTER/▶** button to adjust the screen automatically to the optimal position of the picture.

H Position

Adjust the horizontal position of the picture.

V Position

Adjust the vertical position of the picture.

Phase

Adjust the horizontal interfering lines.

Clock

Adjust the vertical interfering lines.

Notes:

1. Sharpness, Saturation and Advanced Setting in PICTURE menu are invalid.
2. Audio Description and Sound Type in SOUND menu are invalid.
3. Channel locks and Parental Rating in LOCK menu are invalid.
4. Audio Languages, Subtitles, Teletext and PVR Setting in SETUP menu are invalid.
5. PC mode has no CHANNEL menu.

ATV / SCART / HDMI / AV / YPbPr

1. **Screen Mode** in the **Picture** menu is only available in the **HDMI Input** mode.
2. **Audio Description** and **Sound Type** are not valid in the **Audio** menu.
3. The **SCART, HDMI, AV / YPbPr** modes do not support the **Channel** menu.
4. **Parental Rating** a **Channel Locks** in the **Lock** menu are not available for the **SCART, HDMI, AV / YPbPr** modes. **Parental Rating** is not available for the **ATV** mode.
5. **Audio Language** , **Subtitle** and **PVR Setting** in the **Setup** menu are not available for the **SCART, AV** modes. **Audio Language, Subtitle, Teletext** and **PVR Setting** in the **Setup** menu are not available for the **HDMI / YPbPr** mode.

7. USB Operation

Note: Before operating **USB** menu, Plug in USB device, then press **INPUT** button to set the Input Source to **USB**.

Press ◀/▶ button to select **USB** in the Source menu, then press **Enter** button to enter.

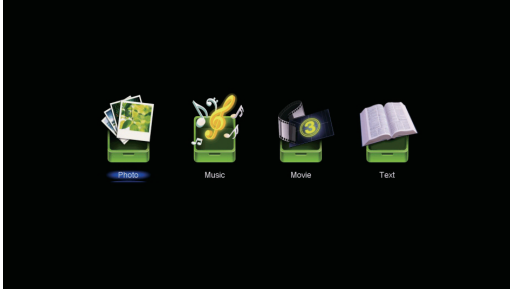

Press ◀/▶ button to select the option you want to adjust in the main **USB** menu, then press **Enter** button to enter.

7.1 Photo

Press ◀/▶ button to select PHOTO in the main menu, then press **Enter** button to enter.

Press ◀/▶ button to select drive disk you want to watch, then press **Enter** button to enter.

Press ◀/▶ button to select return option to back to the previous menu.

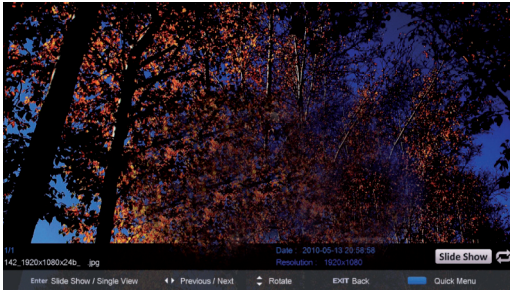

7.2 Music

Press ◀/▶ button to select MUSIC in the main menu, then press **Enter** button to enter.

Press ▼/▲ button to select drive disk you want to watch, then press **Enter** button to enter.

Press ▼/▲ button to select return option to back to the previous menu.

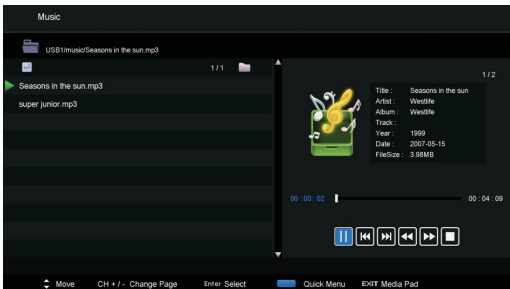

When highlighting the option you select, the file information will appear on the right.

7.3 Movie

Press ◀/▶ button to select MOVIE in the main menu, then press **Enter** button to enter.
 Press ▼/▲ button to select drive disk you want to watch, then press **Enter** button to enter.
 Press ▼/▲ button to select return option to back to the previous menu.

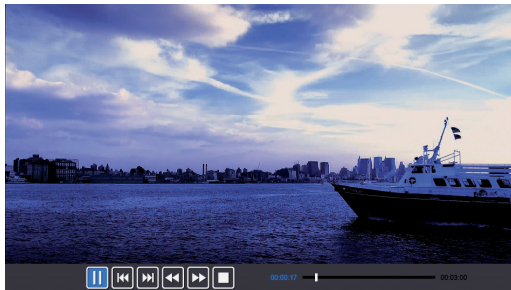

7.4 Text

Press ◀/▶ button to select TEXT in the main menu, then press **Enter** button to enter.
 Press ▼/▲ button to select drive disk you want to watch, then press **Enter** button to enter.
 Press ◀/▶ button to select return option to back to the previous menu.

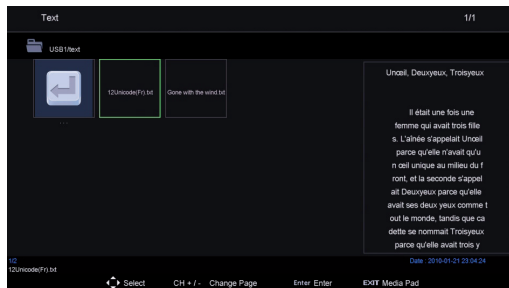

When highlighting the option you select, the file information will appear on the right.

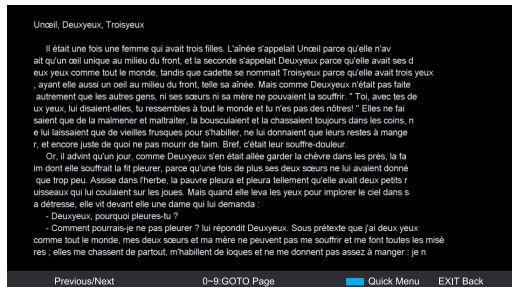

Troubleshooting guide

8. Troubleshooting guide

Troubleshooting

Before you contact our service, perform the following simple checks. If problem still persists, disconnect the TV and contact the service.

PROBLEM	POSSIBLE SOLUTION
No sound and picture	<ul style="list-style-type: none"> - Check whether the power cord is inserted the power outlet. - Check whether you have pressed the POWER button on the front panel of TV set. - Check the setting of brightness and contrast.
Normal picture, but no sound	<ul style="list-style-type: none"> - Check the volume. - Sound muted? Press MUTE button. - Try another channel, problem can be with broadcasting. - Are audio cable installed correctly?
The remote control does not work.	<ul style="list-style-type: none"> - Check whether there is no object between the TV and the remote control. - Are batteries inserted correctly? - Correct operating mode set: TV, VCR etc.? - Insert new batteries.
TV is suddenly turned off.	<ul style="list-style-type: none"> - Is sleep timer set? - Check the power supply. Power has been interrupted. - Auto turn off function has been activated and tuned channel broadcasts no signal, or the remote control has not been used for a long time.
Picture appears slowly after switching on.	<ul style="list-style-type: none"> - It is normal; the picture is muted during the startup process. If the picture does not appear after 5 minutes, please contact the service center.
No or poor color or poor picture	<ul style="list-style-type: none"> - Adjust the color in menu. - Keep a sufficient distance between the TV and the VCR. - Try another channel, problem can be with broadcasting. - Are the video cables installed correctly? - Activate any function to restore the picture brightness.
Horizontal/vertical bars or picture shaking.	<ul style="list-style-type: none"> - Check for local interference such as an electrical appliance.
Poor reception of some channels	<ul style="list-style-type: none"> - Channel or cable TV problems. Tune other station or frequency of the same channel. - Channel signal is poor or disturbed. Reorient the antenna or have the antenna checked. (Bad antenna is usually the most common cause of reception problems.) - Check for the source of possible interference.
Lines or streaks in picture	<ul style="list-style-type: none"> - Check the antenna (change the direction of the antenna).
No output form one of the speaker	<ul style="list-style-type: none"> - Adjust the balance in the menu.

Note:

Problem in VGA mode (only for VGA mode).

Troubleshooting guide

PROBLEM	POSSIBLE SOLUTION
The signal is out of range.	<ul style="list-style-type: none"> - Adjust resolution, horizontal frequency or vertical frequency. - Check whether the signal cable is not loose. - Check the input source.
Vertical bar or stripe on the background and horizontal noise and incorrect position.	<ul style="list-style-type: none"> - Start up the automatic setting or adjust timing, phase or H/V position.
Unstable colors or single color picture.	<ul style="list-style-type: none"> - Check the signal cable. - Reinstall the PC video card.

Maintenance

Suitable maintenance can prevent from untimely aging of the device. Regular and careful cleaning can prolong the lifetime of your TV set. Always turn off and unplug the device from the power outlet before cleaning.

Cleaning the screen

1. Wet the soft cloth in a mixture of lukewarm water and fabric softener or dish washing detergent. Wring the cloth until it is almost dry and then wipe the screen.
2. Be sure no water remain on the screen. Before turning on the device make sure the device is absolutely dry.

Cleaning the cabinet

To remove the dirt and dust use a dry and soft cloth. Do not use wet cloth.

Extended absence



If you do not use the TV for a long time (e. g. holiday), unplug the power cord to protect the device from possible damage from lightning or power surges.

Technical specifications

9. Technical specifications

Model	SLE 43F11M4	SLE 48F11M4
Panel size	43"	48"
Consumption	75 W	108 W
Standby power consumption	<0.5W	<0.5W
Nominal voltage	110 - 240 V /50~ 60 Hz	110 - 240 V /50~ 60 Hz
Remote control	Yes, 2x AAA batteries	Yes, 2x AAA batteries
VESA wall mount	VESA 200	VESA 200
Dimensions with stand (W x H x D)	975 x 241 x 617 mm	1088 x 231 x 682 mm
Dimensions w/o stand (W x H x D)	975 x 80 x 571 mm	1088 x 80 x 636 mm
Dimensions of package (W x H x D)	1108 x 650 x 160 mm	1108 x 650 x 160 mm
Weight netto with stand	7.84 kg	10.25 kg
Weight netto w/o stand	7.62 kg	10.01 kg
Connections		
RF IN	1	1
AV in	1	1
SCART	1	1
Component YPbPr	1	1
VGA (D-Sub 15 pin)	1	1
HDMI	3	3
SPDIF coaxial	1	1
USB	1	1
USB supported formats	AVI, MPEG, MPEG-4, TS, MKV, FLV, VC-1/WMV9, AAC, WAV, JPG, JPEG, TXT, RMVB, MP3	AVI, MPEG, MPEG-4, TS, MKV, FLV, VC-1/WMV9, AAC, WAV, JPG, JPEG, TXT, RMVB, MP3
CI+ slot	1	1
Other features		
WXGA resolution	1920 X 1080	1920 X 1080
Brightness (cd/m2)	600	600
Aspect ratio	16:9	16:9
Dynamic contrast	1 000 000:1	1 000 000:1
Response time (ms)	6ms	6ms
Colours	16.7mil	16.7mil
Colour temperature settings	cool, standard, warm	cool, standard, warm
Viewing angle	178/178	178/178
Built-in tuner	HD DVB-T/C CI+	HD DVB-T/C CI+
Video system	PAL/AV NTSC/SECAM	PAL/AV NTSC/SECAM
Audio system	BG/DK/I(PAL),BG/DK(SECAM)	BG/DK/I(PAL),BG/DK(SECAM)
Stereo sound	NICAM/A2	NICAM/A2
Sound output	2 x 8 W	2 x 8 W
PVR recording to USB	Yes	Yes
Pitch correction	Yes	Yes
Progressive Scan	Yes	Yes
Timeshift function	Yes	Yes
Electronic Programme Guide EPG	Yes	Yes
Teletext	Yes	Yes
Teletext pages	1000	1000
Comb filter	3d	3d
OSD menu	Yes	Yes
Zoom	Yes	Yes
Noise reduction	Yes	Yes
Timer off /on/sleep	Yes	Yes
Subtitles	Yes	Yes
Audio language	Yes	Yes
Channel list	Yes	Yes
Favourites list	Yes	Yes
Picture freeze	Yes	Yes
Radio	Yes	Yes
Lock	Yes	Yes
Parent lock	Yes	Yes
Hotel mode	Yes	Yes

Features and specifications are subject to change without notice.

INSTRUCTIONS AND INFORMATION REGARDING THE DISPOSAL OF USED PACKAGING MATERIALS

Dispose of packaging material at a public waste disposal site.

DISPOSAL OF USED ELECTRICAL AND ELECTRONIC APPLIANCES



The meaning of the symbol on the product, its accessory or packaging indicates that this product shall not be treated as household waste. Please, dispose of this product at your applicable collection point for the recycling of electrical & electronic equipment waste. Alternatively in some states of the European Union or other European states you may return your products to your local retailer when buying an equivalent new product. The correct disposal of this product will help save valuable natural resources and help in preventing the potential negative impact on the environment and human health, which could be caused as a result of improper liquidation of waste. Please ask your local authorities or the nearest waste collection centre for further details. The improper disposal of this type of waste may fall subject to national regulations for fines.

For business entities in the European Union

If you wish to dispose of an electrical or electronic device, request the necessary information from your seller or supplier.

Disposal in other countries outside the European Union

If you wish to dispose of this product, request the necessary information about the correct disposal method from local government departments or from your seller.



This product meets all the basic EU regulation requirements that relate to it.

Changes to the text, design and technical specifications may occur without prior notice and we reserve the right to make these changes.

SENCOR®

EN Warranty conditions

Warranty card is not a part of the device packaging.

This product is warranted for the period of 24 months from the date of purchase to the end-user. Warranty is limited to the following conditions. Warranty is referred only to the customer goods using for common domestic use. The claim for service can be applied either at dealer's shop where the product was bought, or at below mentioned authorized service shops. The end-user is obligated to set up a claim immediately when the defects appeared but only till the end of warranty period. The end user is obligated to cooperate to certify the claiming defects. Only completed and clean (according to hygienic standards) product will be accepted. In case of eligible warranty claim the warranty period will be prolonged by the period from the date of claim application till the date of taking over the product by end-user, or the date the end-user is obligated to take it over. To obtain the service under this warranty, end-user is obligated to certify his claim with duly completed following documents: receipt, certificate of warranty, certificate of installation.

This warranty is void especially if apply as follows:

- Defects which were put on sale.
- Wear-out or damage caused by common use.
- The product was damaged by unprofessional or wrong installation, used in contrary to the applicable instruction manual, used in contrary to legal enactment and common process of use or used for another purpose which has been designed for.
- The product was damaged by uncared-for or insufficient maintenance.
- The product was damaged by dirt, accident of force majeure (natural disaster, fire, and flood).
- Defects on functionality caused by low duality of signal, electromagnetic field interference etc.
- The product was mechanically damaged (e.g. broken button, fall).
- Damage caused by use of unsuitable media, fillings, expendable supplies (batteries) or by unsuitable working conditions (e.g. high temperatures, high humidity, quakes).
- Repair, modification or other failure action to the product by unauthorized person.
- End-user did not prove enough his right to claim (time and place of purchase).
- Data on presented documents differs from data on products.
- Cases when the claiming product cannot be indentified according to the presented documents (e.g. the serial number or the warranty seal has been damaged).

Authorized service centers

Visit www.sencor.eu for detailed information about authorized service centers.