

SENCOR®

SLE 40F11

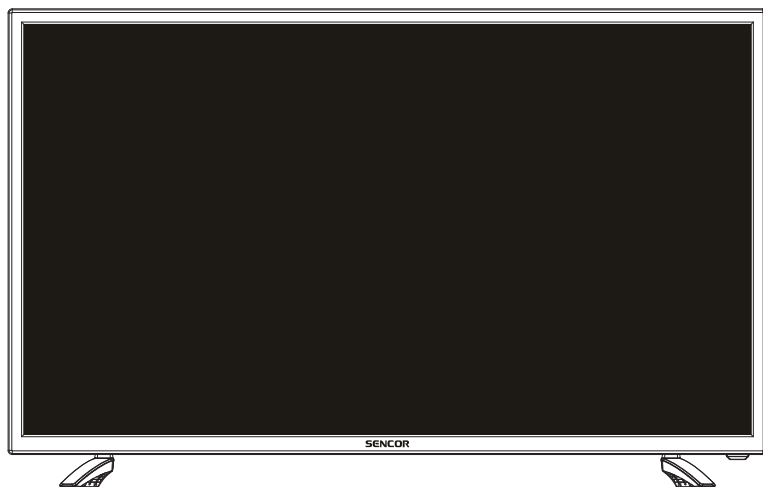



LED Television User's Manual

Carefully read this user's manual before putting the television into operation. Keep it for future use. Record the model number and the serial number of the television. See the label on the rear cover and provide this information to your vendor in the event that you require repairs.

Important safety measures	3
1. Description of the appliance	8
2. Remote control	9
3. Connecting and setting up	11
4. Selecting an input source	13
5. Initial setup	14
6. Using the menus	15
6.1 Picture (Picture) menu	15
6.2 Sound (Sound) menu	17
6.3 Channel (Channel) menu	19
6.4 Lock (Lock) menu	23
6.5 Setup menu (Setup)	24
7. USB control	30
7.1 Photo (Photos)	30
7.2 Music (Music)	30
7.3 Movie (Movie)	31
7.4 Text (Text)	31
8. Troubleshooting guide	32
9. Technical specifications	34
10. Information sheet	35

Important safety measures

If you want to use this product correctly, carefully read this user's manual and store it for future reference. If you give (sell) the appliance to somebody, please also include all the documentation together with this appliance, including this user's manual.

	<p>The flash symbol in an equilateral triangle indicates that there is dangerous voltage inside this appliance, which presents a risk of injury by electrical shock.</p>
	<p>The exclamation mark in an equilateral triangle symbol indicates important operating or servicing instructions in the appliance's documentation.</p>
<p>To reduce the risk of injury by electrical shock do not remove the cover (or the rear side). There are no components inside which the user can repair. Have all repairs or adjustments performed at an authorised service centre.</p>	

GENERAL SAFETY INSTRUCTIONS

- Carefully read this manual before using the appliance. Follow the instructions contained in this user's manual.
- Heed all warnings.
- Adhere to all instructions.
- Use only accessories determined by the manufacturer.
- **AN OPEN FLAME MUST NOT BE PLACED ON THE APPLIANCE, E.G. A BURNING CANDLE. DO NOT PLACE HOT ITEMS OR OBJECTS WITH AN OPEN FLAME E.G. CANDLES OR NIGHT LAMPS ON OR IN THE VICINITY OF THE APPLIANCE. HIGH TEMPERATURES MAY MELT PLASTIC PARTS AND CAUSE A FIRE.**
- Use the appliance in a temperate climate zone.
- Under no condition does the manufacturer or the vendor of the appliance take responsibility for any direct or indirect damages caused by not adhering to instructions for installation, setup, use, service or cleaning of this appliance as described in this user's manual.
- Protect the appliance against being knocked, dropped, hit and shaken and against vibrations, humidity and dust.
- Before allowing children to use the appliance, they must be appropriately to their age, informed about the correct and safe use of the player.
- If the appliance is equipped with a headphone jack, do not use headphones set to an extreme volume. There is a danger of hearing damage or loss.

Installation, operation

- Install the appliance according to the instructions in the user's manual.
- Leave free space on all sides of the appliance necessary for proper air circulation. This removes the heat created during operation. Covering the ventilation openings of the appliance's case creates a risk of overheating or damaging the appliance. It is necessary to ensure that the ventilation openings are not blocked, e.g. by a newspaper, table cloth, curtain, etc. Follow the installation instructions in the user's manual.
- This appliance should not be located in a confined area such as a bookshelf or rack, if sufficient ventilation is not provided for or the instructions of the manufacturer are not followed.
- Never insert any items into any ventilation or other openings because they could come into contact with points with dangerous voltage levels or cause a short circuit of parts, which could cause a fire or injury by electric shock. Never pour any liquid into the appliance.
- Do not install the appliance in direct sunlight or near sources of heat, such as heaters, heat exchangers, stoves or other appliances (including amplifiers) producing heat. High temperatures significantly reduce the lifetime of electronic components in the appliance. Do not use or leave the appliance in the vicinity of an open fire.

Important safety measures

- The appliance must not be exposed to dripping or running water and objects filled with water must not be placed on it, e.g. vases. Protect the appliance against rain, spray or contact with any other liquid, do not leave or install the appliance outdoors. Do not use the appliance outdoors. Not adhering to these instructions creates a risk of electrical shock or fire hazard.
- Do not use this appliance near water.
- Treat the glass panel and appliance cover with care. The screen glass can break on impact and cause serious injuries.
- Make sure that the power cord is not stepped on or compressed, particularly near the power plug, power socket and at the point where it exits the appliance or the adapter. The power plug (adapter) is used as a disconnection device and must be easily accessible.
- Never use a appliance with a damaged power cord or plug. If the power cord or plug are damaged, turn off the appliance, disconnect it from the power source and contact an authorised service centre. A damaged power cord or plug may only be replaced by qualified personnel. Under no circumstances attempt to replace the power cord or plug yourself.
- Do not attempt to circumvent the polarised power plug safety feature. If the power plug cannot be inserted into your power socket, contact a qualified electrician to replace the old type of power socket.
- Before connecting the appliance into a power socket, check that the voltage in your power socket corresponds to the voltage on the rating label of the appliance or on its power adapter. If you are not certain about the type of the power sources in your home, contact your vendor or the local energy company.
- Before turning on the appliance, check that the electrical connection is performed properly and in accordance with the instructions of the manufacturer. Before connecting or changing the connection, turn off the appliance and disconnect it from the mains.
- Remember to always disconnect the power plug (adapter) from the power socket before disconnecting the power cable from the rear side of the appliance.
- Insert the power plug into a independent power socket. Do not overload wall sockets with extension cords or multi-socket adapters. There is a risk of injury by electric shock.
- When disconnecting, hold the power cord by the plug and not by the cord itself.
- Disconnect the appliance from the power socket during storms or if you will not be using it for a longer time.
- Avoid moving the appliance from a cold environment to a warm one or vice versa, or when using the appliance in a very humid environment. Air humidity may condense on some components inside the case of the appliance and the appliance may stop working temporarily. If this occurs leave the appliance in a warm and well ventilated place and wait 1 – 2 hours until the moisture evaporates and the appliance can once more be used as usual. Take care especially during the first use of the player immediately after its purchase during a cold season.
- Do not place this appliance on an unstable cart, pedestal, stand, bracket or table. The appliance could fall and cause serious injuries to children or adults or could be seriously damaged or damage other items. Only use the appliance with a cart, pedestal, stand or table designated by the manufacturer or sold with the appliance. Any mounting of the appliance should be carried out according to the manufacturer's instructions and the mounting accessories recommended by the manufacturer should be used.
- Do not lean on the appliance, do not lean over it or use it as a step. Protect it against violent movements. Ensure that children do not play with the appliance.



If using the cart, be careful when moving it. Stopping suddenly, excessive force and uneven surfaces could cause the cart to fall over with the appliance.

- Neither the manufacturer nor the vendor of the appliance under any condition takes responsibility for any direct or indirect damages caused by not adhering to the instructions for installation, setup, use, service or cleaning of this appliance as described in this user's manual.
- Protect the appliance against being knocked, dropped, hit and shaken and against vibrations, humidity and dust.
- Do not expose the appliance to extreme temperatures or humid conditions.

Note:

If the appliance is powered by an adapter, use only the adapter and AC power cord supplied with the appliance. Do not use faulty power sockets. Check that the power plug is properly inserted into the power socket. If the power plug is loose, arcing could result in a fire. Contact a qualified electrician to have your socket replaced.

Note:

Only connect the appliance to a properly grounded socket with a protective grounding pin.

Note:

If you will be installing the appliance on a wall or to the ceiling, follow the manufacturer's instruction found in the user's manual of the particular appliance.

Repairs and maintenance

- To prevent risk of injury through electric shock or the creation of a fire, do not take the appliance out of the case - there are no parts inside the case repairable or adjustable by the user without appropriate equipment and qualifications. Should the appliance require adjustment or repair, contact a professional service centre.
- In the case of any unusual events occurring during the use of the appliance, e.g. if there is a distinct smell of burning insulation or smoke comes out of the appliance, immediately turn off the appliance, disconnect the appliance from the power source and do not use the appliance until you have received the results of an inspection by the employees of the professional service centre.
- Have all repairs carried out by qualified personnel. Repairs are necessary if the appliance has been damaged in any way, for example if the power cord is damaged, liquid was poured on the appliance, foreign objects have entered the appliance, the appliance has been exposed to rain or moisture, if the appliance is not working as usual or if it has fallen.
- In the event of repair or replacement of a part of the appliance, ensure that the service technician uses components designated by the manufacturer or that these components have the same specifications as the original ones. Unauthorised replacements could cause a fire, lead to a danger of injury by electrical shock or other dangers.
- Before cleaning, carrying or other maintenance, disconnect the plug (adapter) from the power socket.
- Clean the appliance only with a dry cloth.
- For cleaning do not use petrol, thinners or any other solvents or use any abrasive cleaning agents, steel wool or any sponges with steel wool.

Note:

Do not throw the appliance into ordinary household waste. For disposal follow all local laws and regulations.

Remote control and batteries

- Do not expose the remote control or the batteries to direct sunlight or sources of heat, such as heaters, heat exchangers, stoves or other appliances (including amplifiers) that produce heat. Do not use or leave the appliance in the vicinity of an open fire.
- Ensure that the sensor is not exposed to a strong light source (e.g. sunlight) or light from fluorescent light tubes, which could reduce the effectiveness and reliability of the remote control.
- Neither the remote control nor the batteries may be exposed to dripping or running water and objects filled with water must not be placed on them, e.g. vases. Protect against exposure to rain, spraying or pouring of any kind of liquid. Do not use outdoors. Not following these instructions creates a danger of damage to the remote control or to the battery.
- Do not use this appliance near water.
- It is necessary to pay attention to the environmental impact aspects of battery disposal.

Important safety measures

- The incorrect use of batteries may cause the leakage of the electrolyte and corrosion. To ensure that the remote control works correctly, proceed according to the instructions below:
 - Do not insert the batteries in the wrong polarity orientation.
 - Do not charge, heat, open or short circuit the batteries.
 - Do not throw batteries into a fire.
 - Do not leave discharged batteries in the remote control.
 - Do not combine various types of batteries or new and old batteries.
 - If you will not be using the remote control for a longer period of time, remove the batteries to prevent potential damage caused by a subsequent battery leakage.
 - If the remote control is not working correctly or its operational range is reduced, change all batteries for new ones.
 - If electrolyte leaks out from the batteries, have the remote control cleaned by an authorised service centre.

Attention: To prevent a fire hazard or injury by electrical shock, do not expose this appliance to rain or humidity.

Attention: Batteries must not be exposed to excessive heat, for example sunlight, fire, etc.



This symbol indicates that the appliance has double insulation between the dangerous mains voltage and the parts accessible to the user. In the event of repairs use only identical spare parts.

SENCOR[®] Supplement to the LCD TV user's manual

Measures to take when a static image is displayed; red/blue/green pixels on the screen

A static image can permanently damage the display part of the television

- Do not leave a static image on an LCD screen for longer than 2 hours, because this could damage the screen. This type of damage is known as "screen burn-in".
- Similar damage to the LCD screen can be caused by a statically located TV channel logo.
- Watching television in 4:3, 16:9 formats or similar (formats not covering the entire area of the screen) for a long time may leave marks on the right or left side, or possibly in the middle of the picture as a result of the differences in light emission. Similar damage may also occur when watching a DVD or playing games.
- The display of a static image from video games or computers for an extended period of time may cause a partial effect of a "persistent image". To prevent this effect from occurring, lower the brightness and contrast when displaying a static picture.



Damage to the screen resulting from the above mentioned causes is not covered by the warranty!

Red/blue/green/black pixels may appear on the screen

- This is a characteristic feature of liquid crystal displays and does not represent a problem. LCD screens are manufactured using a very precise technology in order to achieve a very fine picture resolution. From time to time several inactive pixels may appear on the screen as a permanently red, blue, green or black pixel (up to 0.001% of the total number of pixels on the screen). This does not in any way affect the features and performance of your television.

Notes on the USB connector:

USB memory devices must be inserted into the appliance directly. To prevent data transmission failure or its interference, do not use USB extension cables. Electrostatic discharges may cause the appliance to malfunction. In such an event the user must restart the appliance.

Before using a USB flash drive test its ability to communicate with the appliance and its data reading and writing speed.

To achieve maximum reading speed we recommend that you keep disk space defragmented. Use the FAT32 file system, a single partition, without protection. If reading and writing on the USB memory device is not continuous, undesirable effects may occur such as partial image loss (distortions/ checkering effects) or complete image loss, audio defects, and in extreme cases the operation will be stopped. Unexpected behaviour of the connected memory device, or the presence of viruses or other damaging software may cause the functions of the appliance to stop working, necessitating a restart.

The USB connector is the standard type and is not able to power a USB device with a high power usage (e.g. hard disk drives HDD). Use devices with independent power supplies and power them from their own power supplies.

The appliance was designed to achieve maximum compatibility with memory devices. With respect to the variety of devices on the market it is not possible to guarantee compatibility with every USB device. In the event of difficulties try formatting the flash drive directly in the appliance. If problems persist, use a different flash drive.

Due to the wide range of USB devices available on the market it is not possible to guarantee the compatibility of the appliance with all USB devices.

Serial number of the appliance

The serial number of the appliance is unique and unequivocally identifies your appliance. Enter the serial number of your appliance together with other details necessary for the definite identification of your appliance below.

Serial number: _____

Date of purchase: _____

Description of the appliance

1. Description of the appliance

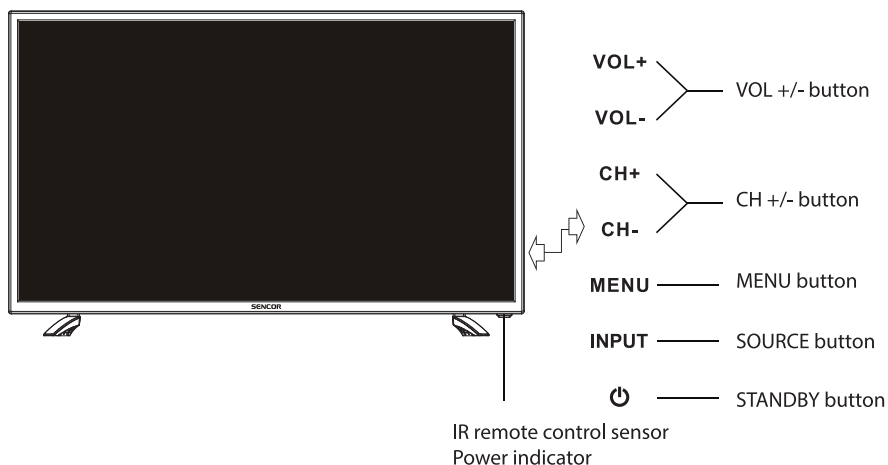

STANDBY button

Turns the television on from the stand-by mode.

VOL +/- button

Press to increase/decrease the volume. In the OSD menu it serves as the left/right arrows.

CH +/- button

Press to switch between individual channels. In the OSD menu it serves as the up/down arrows.

MENU button

In TV mode it displays the LCD television's main menu.

SOURCE button

Press to select the desired input.

IR remote control sensor

Point the remote control at this sensor.

Power indicator

2. Remote control

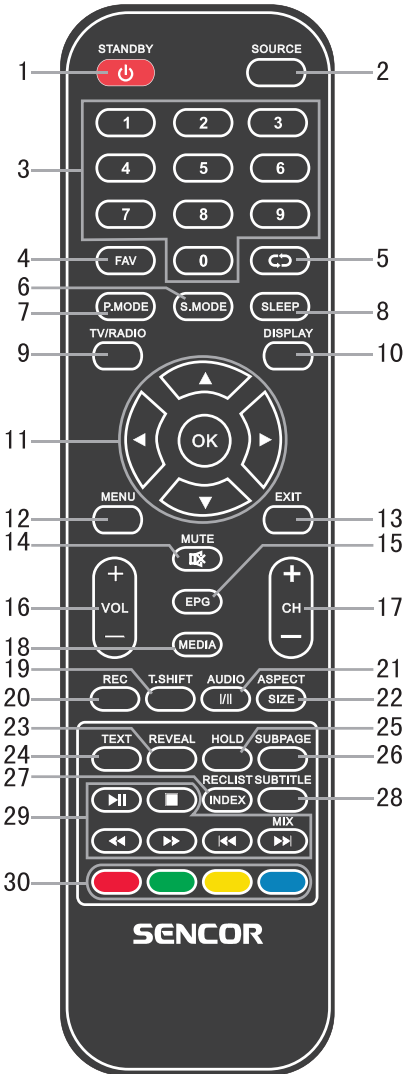

1. STANDBY button

Turns the television on from the stand-by mode.

2. SOURCE button

Press to select the desired input.

3. Numerical buttons 0-9

Press 0-9 to directly select a TV channel while watching the TV.

In teletext mode enter the page number, etc.

4. FAV button

Press in the TV mode to enter / exit the favourites menu.

5. \square button

Button for switching to the previously watched channel.

6. SMODE button

Repeatedly press to select a sound mode.

7. PMODE button

Repeatedly press to select a picture mode.

8. SLEEP button

Set the automatic shut off time for the television.

9. TV/RADIO button

Switching between the television and radio modes.

10. DISPLAY button

Button for displaying the source and information about channels.

11. $\uparrow/\downarrow/\leftarrow/\rightarrow$ /OK buttons

Used for navigating in a menu on the screen and for setting up the television according to your preferences.

12. MENU button

In TV mode it displays the LCD television's main menu.

13. EXIT button

Function for exiting a menu or a screen.

14. MUTE button

Press to mute the sound. Press it again to renew the sound or press VOL +.

15. EPG button

Press to show/hide the electronic program guide.

16. VOL +/- buttons

Press to increase/decrease the volume.

17. CH +/- buttons

Press to switch between individual channels.

18. MEDIA button

Press to switch to the Media (USB) mode.

19. T.SHIFT button

It is used to start recording with a time shift (i.e. time shift). Function is only available in the DTV mode.

20. REC button

Used to start recording (only in DTV mode).

21. AUDIO button

DTV/MEDIA mode: select a background sound, if available.

ATV mode: select a sound mode: Stereo/Dual I / II/Mono.

Other sources: select the left / right channel

22. SIZE button

Press SIZE to change the size of the screen in the MEDIA mode.

23. REVEAL button

Press REVEAL to display or hide hidden teletext information (depends on the broadcast).

24. TTX button

Turn teletext on or off.

Note: The teletext function is optional and the availability of buttons depends on the model. Teletext information fully depends on the operator of the channel.

25. HOLD button

Freezes the current picture.

26. SUBPAGE button

Press to enter a teletext subpage.

27. RECLIST button

Enter the list of recordings

28. SUBTITLE button

Button for showing / hiding subtitles in the bottom part of the screen, if they are available.

29. ►II/■/◀◀//►►/|◀◀/►►I/MIX buttons

►II: start / pause playback, start timeshift recording function.

■: Stop recording / playback.

◀◀: Fast rewind

►►: Fast forward

|◀◀: Skip to previous track

►►I: Skip to next track

MIX: TV picture and teletext content are simultaneously displayed on the screen.

30. RED, GREEN, YELLOW, BLUE button:

corresponds to various colour functions in the menu or teletext.

Note:

Remove the batteries if you will be storing the appliance or not using it for an extended period of time.

- To control the appliance using the remote control, point the remote control at the appliance and then press the button with the required function. The effective range of the remote control is up to about 5 meters with a maximum deviation of +/- 30° from the perpendicular direction to the reception sensor of the remote control on the front side of the appliance. The falling capacity of the batteries gradually reduces the remote control range. There must be no solid obstacles in the area between the remote control and the appliance when the remote control is being used.
- During standard use the lifetime of batteries in the remote control is about 1 year. When the effective range of the remote control is substantially reduced or when there are problems with its use, change both the batteries in the remote control. If you will not be using the remote control for a longer period of time, take out both batteries - in this way you will prevent potential damage caused by their leakage.
- Prevent strong light from falling on the appliance, (e.g. sunlight or strong fluorescent lamps or ecological light bulbs), which could reduce the effectiveness and reliability of the infrared remote control.

Connecting and setting up

Connecting and setting up

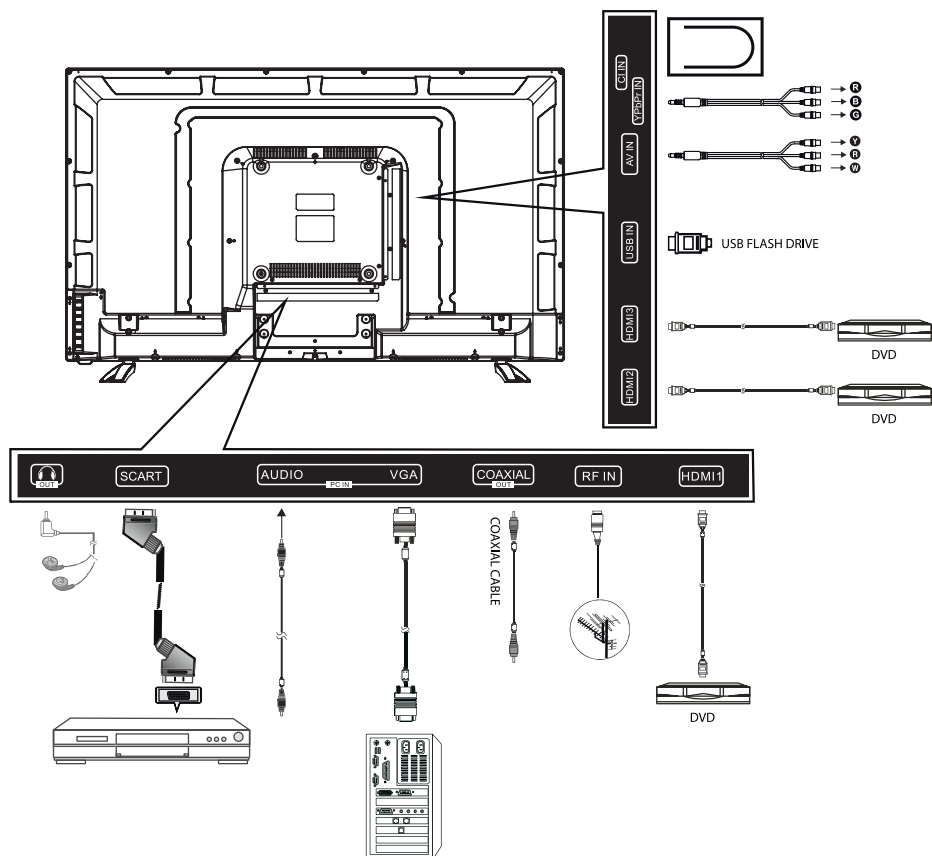

- Y** Video (yellow AV)
- R** Audio right (red AV)
- W** Audio left (white AV)
- G** Component Y (green)
- B** Component Pb (blue)
- R** Component Pr (red)

Installing cables

Please carefully read the entire user's manual before installation and operation.

1. Take the TV out of the packaging and place it on an even rigid surface.

Note:

Before connecting or disconnecting a TV, computer or other devices it is necessary to check that the power cord is disconnected. When disconnecting power or signal cables, hold the cable by the end, never pull on the cable itself.

2. An IEC antenna connector can be connected with the VF television input connector.
3. The AV output connector DVD can be connected with the television's AV output using an AV cable.
4. Connect one end of the VGA cable to the VGA port on the computer and the other end of the VGA cable to the VGA port on the television and on both ends tighten the screws in the clockwise direction.

Note:

When connecting the 15-pin VGA connector, do not use excessive force so as not to damage the individual pins.

5. Connect one end of the HDMI cable to the HDMI device and the other end of the HDMI cable to the TV.

Note:

When connecting HDMI cables ensure that the correct orientation is maintained and do not use excessive force so as not to damage the individual pins.

6. Check that all AV cables are correctly inserted into the corresponding ports.
7. To these connectors connect the input or output SCART connector of the external device.
8. Connect the power cord to a power socket with a voltage of 110 – 240 V ~.

Note:

The permitted power voltage range for this TV is 110 – 240 V~ 50/60 Hz. Do not connect the TV to a power source outside of this range.

When connecting and disconnecting the power cord, hold the plug by the insulated part and do not touch the metal parts of the plug.

Selecting an input source

4. Selecting an input source

Press the **SOURCE** button to show the input source list.

Use the ▲/▼ or **SOURCE** buttons to select the required input source.

Press the **OK** button to confirm the input source.

Press the **EXIT** button to exit the menu.

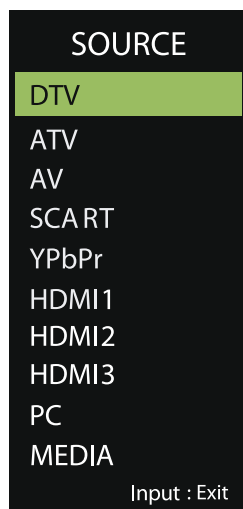

5. Initial setup

Use an antenna cable to connect the television (RF-IN input) with the antenna socket.

OSD Language (OSD language)

Use the ◀/▶ buttons to select a language for the menus and messages.

Mode Setting (Mode settings)

Use the ◀/▶ buttons to select a mode.

Country (Country)

Use the ◀/▶ buttons to select the country of installation.

Antenna Type (Antenna type)

Use the ◀/▶ buttons to select the antenna type.

Auto Scan (Automatic search)

Use the ◀/▶ buttons to select a mode: DTV + ATV, DTV or ATV.

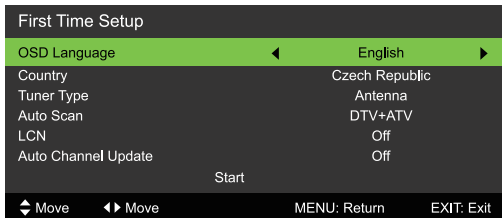

Auto Tuning Status (Auto tuning status)

The first tuning is digital. To leave out digital tuning, press the **MENU** button.

The second tuning is analogue. To leave out analogue tuning, press the **MENU** button.

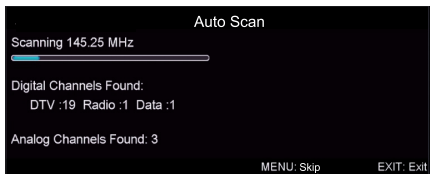
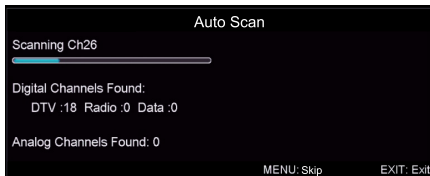

6. Using the menus

6.1 Picture (Picture) menu

Press **MENU** to show the main menu.

Use the ◀▶ buttons to select **Picture (Picture)** and enter the menu by pressing the **OK/▼** button.

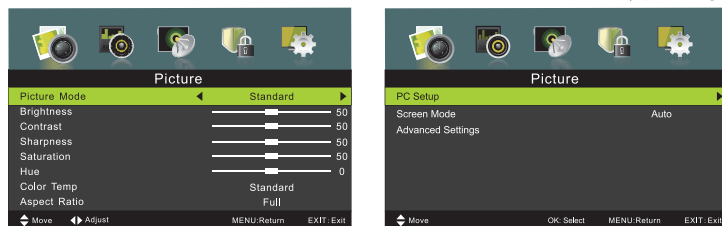

1. Press ▲▼ to select the desired item that you wish to modify.
2. Use the **OK/◀▶** button to make the settings.
3. After completing setup, press the **MENU** button to save and to return to the previous menu.

Picture Mode (Picture mode)

Use the ▲▼ buttons to select the item **Picture Mode (Picture mode)** and the ◀▶ buttons to select a mode. In the menu there are the following modes: **Standard (Standard)**, **Mild (Mild)**, **Personal (Personal)**, **Dynamic (Dynamic)**.

Brightness (Brightness) / Contrast (Contrast) / Sharpness (Sharpness) / Saturation (Saturation) / Hue (Hue)

Use the ▲▼ buttons to select an option and the ◀▶ buttons to perform the setting.

Brightness (Brightness)	Set the brightness of the entire picture.
Contrast (Contrast)	Set the picture contrast, nevertheless the hue of the picture will remain the same.
Sharpness (Sharpness)	Set the sharpness of the picture details.
Saturation (Saturation)	Set the colour saturation.
Hue (Hue)	Set the colour hue used in NTSC mode.

Color Temperature (Colour temperature)

Serves to change the colour spectrum of the picture.

Use the ▲▼ buttons to select the item **Color Temp (Colour temperature)** and change the settings using the ◀▶ buttons. In the menu there are the following modes: **Standard (Standard)** / **Cool (Cool)** / **Warm (Warm)**.

Standard (Standard)	The result is a vivid picture.
Cool (Cool)	The result is a slightly blueish hue of the picture.
Warm (Warm)	The result is a reddish hue of the picture.

Aspect Ratio (Side aspect ratio)

Use the ▲▼ buttons to select **Aspect Ratio (Side aspect ratio)** and the ◀▶ buttons to select the respective side aspect ratio.

Auto (Automatic) Automatic side aspect ratio setting depending on the size of the TV and the program that is being broadcast.

Full / 4:3 / Zoom 1 / Zoom 2 Select depending on the recommended format.

PC Setting (PC settings)

Press the **INPUT** button and select **PC**.

Press the **MENU** button to enter the main menu, then use the ◀▶ buttons to select **PICTURE (Picture)**. Press the **OK/▼** button to enter the menu and then use the ▼ button to select **PC Setting (PC Settings)**.

Using the menus

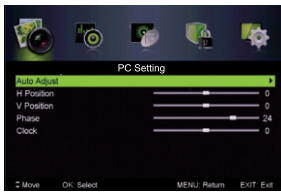

Use the ▼/▲ buttons to select an item and set the value using the ◀/▶ buttons.

- | | |
|---|---|
| Auto Adjust (Automatic adjustment) | Press the MENU/▶ button to automatically set the optimal picture position. |
| H position (H position) | Set the horizontal position of the picture |
| V position (V position) | Set the vertical position of the picture |
| Phase (Phase) | Minimum horizontal distortion |
| Clock (Clock) | Minimum vertical distortion |

Screen Mode (Screen mode)

Use the ▲/▼ buttons to select the **HDMI** mode, then use the ◀/▶ buttons to select **Auto (Automatic)**, **Video (Video)** or **PC (computer)**. These option are only available in the HDMI mode.

Advanced Settings (Advanced settings)

Perform advanced settings to fine tune the picture.

Use the ▲/▼ buttons to select **Advanced Settings (Advanced settings)** and the **OK /▶** button to enter the submenu.

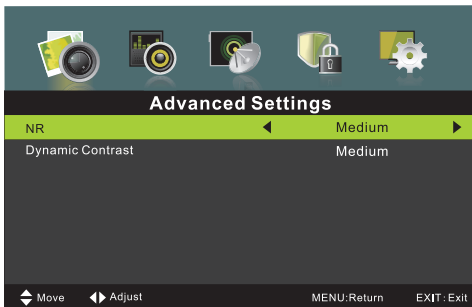

NR (Noise reduction)

Set the picture noise reduction option. Use the ▲/▼ buttons to select option NR and the ◀/▶ buttons to select the mode.

- | | |
|------------------------|--|
| Off (Off) | Noise reduction will be off. |
| Weak (Weak) | Detection and reduction of weak picture noise. |
| Medium (Medium) | Detection and reduction of medium picture noise. |
| Strong (Strong) | Detection and reduction of strong picture noise. |

Dynamic Contrast (Dynamic contrast)

Automatic picture detail and brightness settings Use the ▲/▼ buttons to select **Dynamic Contrast (Dynamic contrast)** and the ◀/▶ buttons to select the desired mode. The following option are available: **Off (Off)**, **Weak (Weak)**, **Medium (Medium)**, **Strong (Strong)**.

6.2 Sound (Sound) menu

Press **MENU** to show the main menu.

Use the **◀/▶** buttons to select **Audio (Audio)** and enter the menu by pressing the **OK/▼** button.

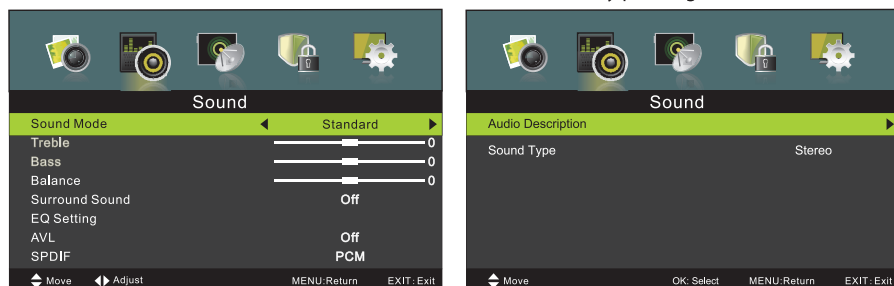

1. Press **▲/▼** to select the desired item that you wish to modify.
2. Use the **OK/◀/▶** button to make the settings.
3. After completing setup, press the **MENU** button to save and to return to the previous menu.

Sound Mode (Sound mode)

Use the **▲/▼** buttons to select **Sound Mode (Sound mode)** and use the **◀/▶** buttons to select an audio mode. The following option are available: **Standard (Standard)**, **Music (Music)**, **Personal (Personal)**, **Movie (Movie)**.

Treble (Treble) / Bass (Bass) / Balance (Balance)

Use the **▲/▼** buttons to select an item and the **◀/▶** buttons to make a setting.

- Treble (Treble)** Set the treble for the sound. Increase or decrease the high tones.
- Bass (Bass)** Set the bass for the sound. Increase or decrease the low (deep) tones.
- Balance (Balance)** Set the balance of the left and right loudspeaker for the desired playback.

Surround sound (Surround sound)

Use the **▲/▼** buttons to select **Surround Sound (Surround sound)** and use the **◀/▶** buttons to select **On (On)** or **Off (Off)**.

EQ Setting (Equaliser settings)

You can choose from up to 7 equaliser bands.

Use the **▲/▼** buttons to select **EQ Setting (Equaliser settings)** and use the **OK/▶** button to enter the submenu.

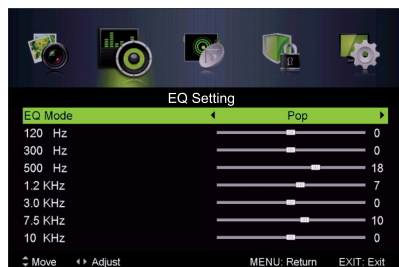

EQ Mode (Equaliser mode)

Use the **▲/▼** buttons to select **EQ Mode (Equaliser mode)** and use the **◀/▶** buttons to select a mode. The following option are available: **Off (Off)**, **Rock (Rock music)**, **Pop (Pop music)**, **Jazz (Jazz music)**, **User (User)**.

Using the menus

AVL (Automatic volume limiter)

Set the automatic volume control function. Use the ▲/▼ buttons to select **AVL** and then use the ◀/▶ buttons to select **On (On)** or **Off (Off)**.

SPDIF

Use the ▲/▼ buttons to select **SPDIF** and then use the ◀/▶ buttons to select **Off (Off)** / **Auto (Automatic)** / **PCM**.

Audio Description (Audio description)

Use the ▲/▼ buttons to select **Audio Description (Audio description)** and then use the **OK/▶** button to enter the submenu.

In it you can turn the Audio Description on (On) or off (Off) and set the volume ratio of a standard audio track and audio description track.

Note:

The audio description is placed in the broadcast by the TV station. Find out which TV stations and which programs have audio description available.

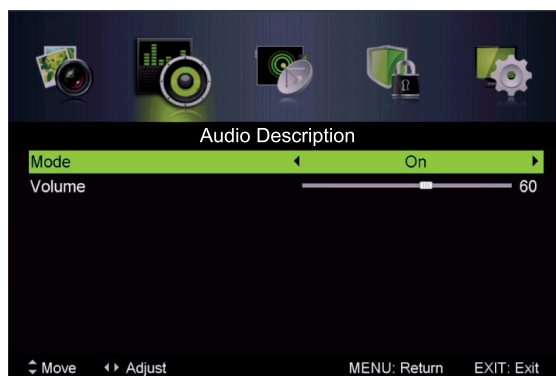

Mode (Mode)

Use the ▲/▼ buttons to select **Mode (Mode)** and then use the ◀/▶ buttons to select **On (On)** or **Off (Off)**. When the mode is on, the volume may be set by the user.

Sound Type (Sound type)

Use the ▲/▼ buttons to select **Sound Type (Sound type)** and then use the ◀/▶ buttons to select a mode. The following options are available: **Stereo** / **Dual I**, **Dual II**, **Mixed (mixed)**.

6.3 Channel (Channel) menu

Press **MENU** to show the main menu.

Use the ◀/▶ buttons to select **Channel (Channel)** and enter the menu by pressing the **OK/▼** button.



1. Press ▲/▼ to select the desired item that you wish to modify.
2. Use the **OK** button to enter the submenu.
3. After completing setup, press the **MENU** button to save and to return to the previous menu.

Tuner Type (Tuner type)

Use the ▲/▼ buttons to select **Tuner Type (Tuner type)** and then use the ◀/▶ buttons to select **Antenna (Antenna)** or **Cable (Cable)**.

Auto Scan (Automatic search)

Use the ▲/▼ buttons to select **Auto Scan (Automatic scanning)** and then use the **OK/▶** button to enter the submenu.

Tuner type Antenna

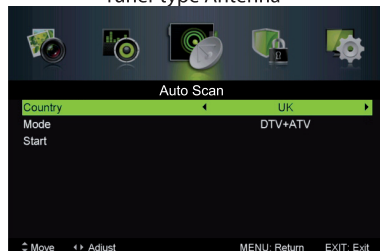

Tuner type Cable

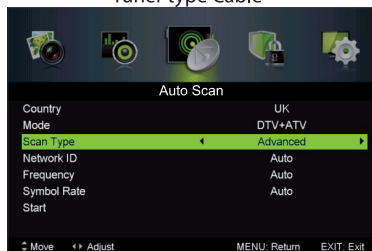

Country (Country)

Use the ◀/▶ buttons to select a country.

Mode (Mode)

Use the ◀/▶ buttons to select a mode.

Scan Type (Scan type)

Use the ◀/▶ buttons to select the scan type: **Advanced (Advance)**, **Quick (Quick)**, **Full (Full)**.

Network ID (Network ID)

Use the ◀/▶ buttons to select the network ID: **Auto** (Automatic) or enter a numerical value.

Frequency (Frequency)

Use the ◀/▶ buttons to select a frequency. **Auto** (Automatic) or enter a numerical value.

Symbol Rate (Symbol Rate)

Use the ◀/▶ buttons to select the symbol rate: **Auto** (Automatic) or enter a numerical value.

Start

Press the **OK/▶** button to start the automatic scan. The television will first scan the digital channels and thereafter the analogue channels. Before launching the automatic scan, it is necessary to select an antenna. An incorrectly set antenna may result in certain channels not being found. The number of the found channels does not include coded channels.

Using the menus

Manual Scan (Manual search)

Use the ▲/▼ buttons to select **Manual Scan (Manual scanning)** and then use the **OK/▶** button to enter the submenu.

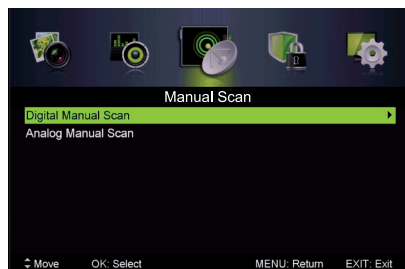

Digital Manual Scan (Digital Manual Search)

Use the ▲/▼ buttons to select **Digital Manual Scan (Digital manual scanning)** and then use the **OK/▶** button to enter the submenu.

Tuner type Antenna

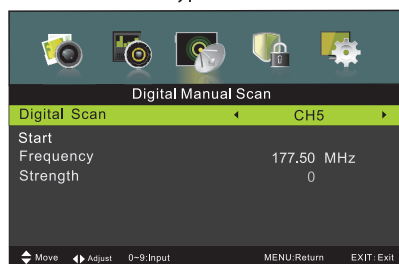

Tuner type Cable

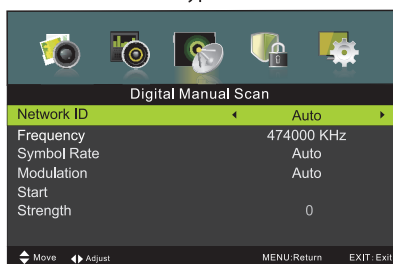

Network ID (Network ID)

Use the ◀/▶ buttons to select the network ID: **Auto** (Automatic) or enter a numerical value.

Frequency (Frequency)

Use the ◀/▶ buttons to select a frequency. **Auto** (Automatic) or enter a numerical value.

Symbol Rate (Symbol Rate)

Use the ◀/▶ buttons to select the symbol rate: **Auto** (Automatic) or enter a numerical value.

Modulation (Modulation)

Use the ◀/▶ buttons to select the modulation type: **Auto (Automatic), 16QAM, 32QAM, 64QAM, 128QAM, 256QAM.**

Start

Press the **OK/▶** button to start the automatic scan.

Analogue Manual Scan (Analogue manual search)

Use the ▲/▼ buttons to select **Analogue Manual Scan (Analogue manual scanning)** and then use the **OK/▶** button to enter the submenu.

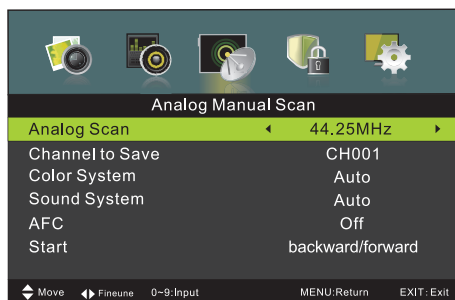

Analogue Scan (Analogue scanning)

Use the ◀/▶ buttons to select **Analog Scan (Analogue scanning)**.

Channel to Save (Channel to save)

Use the ◀/▶ buttons to select **Channel to Save (Channel to save): digital number**.

Color System (Colour system)

Use the ◀/▶ buttons to select the colour system: **Auto (Automatic)**, **PAL** or **SECAM**.

Sound System (Sound system)

Use the ◀/▶ buttons to select the audio system: **Auto (Automatic)**, **DK**, **BG**, **I** or **L**.

Modulation (Modulation)

Use the ◀/▶ buttons to select the modulation type: **Auto (Automatic)**, **16QAM**, **32QAM**, **64QAM**, **128QAM**, **256QAM**.

AFC (Automatic fine tuning)

Use the ◀/▶ buttons select **On (On)** or **Off (Off)**.

Start

Press the **OK/▶** button to start the scan.

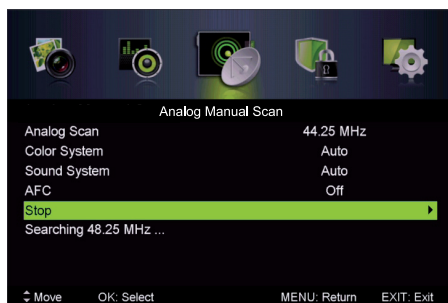

Using the menus

Channel Edit (Channel editing)

Use the ▲/▼ buttons to select **Channel Edit (Channel editing)** and the **OK /▶** button to enter the submenu.

- ■ ■ The coloured buttons are used as short cut buttons for programming channels. First use the ▲/▼ buttons to highlight a channel that you wish to delete, move or skip and then:
- **With the red** button delete the channel.
 - **With the green** button set the skip channel function.
 - **With the blue** button designate a channel that is to be moved. Then use the ▲/▼ buttons to select a position where you wish to move the channel to.



Favorite Manager (Favourites manager)

Use the ▲/▼ buttons to select **Favorite Manager (Favourites manager)**, then press the **OK** button to enter the submenu.



Common Interface (CI interface)

Use the ▲/▼ buttons to select **Common Interface (CI interface)** and use the **OK/▶** button to enter the submenu. The mode is available when a CI card is inserted in the DTV mode.

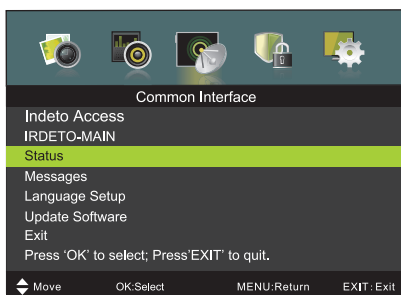

Signal Information (Information about the signal)

Use the ▲/▼ buttons to select **Signal Information (Information about the signal)** and then use the **OK** button to enter the submenu for displaying detailed signal information. This function is only available in the DTV mode.

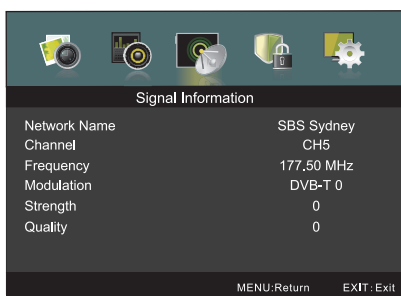

6.4 Lock (Lock) menu

Press **MENU** to show the main menu.

Use the **◀/▶** buttons to select **Lock system (Lock)** and enter the menu by pressing the **OK/▼** button.



1. Press **▲/▼** to select the desired item that you wish to modify.

2. Use the **OK/◀/▶** button to enter the submenu.

3. After completing setup, press the **MENU** button to save and to return to the previous menu.

The factory-set password is 0000. In the event that you forget the password that you have set, please contact an authorised service centre.

Enable (Enable)

Use the **▲/▼** buttons to select **Enable (Enable)** and then use the **◀/▶** buttons to select **On (On)** or **Off (Off)**.

The **Channel Locks (Channel locks)**, **Parental Rating (Parental Rating)** and **Lock Keypad (Lock keypad)** submenus are available only when the function **Enable (Enable)** is turned on (On).

Channel Locks (Channel locks)

Use the **▲/▼** buttons to select **Channel Locks (Channel locks)** and the **OK/▶** button to enter the submenu.

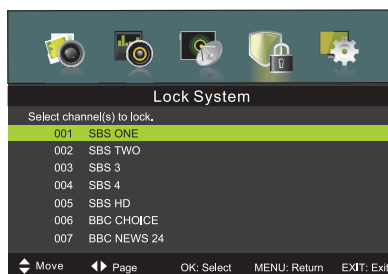

Parental Rating (Parental rating)

Use the **▲/▼** buttons to select **Parental Rating (Parental rating)** and then use the **◀/▶** buttons to set the respective value.

Lock Keypad (Lock keypad)

Serves to lock the buttons to prevent their undesirable use or settings, e.g. by small children.

Use the **▲/▼** buttons to select **Lock Keypad (Lock keypad)** and then use the **◀/▶** buttons to select **On (On)** or **Off (Off)**.

New Password (New password)

Use the **▲/▼** buttons to select **New Password (New password)** and then enter a 4-digit number. The password must be entered twice.

Clear Lock (Delete lock)

Use the **▲/▼** buttons to select **Clear Lock (Delete lock)**.

Hotel Mode (Hotel mode)

Use the **▲/▼** buttons to select **Hotel Mode (Hotel mode)**.

6.5 Setup menu (Setup)

Press **MENU** to show the main menu.

Use the ◀/▶ buttons to select **Setup (Setup)** and enter the menu by pressing the **OK/▼** button.

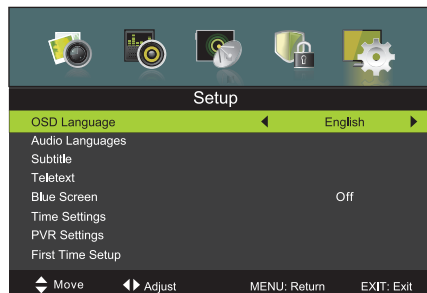

1. Press ▲/▼ to select the desired item that you wish to modify.
2. Use the **OK/◀/▶** button to enter the submenu.
3. After completing setup, press the **MENU** button to save and to return to the previous menu.

OSD Language (OSD language)

Use the ▲/▼ buttons to select **OSD Language (OSD language)** and perform the setting using the ◀/▶ buttons.

Audio Languages (Audio languages)

Use the ▲/▼ buttons to select **Audio Languages (Audio languages)** and then use the **OK** button to enter the submenu.

Use the ▲/▼/◀/▶ buttons to select the primary (Audio Primary Language) and the secondary (Audio Secondary Language) audio language.

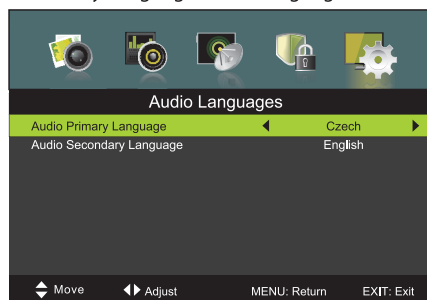

Subtitle (Subtitles)

Use the ▲/▼ buttons to select **Subtitle (Subtitles)** and then use the **OK** button to enter the submenu.

Mode (Mode)

Use the ▲/▼ buttons to select **Mode (Mode)** and use the ◀/▶ buttons to select **On (On)** or **Off (Off)**.

Use the ▲/▼/◀/▶ buttons to select the primary (Subtitle Primary Language) and the secondary (Subtitle Secondary Language) subtitle language.

Hearing Impaired (Subtitles for the hearing impaired)

Use the ▲/▼ buttons to select **Hearing Impaired (Subtitles for the hearing impaired)** and then use the ◀/▶ buttons to select **On (On)** or **Off (Off)**.

Teletext

Teletext is only available in DTV or ATV mode.

Use the ▲/▼ buttons to select **Teletext** and use the **OK/▶** button to enter the submenu

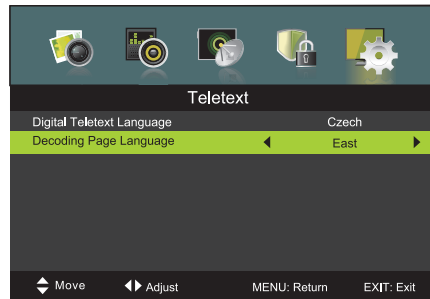
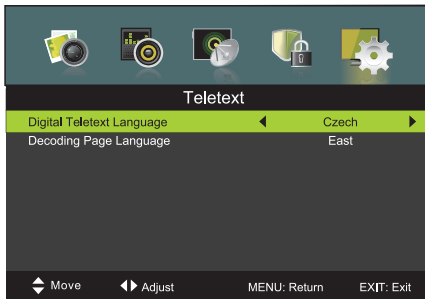

In DTV mode, use the ◀/▶ buttons to select **Digital Teletext Language (Digital teletext language)**.

In ATV mode, use the ◀/▶ buttons to select **Decoding Page Language (Decoding page language)**.

Blue Screen (Blue screen)

Use the ▲/▼ buttons to select **Blue Screen (Blue screen)**, then press the **OK/▶** button to enter the submenu.

Time Setting (Setting the time)

Use the ▲/▼ buttons to select **Time Setting (Time settings)** and use the **OK/▶** button to enter the submenu.



Using the menus

OSD Time (OSD display time)

Use the ▲/▼ buttons to select **OSD Time (OSD display time)** and set the value using the ◀/▶ buttons. The following options are available: **Off (Off), 10 seconds, 20 seconds, 30 seconds, 60 seconds.**

Sleep timer (Shut off timer)

Set the timer period after which the television will turn off automatically.

Use the ▲/▼ buttons to select **Sleep timer (Shut off timer)** and set the value using the ◀/▶ buttons. The following options are available: **Off (Off), 5 minutes, 15 minutes, 30 minutes, 60 minutes, 90 minutes, 120 minutes, 240 minutes.**

Auto Sleep (Automatic shut-off)

Use the ▲/▼ buttons to select **Auto Sleep (Automatic shut off)** and the ◀/▶ buttons to set the value **Off (Off), 3 hours, 4 hours or 5 hours.**

Time Zone (Time zone)

Set the time zone in which you are located.

Use the ▲/▼ buttons to select **Time Zone (Time zone)** and then use the **OK/▶** to enter the submenu.



Time (Time)

Use the ▲/▼ buttons to select **Time (Time)** and use the **OK/▶** button to enter the submenu.

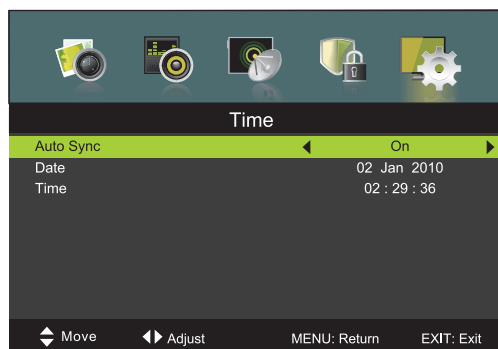

Set **Auto Sync (Automatic synchronisation)** to **Off (Off)**, **On/Off Timer (On/Off timer)** to **On (On)** and then you can set the time manually.

Note:

In the event of a power outage, the time will be reset and it will be necessary to set it again.

PVR Setting (PVR settings)

Use the ▲/▼ buttons to select **PVR Setting (PVR settings)** and press the **OK** button to enter the submenu. The system will check whether a USB device is connected.



First Time Setup (First time setup)

Use the ▲/▼ buttons to select **First Time Setup (First time setup)** and press the **OK** button to enter the submenu.

The default password is "0000".



Using the menus

Reset (Reset)

Use the ▲/▼ buttons to select **Reset (Reset)** and then use the **OK** button to enter the submenu.

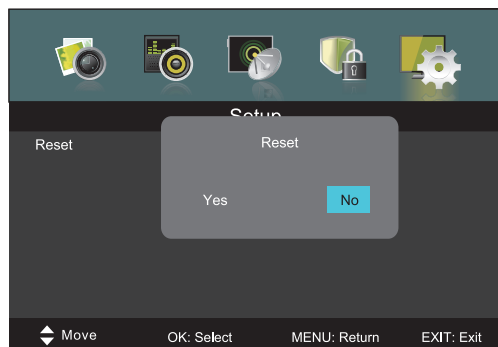

You will be asked to confirm that you wish to perform a reset. Select **Yes (Yes)** to perform it.

EPG menu

Press the **EPG** button on the remote control to enter the EPG menu.

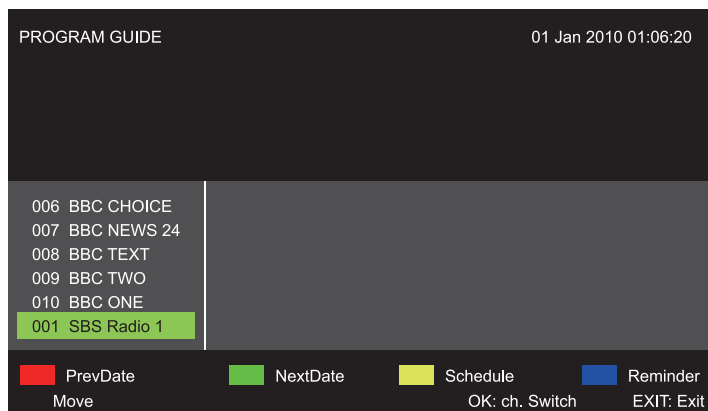

Note:

The information in the EPG menu depends on the operator of the given channel.

ATV / SCART / HDMI / AV / YPbPr

1. **PC Setting (PC settings)** in the **Picture (Picture)** menu is only available in the PC mode. **Screen Mode (Screen Mode)** in the **Picture (Picture)** menu is only available in the **HDMI Input (HDMI input)** mode.
2. **Audio Description (Audio description)** and **Sound Type (Sound type)** are not valid in the **Audio (Audio)** menu.
3. The SCART, HDMI, AV / YPbPr/PC modes do not support the **Channel (Channel)** menu.
4. **Parental Rating (Parental settings)** a **Channel Locks (Channel locks)** in the **Lock (Lock)** menu are not available for the SCART, HDMI, AV / YPbPr modes. **Parental Rating (Parental settings)** is not available for the **ATV mode**.
5. **Audio Language (Audio language)**, **Subtitle (Subtitles)** and **PVR Setting (PVR settings)** in the **Setup (Setup)** menu are not available for the SCART, AV/PC modes. **Audio Language (Audio language)**, **Subtitle (Subtitles)**, Teletext and **PVR Setting (PVR settings)** in the **Setup (Setup)** menu are not available for the HDMI / YPbPr modes.

7. USB control

Before entering the **USB** menu it is necessary to first insert a USB device, then press the **SOURCE** button and select the input **USB** source.

Use the ◀▶ buttons to select **USB** as the input source and press the **OK** button to enter the submenu.

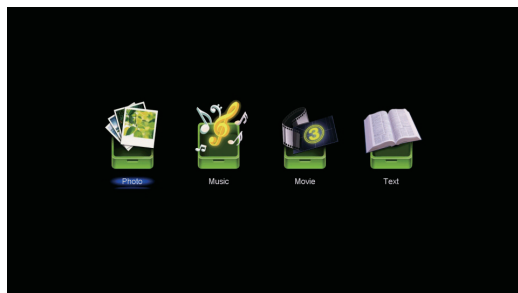

Use the ◀▶ buttons to select the desired item and press the **OK** button to enter the submenu.

7.1 Photo (Photos)

Use the ◀▶ buttons to select **Photo (Photos)** from the main menu and press the **OK** button to enter the submenu.

Use the ◀▶ buttons to select a drive disk and press the **OK** button to enter the disk menu.

Use the ◀▶ buttons to select the option to return to the previous menu.

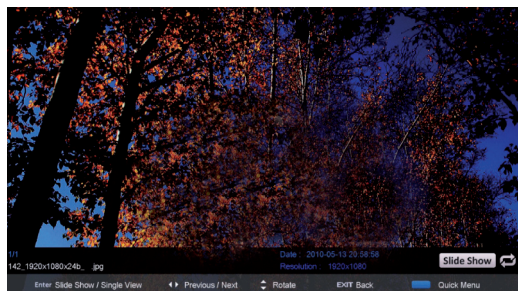

7.2 Music (Music)

Use the ◀▶ buttons to select **Music (Music)** from the main menu and press the **OK** button to enter the submenu.

Use the ▲▼ buttons to select a drive disk and press the **OK** button to enter the disk menu.

Use the ▲▼ buttons to select the option to return to the previous menu.

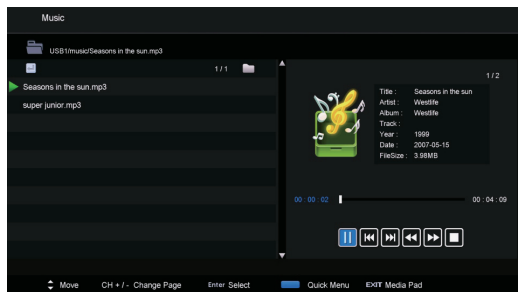

When the selected item is highlighted, file information will be shown on the right hand side.

7.3 Movie (Movie)

Use the ◀▶ buttons to select **Movie (Movie)** from the main menu and press the **OK** button to enter the submenu.

Use the ▲▼ buttons to select a drive disk and press the **OK** button to enter the disk menu.

Use the ▲▼ buttons to select the option to return to the previous menu.



7.4 Text (Text)

Use the ◀▶ buttons to select **Text (Text)** from the main menu and press the **OK** button to enter the submenu.

Use the ▲▼ buttons to select a drive disk and press the **OK** button to enter the disk menu.

Use the ◀▶ buttons to select the option to return to the previous menu.

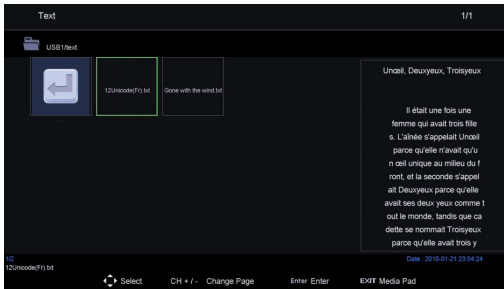

When the selected item is highlighted, file information will be shown on the right hand side.

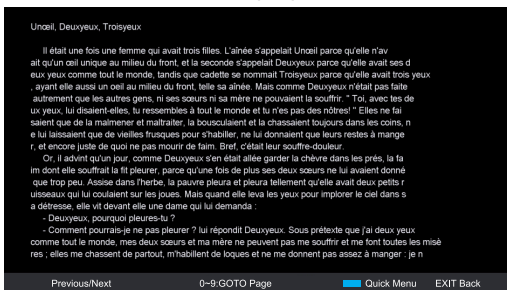

8. Troubleshooting guide

Troubleshooting

Before contacting the service centre, please perform the following simple checks. If problems persist, disconnect the TV and contact a service centre.

PROBLEM	POSSIBLE SOLUTION
No picture and sound	<ul style="list-style-type: none"> - Check that the power cord is connected to the wall power socket. - Check that you have not pressed the POWER button on the front panel of the TV receiver. - Check the brightness and contrast settings.
Normal picture but no sound.	<ul style="list-style-type: none"> - Check the volume. - Is the sound muted? Press the MUTE button. - Try another channel, the problem may be on the other side of the broadcast. - Are the audio cables connected correctly?
The remote control does not work.	<ul style="list-style-type: none"> - Check that there is no obstacle between the television and the remote control. - Are the batteries inserted correctly? - Is the control mode setup correctly? TV, VCR etc.? - Insert new batteries.
The TV suddenly turns off.	<ul style="list-style-type: none"> - Is the time switch set? - Check the power supply settings. Power supply interruption. - The automatic shut off function is set and the tuned station is not transmitting a signal, or perhaps the remote control has not been used for a longer period of time.
The picture appears slowly after the television is turned on.	<ul style="list-style-type: none"> - This is normal; during the initialisation process of the appliance the picture is turned off. If the picture does not appear within five minutes, please contact your service centre.
No colours or wrong colours or poor picture quality	<ul style="list-style-type: none"> - Set the colours in the options menu. - Maintain a sufficient distance between the television and the video recorder. - Try another channel, the problem may be on the other side of the broadcast. - Are the video cables connected correctly? - Activate one of the functions for renewing the brightness of the picture.
Horizontal/vertical strip or broken picture.	<ul style="list-style-type: none"> - Check that local interference is not occurring, e.g. from other electrical appliances.
Poor reception of certain channels	<ul style="list-style-type: none"> - Problems with the station or cable television. Tune into another station or frequency of the same station. - The station signal is weak or is experiencing interference, redirect your antenna or have it inspected. (A bad antenna is the most frequent cause of reception problems). - Identify the source of any interference.
Lines or stripes in the picture	<ul style="list-style-type: none"> - Check the antenna (change the direction of the antenna).
No output from one of the loudspeakers	<ul style="list-style-type: none"> - Set the balance in the options menu.

Note:

Problem in the VGA mode (only for the VGA mode).

PROBLEM	POSSIBLE SOLUTION
The signal is out of range.	- Set the resolution, horizontal frequency or vertical frequency. - Check whether a signal cable has not come loose. - Check the input source.
Vertical stripe or band on the background and horizontal noise and incorrect position of the picture.	- Launch automatic setup or adjust the timing, phase or horizontal/vertical shift.
Inconsistent colours or single-colour picture.	- Check the signal cable. - Reinstall the video card in the PC.

Maintenance

Appropriate maintenance can prevent premature ageing of the appliance. Regular and thorough cleaning can prolong the lifetime of your television. Do not forget to turn off the power supply and disconnect the power cord before cleaning.

Cleaning the screen

1. Dampen a soft wiping cloth into a solution of lukewarm water and dishwashing detergent. Wring out the cloth until it is almost dry and then use it to wipe the screen.
2. Make sure that no water remains on the screen; allow the appliance to completely dry before turning it on.

Cleaning the cabinet

Wipe dirt and dust away using a soft dry wiping cloth. Do not use a damp wiping cloth.

In the event of a long term absence



If you will not be using the television for a longer period of time (for example during vacation time), it is advisable to disconnect the power cord and in this way protect the appliance against possible damage by lightning or overvoltage in the power grid.

Technical specifications

9. Technical specifications

Model	SLE 40F11
Diagonal	40" (102 cm)
Power consumption	70 W
Power consumption while in stand-by mode	≤ 0,5 W
Nominal voltage	110 - 240 V ~ 50/60 Hz
Remote control	Yes
VESA wall mount	No
Dimensions with the stand (W x H x D)	927 x 584 x 200 mm
Dimensions without the stand (W x H x D)	927 x 551 x 92 mm
Dimensions of the packaging (W x H x D)	1025 x 641 x 153 mm
Net weight with the stand	6,7 kg
Net weight without the stand	6,6 kg
Connection	
RF IN	1
AV input	1 (mini)
SCART	1
Component YPbPr	1 (mini)
VGA (D-Sub 15 pin)	1
HDMI	3
SPDIF coaxial	1
USB	1
Supported USB formats	AVI, MPEG, MPEG-4, TS, MKV, FLV, VC-1/WMV9, RMVB, MP3, AAC, WAV, JPG, JPEG, TXT
CI slot	1
Other functions	
WXGA resolution	1920 x 1080
Brightness (cd/m ²)	270
Aspect ratio	16:9
Dynamic contrast	1.000.000:1
Response time (ms)	8 ms
Number of colours	16.7 mil
Adjustable colour temperature	Cool, standard, warm
Viewing angle	H: 178°, V: 178°
Built-in tuner	R840
Video system	PAL, SECAM/MPEG-2, MP@ML, MPEG-2, MP@HL, H.264/PAL
Audio system	BG, DK, I, L/L /MPEG-1 layer 1/2, DD, DD+, AAC, HE-AAC
Stereo sound	NICAM/A2
Audio output	Headphone jack, digital coaxial
PVR recording on USB	Yes
Sound correction	No
Progressive scan	Yes
Time shift function (Timeshift)	Yes
EPG	Yes
Teletext	Yes
Teletext pages	1000
Comb filter	3D
OSD menu	Yes
Zoom	Yes
Noise reduction	Yes
Shut off / start up / sleep timer	Yes
Subtitles	Yes
Audio language	Yes
Channel list	Yes
List of favourites	Yes
Freeze picture	Yes
Radio	Yes
Lock	No
Parental Guidance	Yes
Hotel mode	Yes

Technical specifications may change without prior notice.

10. Information sheet

Manufacturer: FAST ČR, a.s., Černokostecká 1621, 251 01 Říčany, Česká republika

Brand		Sencor
Model		SLE 40F11
Energy Class		A
Screen diagonal in cm / inch	[cm/"]	102/40
Power consumption in on status	[W]	54
Annual power consumption*	[kWh]	79
Power consumption in standby mode	[W]	≤0,5
Resolution	[pixels]	1920 x 1080

* Power consumption of 79 kWh per year, based on the power consumption of a television, operating 4 hours daily for 365 days. Actual power consumption depends on the television usage.

INSTRUCTIONS AND INFORMATION REGARDING THE DISPOSAL OF USED PACKAGING MATERIALS

Dispose of packaging material at a public waste disposal site.

DISPOSAL OF USED ELECTRICAL AND ELECTRONIC APPLIANCES



The meaning of the symbol on the product, its accessory or packaging indicates that this product shall not be treated as household waste. Please, dispose of this product at your applicable collection point for the recycling of electrical & electronic equipment waste.

Alternatively in some states of the European Union or other European states you may return your products to your local retailer when buying an equivalent new product. The correct disposal of this product will help save valuable natural resources and help in preventing the potential negative impact on the environment and human health, which could be caused as a result of improper liquidation of waste. Please ask your local authorities or the nearest waste collection centre for further details. The improper disposal of this type of waste may fall subject to national regulations for fines.

For business entities in the European Union

If you wish to dispose of an electrical or electronic device, request the necessary information from your seller or supplier.

Disposal in other countries outside the European Union

If you wish to dispose of this product, request the necessary information about the correct disposal method from local government departments or from your seller.



This product meets all the basic EU regulation requirements that relate to it.

Changes to the text, design and technical specifications may occur without prior notice and we reserve the right to make these changes.

The original version is Czech.

Address of the manufacturer: FAST ČR, a.s., Černokostelecká 1621, 251 01 Říčany, Česká republika

SENCOR®

EN Warranty conditions

Warranty card is not a part of the device packaging.

This product is warranted for the period of 24 months from the date of purchase to the end-user. Warranty is limited to the following conditions. Warranty is referred only to the customer goods using for common domestic use. The claim for service can be applied either at dealer's shop where the product was bought, or at below mentioned authorized service shops. The end-user is obligated to set up a claim immediately when the defects appeared but only till the end of warranty period. The end user is obligated to cooperate to certify the claiming defects. Only completed and clean (according to hygienic standards) product will be accepted. In case of eligible warranty claim the warranty period will be prolonged by the period from the date of claim application till the date of taking over the product by end-user, or the date the end-user is obligated to take it over. To obtain the service under this warranty, end-user is obligated to certify his claim with duly completed following documents: receipt, certificate of warranty, certificate of installation.

This warranty is void especially if apply as follows:

- Defects which were put on sale.
- Wear-out or damage caused by common use.
- The product was damaged by unprofessional or wrong installation, used in contrary to the applicable instruction manual, used in contrary to legal enactment and common process of use or used for another purpose which has been designed for.
- The product was damaged by uncared-for or insufficient maintenance.
- The product was damaged by dirt, accident of force majeure (natural disaster, fire, and flood).
- Defects on functionality caused by low duality of signal, electromagnetic field interference etc.
- The product was mechanically damaged (e.g. broken button, fall).
- Damage caused by use of unsuitable media, fillings, expendable supplies (batteries) or by unsuitable working conditions (e.g. high temperatures, high humidity, quakes).
- Repair, modification or other failure action to the product by unauthorized person.
- End-user did not prove enough his right to claim (time and place of purchase).
- Data on presented documents differs from data on products.
- Cases when the claiming product cannot be indentified according to the presented documents (e.g. the serial number or the warranty seal has been damaged).

Authorized service centers

Visit www.sencor.eu for detailed information about authorized service centers.