

AUTOMATIC WASHING MACHINE USER'S MANUAL

PHILCO



Famous for Quality the World Over

PL 151 F

Dear customer,

Thank you for buying a PHILCO brand product. So that your appliance serves you well, please read all the instructions in this user's manual.

CONTENTS

PART 1: BEFORE PUTTING INTO OPERATION	2
• Important safety instructions.....	2
• General safety information.....	2
• Recommendations.....	3
PART 2: INSTALLATION	4
• Removal of the transportation screws	4
• Levelling the washing machine.....	4
• Electrical connection.....	5
• Water supply connection.....	5
• Water drain connection.....	6
PART 3: DESCRIPTION OF THE APPLIANCE AND THE CONTROL PANEL	7
• Description of the appliance	7
• Control panel.....	8
• Washing detergent drawer	8
• Program selection dial.....	10
• Display	11
PART 4: WASHING YOUR LAUNDRY	12
• First wash cycle.....	12
• Operating the washing machine	13
• Additional functions.....	13
• Child safety lock	16
PART 5: PROGRAM CHART	17
PART 6: MAINTENANCE AND CLEANING	18
• Water inlet filters.....	18
• Pump filter.....	19
• Washing detergent drawer	19
• Siphon plug	20
• Cabinet of the washing machine	20
• Drum.....	20
• Removal of scale deposits from the washing machine.....	20
PART 7: PRACTICAL INFORMATION	21
PART 8: PREVENTION OF MINOR MALFUNCTIONS	22
PART 9: AUTOMATIC MALFUNCTION DETECTION SYSTEM	24
PART 10: INFORMATION SHEET	25

PART 1: BEFORE PUTTING INTO OPERATION

Important safety instructions

- Read carefully and store for future use.
- The safety of this appliance complies with industry norms and meets legal appliance safety requirements. However, as manufacturers, we consider it our duty to provide you with the following safety instructions.
- It is essential that you store this user's manual in a safe place so that you can use it in the future. If you intend to sell the appliance, give it to another owner, or if you move, always make sure that the user's manual is attached to the appliance, so that the new owner can learn about the operation of the appliance and the relevant warnings.
- Before installation or operation of the appliance you **MUST** carefully read all the safety instructions and the user's manual.
- Before putting the appliance into operation for the first time, check that it has not been damaged during transport.
- Never connect a damaged appliance. If some parts are damaged, contact the supplier.
- If the washing machine is supplied in the winter months, when the temperature falls under 0°C, store the appliance at room temperature for 24 hours before first use.

General safety instructions

- Changing the technical parameters or making any other modifications to the appliance is dangerous.
- During the course of the high temperature program the door heats up to a high temperature. Do not touch the door!
- Ensure that small household pets cannot get into the drum. It is therefore better to always check the inside of the drum before use.
- Items such as coins, safety pins, nails, bolts, stones and other heavy or sharp items can cause considerable damage and do not belong in the appliance.
- Use only the recommended amount of fabric softener and washing detergents. If you use a higher amount than is recommended, the fabric could be damaged.
- Always use the amount of detergent recommended by the manufacturer.
- Small pieces of laundry such as socks, shoelaces, washing bands, etc. should be washed in a special purpose washing bag or in a pillow case, because the individual items could become jammed between the tube and the rotating drum.
- Do not use the washing machine to wash products from metal skeletons, fabrics which are not hemmed or that snag.
- After use, before cleaning or maintenance always disconnect the washing machine from the power supply and turn off the water inlet.
- Never attempt to repair the appliance yourself. Repairs carried out by inexperienced persons may lead to injuries or serious damage to the appliance. Contact your local service centre for repairs. Always request original spare parts.
- Do not use multi-sockets or extension cords.
- Do not plug in the appliance with a defective power cord.
- If the power cord is damaged, have it replaced by the manufacturer or an authorised service technician to prevent hazardous situations.
- Do not pull the power plug out of the power socket by pulling on the cord. Hold the power cord by holding the power plug directly.
- Do not connect the power plug if you have wet hands.
- Never touch the appliance if you have wet hands or feet.

- Never open the detergent drawer while washing.
- Never attempt to open the washing machine door while washing.
- Because the washing machine can become very hot during operation, do not touch the hose during the draining or filling process.
- In the event of any defect, first turn off the appliance, disconnect it from the power supply and shut off the water inlet. Do not attempt to repair the device yourself. Contact the nearest authorised service.
- Do not forget that the packaging material from the washing machine may present a danger to children.
- Do not allow children to play with the washing machine.
- Keep household pets at a safe distance from the washing machine.
- The washing machine should only be used by persons fully instructed about the instructions, provisions and controls described in this user's manual.
- This washing machine is designed for domestic use only. The use of the washing machine for commercial purposes voids the warranty.
- Do not install the appliance on a carpet or another similar surface, which could block the ventilation vents on the underside.
- Do not place the drain hose into a container, bucket or sink.

Recommendation

- Long term contact of washing detergents and fabric softeners with air will cause them to dry out and stick to the walls of the compartments. To prevent this from happening, fill the drawer with washing detergent and fabric softener immediately before washing.
- We recommend the use of a prewash only for heavily soiled laundry.
- Do not exceed the maximum loading capacity of the drum.
- This appliance must not be used by persons (including children) with physical, sensory or psychological impairments or by inexperienced persons, unless properly trained or schooled in the safe use of the appliance, or unless they have been properly supervised by a person who will be responsible for their safety. Children should be supervised so as not to play with the appliance.
- If you will not be using the washing machine for an extended period of time, disconnect it from the power socket, shut off the water inlet and leave the door open so that the inside of the washing machine can dry out and so unpleasant odours are not created.
- As a result of quality control procedures some water may remain in the washing machine. This will not damage the washing machine in any way.
- We recommend that the first wash is performed in the White 90 - 95° program (depending on the model) without any laundry, put 1/2 a measuring cup of washing agent into the second draw for the washing agent.
- Install the washing machine in a location where it will be possible to fully open the door of the washing machine. (Do not install the washing machine in a location where it will not be possible to fully open the door).
- Make sure that there is sufficient ventilation and air circulation around the washing machine.

PART 2: INSTALLATION

Carefully read the entire user's manual before putting your washing machine into operation and store it in a safe place for future reference.

Removal of the transportation screws

- You must remove the transportation screws located in the back part of the washing machine before putting it into operation.
- Loosen the bolts using a correctly sized spanner, turning it anticlockwise.
- Remove the bolts by pulling them out.
- Insert the plastic plugs found in the accessories pouch into the transportation screw holes.
- Carefully store the transportation screws removed from the washing machine for future transport purposes.

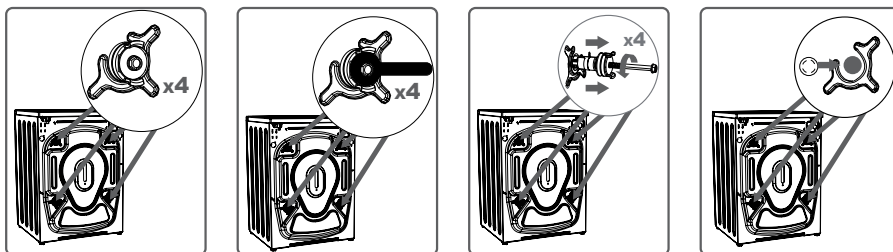

NOTE:

Defects caused by starting the washing machine with the transportation screws installed are not covered by the warranty.

Levelling the washing machine

- Do not place the washing machine on carpets or similar surfaces.
- To ensure quiet and vibration free operation of your washing machine, you should place it on an even, non-slip and rigid surface.

You can level the washing machine by adjusting the adjustable feet:

- First loosen the plastic nut.
- Adjust by screwing out the feet upwards or downwards.
- After levelling the washing machine, re-tighten the plastic nut by screwing it upwards.
- Never level the washing machine on an uneven surface by placing cardboard, wooden blocks, etc. under the feet.

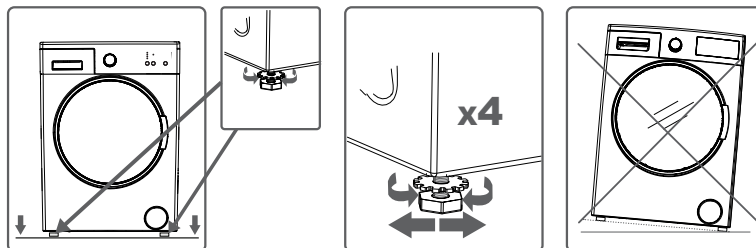

Electrical connection

- Technical specifications of your washing machine: 220-240 V ~ 50 Hz.
- A special grounding plug is attached to the power cord of your washing machine. This plug must be fully inserted into a grounded power socket (with 10 A). The fuse or circuit breaker to which the washing machine is connected should be 10 A. If you do not have such sockets and fuses/circuit breakers at home, have them installed by a qualified electrician.
- Our company takes no responsibility for any damages caused by using the washing machine without grounding.

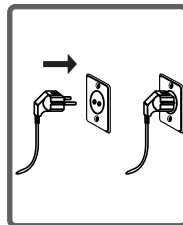

Water supply connection

- Depending on the functions of your washing machine, the washing machine is equipped with either a single water inlet (cold) or a double water inlet (cold/hot). The hose with the white end is intended for the cold water inlet and the hose with the red end is intended for the hot water inlet (on washing machines with a hot and cold water inlet).
- To prevent water from leaking from the connection points, the hose kit also includes 1 seal (for washing machines with a cold water inlet) or 2 seals (for washing machines with hot and cold water inlets). Install these seals on the end of the water inlet hose connected to the tap.
- Connect the hose with the white end to the water inlet valve with the white filter and the hose with the red end to the water inlet valve with the red filter (the second mentioned option applies to washing machines with a hot and cold water connection). Tighten the plastic connecting parts using your hand. A qualified plumber will provide a safer connection.
- The water pressure of 0.1 - 1 MPa in your water tap will ensure a more efficient operation of your washing machine (the pressure of 0.1 MPa equates to a flow rate of more than 8 litres of water per minute from a fully open tap).
- After completing all connections, check that the connections do leak, by fully opening the tap.
- Check that the supply hoses are not bent, broken or cracked.
- Connect the supply hose to a 3/4" threaded water tap.
- If the washing machine has a dual water supply (for hot and cold water), the temperature of the hot water should not exceed 70 °C.

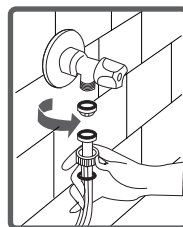
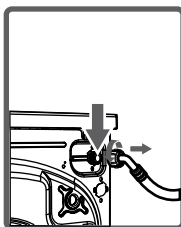
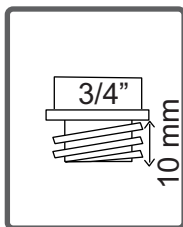
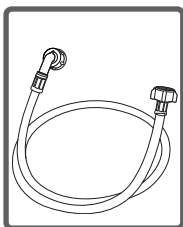

Water drain connection

- Check that the supply hoses are not bent, twisted, cracked or excessively stretched.
- The drain hose should be installed at a height of min. 60 cm and max. 100 cm above the ground.
- The end of the drain hose may be inserted directly into the drain opening or to a special end fitting attached to the drain of the wash basin.
- Never attempt to extend the length of the drain hose by adding extra parts.

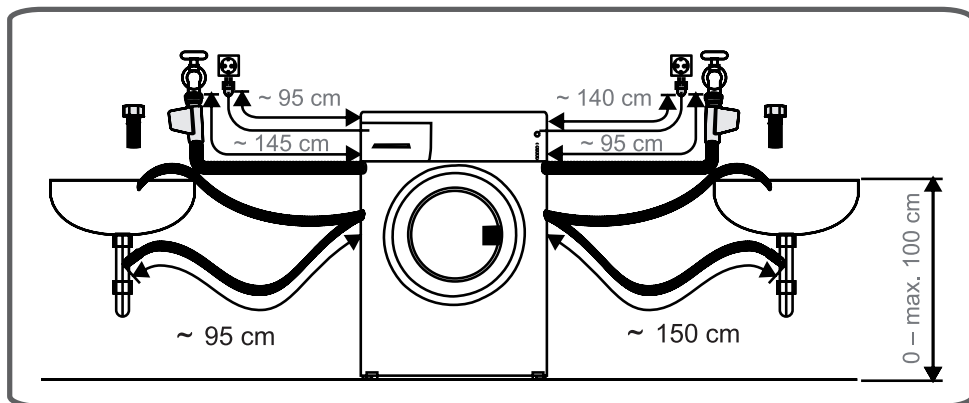
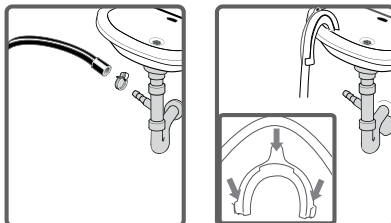

PART 3: DESCRIPTION OF THE APPLIANCE AND THE CONTROL PANEL

Description of the appliance

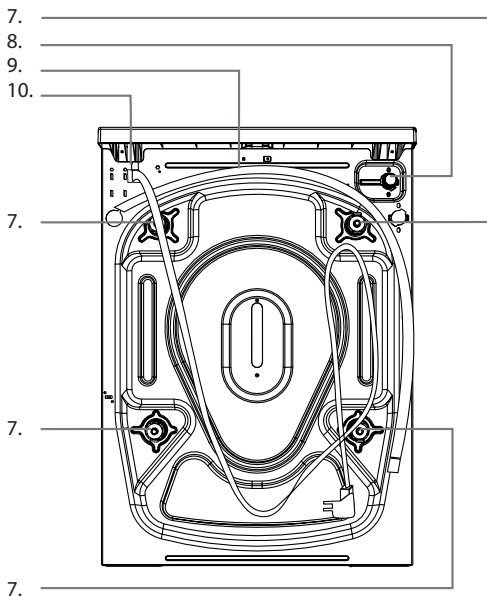
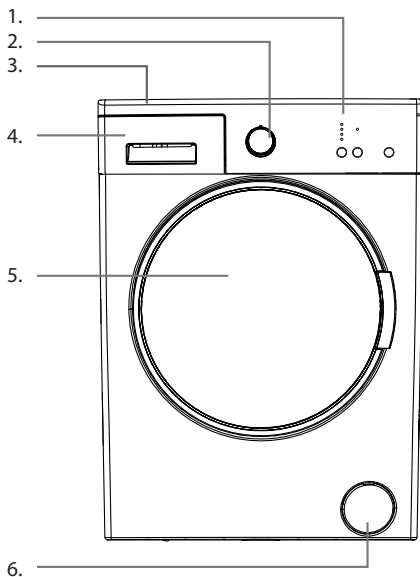

1. Display
2. Program selection dial
3. Top cover
4. Drawer for washing detergents
5. Drum
6. Pump cover

7.

Control panel

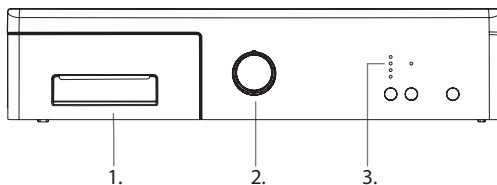

1. Drawer for washing detergents
2. Program selection dial
3. Display

Washing detergent drawer

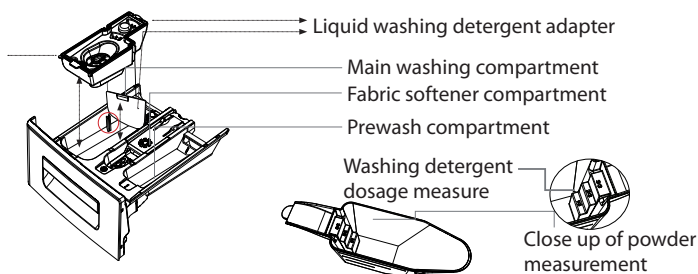
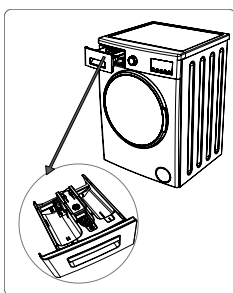

If you are going to use a liquid washing detergent, it is necessary to use a special liquid detergent adapter. (You will find it in the washing machine's accessories.) You can use liquid detergents for all washing programs without a prewash. Place the adapter into the main wash compartment – see illustration above; and pour in the liquid washing detergent as necessary. Do not go over the maximum mark. Always remove the adapter when using a powder washing detergent.

NOTE:
Accessories may vary depending on the model.

Main washing compartment

Into this part of the drawer, place only washing detergent (liquid or powder), lime scale remover, etc. When using a liquid washing detergent use the special adapter. You will find it in the washing machine's accessories.

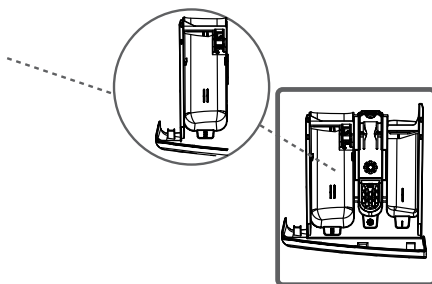

Fabric softener compartment

In this part, only use fabric softener (we recommend that you use the amount and type of fabric softener according to the instructions of the manufacturers of the fabric softener and the laundry). Sometimes remains of the fabric softener may remain in the compartment. This is because fabric softeners are viscous (sticky). To prevent this from occurring, we recommend that you use a fabric softener that is less viscous (i.e. sticky) or you can dilute it using water.

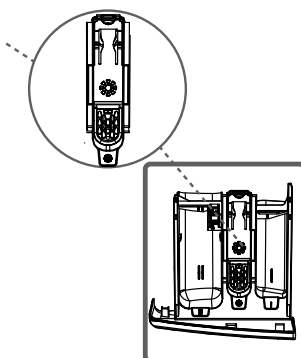

Prewash compartment

Fill this compartment only if the prewash function is selected. We recommend that you use this function only for heavily soiled laundry. More information further in the user's manual.

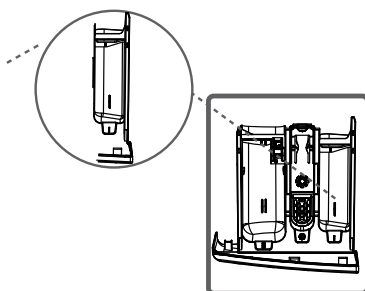

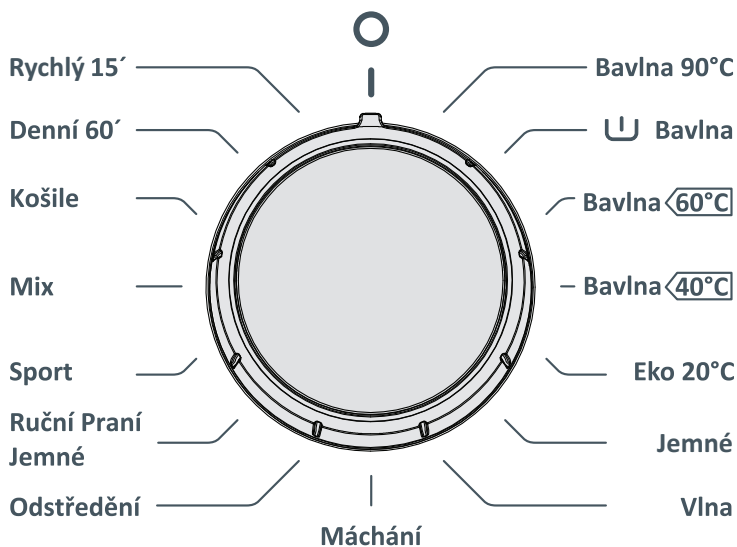

Program selection dial

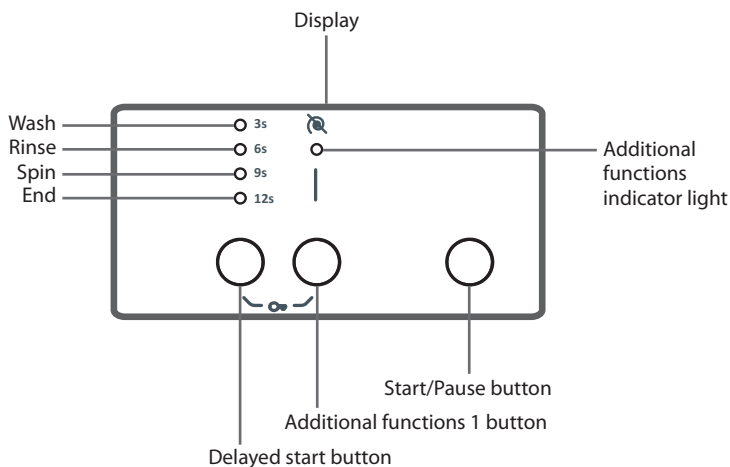

Using the program selection dial, select a program, in which you wish to wash your laundry. The program selection may be done by turning the program selection dial in both directions. When making settings, ensure that the symbol on the program selection dial exactly matches your selected washing program. If you switch the program selection dial to position O (off), the washing machine will drain the water so as to complete (cancel) the program cycle. After completing the draining operation the washing machine will switch to the stand-by mode. Now you can select another program that you want to start.

Display



The display shows the set time of the delayed start, the spinning speed, selected additional functions and the status of the current program (U prewash / washing cycle /  rinsing /  spinning). At the same time, LED lights indicate the current status of the washing program; also combinations of LED lights communicate warning messages.

PART 4: WASHING LAUNDRY

- Connect the washing machine to a power socket.
- Open the water inlet.















First wash cycle

There may be some water left over inside the washing machine from the factory tests. We therefore recommend to perform the first wash without laundry so as to drain this water; put half a measure of standard detergent into compartment 2, which is used for washing detergents and select the program for cotton at 90 °C.

Sorting laundry

- Sort the laundry according to its type (cotton, synthetics, delicates, wool, etc.), washing temperature and the level of dirtiness.
- Never wash whites together with coloured laundry.
- Because your new coloured laundry may release some of its colour, wash it separately.
- Before placing the laundry into the washing machine check pockets for any forgotten items. In this way you will prevent damaging your clothes and the washing machine.
- Do up zips and buttons on the laundry.
- From curtains and drapes remove the plastic or metal hooks or insert the into a wash bag and tie it up.
- Turn clothing such as pants, knitted fabrics, T-shirts and singlets inside out.
- Wash small items such as socks and handkerchiefs in a wash bag.

Washing symbols

	Suitable for bleaching		Do not bleach.
	Standard washing		Maximum ironing temperature is 150 °C
	Maximum ironing temperature is 200 °C		Must not be ironed.
	Dry cleaning possible		Must not be dry cleaned.
	Dry on a flat underlay.		Hang after spin drying.
	Hang to dry.		Do not spin dry.
	Cleaning only with perchloroethylene, gas, alcohol or R113		Cleaning only with perchloroethylene, gas, alcohol or R113
	Dry cleaning with all types of agents		

Operating the washing machine

Placing laundry into the washing machine

- Open the door of the washing machine.
- Check that there are no foreign objects, laundry or animals in the drum. The drum could contain laundry from the previous wash. Remove the laundry from the washing machine.
- Arrange the laundry evenly inside the washing machine. Fold large items such as bed sheets or covers in the manner shown in the illustration below.
- Insert one item at a time.
- When closing the door, make sure that no laundry has been caught in the door.
- Check that the washing machine door is properly closed.
- Firmly close the washing machine door, otherwise the washing machine will not start.

Detergent dosage

The amount of detergent you use in the washing machine depends on the following criteria:

- The consumption of detergent changes with the degree of dirtiness of the laundry.
- Do not use a prewash for lightly soiled laundry and use a small amount of detergent in compartment 2 of the drawer for washing detergents.
- We recommend the use of the prewash only for heavily soiled laundry.
- For excessively soiled laundry select a program with a prewash, put 1/4 of a detergent measuring cup into compartment 1 for washing detergents and put the remainder of the measuring cup into compartment 2.
- Use washing detergents specially made for automatic washing machines. The dosage of the detergent is shown on the packaging.
- Increased water hardness necessitates the use of an increased amount of detergent in the wash.
- Increased laundry loads also necessitate the use of an increased amount of detergent in the wash.
- Pour fabric softeners (conditioners) into the fabric softener compartment in the detergent drawer. Do not go over the MAX mark. Otherwise the fabric softener will flow out the siphon into the water used for washing. If the fabric softener is very thick then dilute it with water before placing it in the compartment. The thick fabric softener could clog up your siphon and so prevent the fabric softener from entering the washing machine.
- You can use liquid detergents for all washing programs without a prewash. Place the adapter into the 2nd compartment intended for the main wash and pour in the liquid washing detergent as necessary.

Selecting programs and functions

Select a program and additional functions appropriate for your laundry using the program selection dial.

Additional functions

Before starting a program, you can add additional functions to improve washing results.

Press the respective button of the additional function. The symbol of the additional function will start flashing on the display. If the symbol of the additional function flashes only for an instant then the function is not available.

NOTE:

Additional functions are not compatible with all the programs.

There is only a limited time period for the selection of an additional function.

The combination of individual additional functions is not available for all programs.

Half load detection system

The washing machine is equipped with a system that detects a half drum load. If you place half the maximum laundry load or even less into the drum, the washing machine will automatically identify this fact and shorten the washing cycle, thus lowering water and power consumption.

Delayed start function

This function makes it possible to delay the start of the wash by 3h, 6h, 9h and 12h.

1. Press the delayed start button. The "3h" indicator light will turn on.
2. Repeatedly press the delayed start button and select the delayed start duration. Each time it is pressed, the respective indicator light will be lit.
3. To activate the delayed start, press any button except for the Start/Pause button.

If you accidentally skip the desired delayed start duration, repeatedly press the delayed start button until you select the correct duration.

If you need to cancel the delayed start function, repeatedly press the delayed start button until the indicator lights turn off.

To start the delayed start function, press the Start/Pause button.

Without spinning (depending on the model)

If you need to spin the laundry, press the button of the additional function. The indicator light next to the  symbol will turn on.

Anti-allergenic (depending on the model)

It is possible to supplement selected programs with an anti-allergenic function, which will add an extra rinse to the selected program. Press the button for the anti-allergenic additional function and the indicator light next to the  symbol will turn on.

Easy iron (depending on the model)

This function helps make ironing easier by crumpling the laundry less. Press the button for the easy wash additional function and the indicator light next to the  symbol will turn on.

Prewash (depending on the model)

The prewash function can be added to the main wash, which is especially suitable for heavily soiled laundry. When using this function, it is necessary to put washing powder into the prewash compartment.

Press the button for the prewash additional function and the indicator light next to the  symbol will turn on.

NOTE:

The prewash function will extend the selected program by a certain amount of time. This time depends on the type of selected program. Do not use liquid washing detergents in the prewash compartment.

Extra rinse (depending on the model)

You can add the extra rinse function to a program. Press the button for the extra rinse additional function and the indicator light next to the  symbol will turn on.

Cold wash (depending on the model)

This function makes it possible to wash laundry in cold water. Press the button for the cold wash additional function and the indicator light next to the  symbol will turn on.

Quick wash (depending on the model)

Selecting this function makes it possible to shorten the washing program time, thus reducing water and energy consumption. We recommend that you use this function if the amount of laundry is less than half a load. Press the button for the quick wash additional function and the indicator light next to the  symbol will turn on.

NOTE:

If you place half the maximum laundry load or even less into the drum, the washing machine will automatically identify this fact and shorten the washing cycle, thus lowering water and power consumption. As soon as the washing machine detects a half load, the indicator light of the  symbol will start flashing on the display.

Starting a program

Start the selected program by pressing the Start/Pause button.

If you press this button while a program is running then this program will be paused.

If the washing machine goes into the stand-by mode, the Start/Pause indicator light will flash shortly.

Cancelling a program

Cancelling a program that is currently running

Turn the program selection dial to the 0 position.

The washing machine will stop and the program will be cancelled.

To drain the water, turn the program selection dial to any position.

The water will be drained automatically.

Now you can select a new program.

End of a program

The selected program will be ended automatically after the last stage.

The end of program indicator light will start flashing on the display.

Move the program selection dial to the 0 position.

Pull the power cord out of the power socket.

Shut off the water inlet.

Open the drum door and take the laundry out.

After completing the wash, leave the door of the washing machine open so that the water remaining in the drum can dry out.

Important

You will only be able to open the door after 2 minutes because they will be blocked. This time is not included in the total washing cycle time.

Child Safety Lock

The child safety lock function serves to block the washing machine controls and prevent an unauthorised change to the program or the washing machine's settings.

Press the delayed start and additional functions buttons for approximately 3 seconds. The indicator light of the child safety lock will be lit.

If you press any button while the child safety lock is activated, a padlock symbol will appear on the display for a moment.

An activated child safety lock enables the restart of a program if it was interrupted by the program selection dial being turned to the 0 position.

To deactivate the child safety lock, press the delayed start and additional functions buttons for approximately 3 seconds. The indicator light of the child safety lock will be lit for a moment.

PART 5: PROGRAM TABLE

Program	Temperature	Max. amount of dry laundry	Compartment	Duration	Laundry description
Bavlna 90° (Cotton 90°)	90 °C	5.0 kg	2	190 min	Heavily soiled cotton, linen laundry (underwear, table cloths, towels (max. 2,5 kg), bed linen, etc.)
Bavlna předpírka (Cotton prewash)	60 °C	5.0 kg	1 + 2	200 min	Soiled cotton, linen laundry (underwear, table cloths, towels (max. 2,5 kg), bed linen, etc.)
Bavlna Eco (Cotton Eco)	60 °C	5.0 kg	2	195 min	Soiled cotton, linen laundry (underwear, table cloths, towels (max. 2,5 kg), bed linen, etc.)
Bavlna 40° (Cotton 40°)	40 °C	5.0 kg	2	195 min	Soiled cotton, linen laundry (underwear, table cloths, towels (max. 2,5 kg), bed linen, etc.)
Eko 20° (Eco 20°)	20 °C	2.5 kg	2	90 min	Lightly soiled cotton, linen laundry (underwear, table cloths, towels (max. 2 kg), bed linen, etc.)
Jemné (Delicates)	40 °C	3.0 kg	2	101 min	Soiled synthetic laundry (nylon socks, shirts, blouses, other synthetic laundry, etc.)
Vlna (Wool)	30 °C	2.0 kg	2	78 min	Woollen laundry suitable for washing in a washing machine.
Máchání (Rinse)	-	5.0 kg	-	17 min	If you need to include an additional rinse in the washing program.
Odstředění (Spin)	-	5.0 kg	-	17 min	If you need to include an additional spin cycle in the washing program.
Ruční praní / Jemné (Hand wash / Delicates)	30 °C	2.0 kg	2	94 min	Laundry suitable for washing by hand or delicate laundry suitable for washing in a washing machine.
Sport (Sport)	30 °C	3.0 kg	2	82 min	Sports apparel
Mix (Mix)	30 °C	3.0 kg	2	125 min	Soiled cotton, synthetic, coloured or linen laundry
Košile (Shirts)	60 °C	3.0 kg	2	177 min	Soiled cotton, synthetic shirts and blouses
Denní 60 min (Daily 60 min)	60 °C	2.0 kg	2	60 min	Short program for soiled cotton, coloured and linen laundry – 60 °C for 60 minutes.
Rychlý 15 min (Quick 15 min)	30 °C	2.0 kg	2	15 min	Short program for lightly soiled cotton, coloured and linen laundry.

NOTE:

The resulting washing cycle time may vary depending on the amount of laundry, type of water, ambient temperature, selection of additional functions, etc.

Dose the amount of washing powder based on the amount of laundry placed into the drum of the washing machine.

PART 6: MAINTENANCE AND CLEANING

- Disconnect the washing machine from the power socket.
- Shut off the water inlet.

CAUTION!

The washing machine and its components could be damaged if you use agents containing solvents. Do not use washing detergents or fabric softeners containing solvents.

Water inlet filters

There are filters connected to the hose ends at the tap end and at the end of the inlet valves, which prevent dirt and foreign materials contained in water entering the washing machine. If the washing machine is not filling up with a sufficient amount of water despite the water inlet being open, clean these filters.

- Disconnect the supply hose.
- Using tweezers take the filters out of the inlet valves and clean them with a brush.
- Using your hand, take out the filters on the supply hoses at the end connected to the tap together with the seals and clean them.
- After cleaning the filters, put them back in the same way.

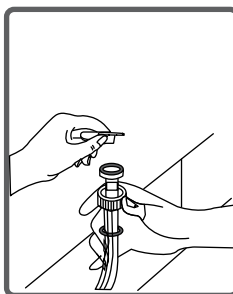
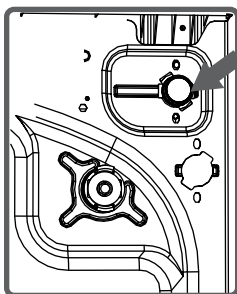

WARNING:

The water inlet filters may become clogged as a result of a connection to poor quality water or insufficient maintenance, etc. Dirty filters result in water leaks that may cause damage to the washing machine and property. Damages caused by incorrect maintenance of the filters are not covered by the warranty conditions.

Pump filter

The pump filtration system extends the life of the pump, which is used for draining dirty water. It ensures that lint from the laundry does not enter the pump. We recommend you clean the pump filter every 2-3 months. Clean the pump filter as follows:

- Open the cover on the bottom strip using the measuring cup or adapter (depending on the model). Before opening the filter cover, place a container in front of it, into which the water remaining in the washing machine will flow.
- Loosen the filter cover by turning it anticlockwise and drain the water.
- Remove all foreign material from the filter.
- Check by hand that the pump rotates.
- After cleaning the pump, return the filter by turning it clockwise.
- Reattach the kick plate cover.
- Don't forget that if you do not reinstall the filter correctly, water will leak from your washing machine.

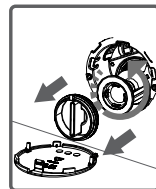
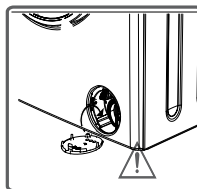
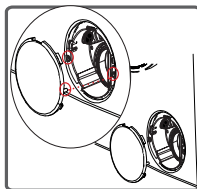
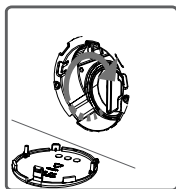
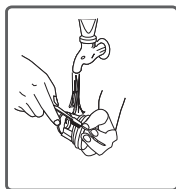
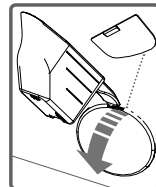

WARNING:

Danger of scalding!

Because the water in the pump may be very hot, wait until it has cooled down.

Drawer for washing detergents

Over time washing detergent deposits may accumulate in the drawer and in the washing machine opening. Therefore, the washing detergent drawer needs to be regularly cleaned from accumulated deposits. Take the drawer out as follows:

- Pull the drawer out completely.
- Fully press down the lid of the siphon inside the drawer and pull the drawer until you pull it out.
- Wash using water and a brush.
- Remove the deposits accumulated inside the drawer opening without them being allowed to enter the washing machine.
- Once the drawer is dry, insert it back into the washing machine in the reverse sequence here described.

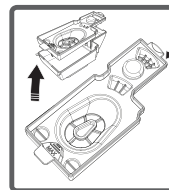
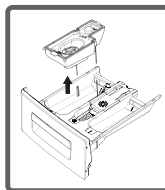
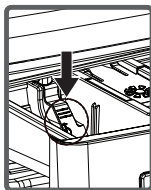
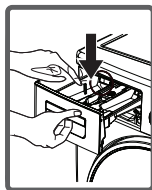
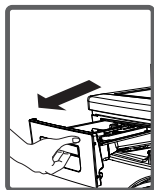

Siphon plug

Take out the washing detergent drawer. Pull out the siphon plug and thoroughly clean off fabric softener residue. Reinsert the cleaned siphon plug in its place. Check that it is properly inserted. Siphon plug

Washing machine cabinet

Clean the washing machine from the outside using lukewarm water and a gentle cleaning agent, which will not damage the surface coat of the washing machine cabinet. After rinsing with clean water, wipe the washing machine with a soft and dry wiping cloth.

Drum

Do not leave any metal items such as pins, paper clips or coins inside the washing machine. These items can cause rusty stains on the drum. If you wish to remove these stains, use a cleaning agent not containing chloride and follow the instructions of the cleaning agent's manufacturer. Never use steel wool used for dishes, or any other similar abrasive items to clean rusty stains.

Removing scale deposits from the washing machine

We recommend the use of a commonly available scale remover and to follow the instructions printed on the packaging.

WARNING:

Scale removal mixtures contain acids and may cause discolouration of your laundry and may have a negative effect on your washing machine.

PART 7: PRACTICAL INFORMATION

Alcoholic beverages: First prewash the stain in cold water, then apply glycerine and water and rinse in a solution of water and vinegar.

Shoe polish: First lightly scrub the stain without damaging the fabric using washing detergent and rinse. If the stain does not go away, apply a solution of one part pure alcohol (96 percent) and two parts water and subsequently wash in lukewarm water.

Tea and coffee: Stretch the part of the laundry with the stain over the top of a pot and rinse with water that is as hot as the fabric will handle. If it is appropriate for your laundry, wash the stain in bleaching lye.

Chocolate and cocoa: Leave your laundry in cold water and scrub with soap or washing detergent, then wash in water that is as hot as the fabric will handle. If an oily stain remains on your laundry, wash in hydrogen peroxide (concentration 3%).

Ketchup: After scratching away dried residues without damaging the laundry, leave to soak for about 30 minutes in cold water and wash with a washing detergent.

Bouillon, eggs: Remove dried residues and wipe with a sponge or a soft wiping cloth dipped in cold water. Apply washing detergent and wash in diluted lye.

Greasy and oily stains: First wipe away residues. Apply washing powder to the stain and then wash in lukewarm water soapy water.

Mustard: First apply glycerine to the stain. Apply washing powder and then wash. If the stain does not disappear, apply alcohol to the stain (for synthetics and coloured laundry use a solution of 1 part alcohol and 2 parts water)

Blood: Leave your laundry to soak in cold water for 30 minutes. If the stain does not disappear, dip into a solution of water and ammonia (3 spoons of ammonia per 4 litres of water) for about 30 minutes.

Cream, ice cream and milk: Leave your laundry in cold water and apply washing detergent to the stain. If the stain does not disappear, apply lye to it in the correct concentration for the given type of fabric (do not use lye on coloured laundry).

Soil: Remove soil stains as soon as possible. Wash in washing detergent and if it does not disappear, apply oxygenated water (concentration 3%).

Ink: Dip the stain in cold water and wait until the ink dissolves in the water. Then apply water with lemon juice a washing detergent to the stain, wait about 5 minutes and then wash.

Fruit: Stretch the part of the laundry with the stain over the top of a pot and pour cold water on it. Pour hot water on to the stain. Apply cold water and glycerine. Wait 1-2 hours and sprinkle with white vinegar, then rinse.

Grass stains: Apply washing detergent to the stain. If it is appropriate for this type laundry, wash the stain in lye. To woollen clothing apply alcohol. (For coloured clothing use a solution of 1 part pure alcohol and 2 parts water).

Oil paints: You should remove the stains before they dry using a solvent. Then apply a washing detergent and wash.

Scorch stains: If your laundry will allow it, you can put lye into the washing water. For woollen laundry you should cover the stain with a wiping cloth dipped in oxygenated water, place a dry wiping cloth over this and iron over the stain. After rinsing you should thoroughly wash the laundry.

PART 8: PREVENTION OF MINOR MALFUNCTIONS

All necessary repairs of the washing machine should be performed by an authorised service centre. If it is necessary to repair your washing machine or you are unable to remedy the malfunction using the information below:

- Disconnect the washing machine from the power socket.
- Shut off the water inlet.
- Contact the nearest authorised service.

MALFUNCTION	POSSIBLE CAUSE	REMEDY
Your washing machine is not working.	It is not connected to a power socket.	Connect the power plug to the power socket.
	The fuse has burnt out.	Replace the fuse.
	A power outage occurred.	Check whether the electricity is working.
	You didn't press the Start/pause button.	Press the Start/pause button.
	The program selection dial is in the STOP position (off).	Turn the program selection dial to the desired position.
Your washing machine is not filling up with water.	The washing machine door is not properly shut.	Close the door properly. You should hear it click in.
	The water inlet is shut off.	Open the water inlet.
	The supply hose may be bent.	Check the supply hose.
	The supply hose is clogged.	Clean the supply hose filters. (*)
	The inlet valve filter is clogged.	Clean the inlet valve filters. (*)
Your washing machine is not draining water.	The washing machine door is not properly shut.	Close the door properly. You should hear it click in.
	The drain hose is clogged or bent.	Check the drain hose.
The washing machine is vibrating.	The pump filter is clogged.	Clean out the pump filter. (*)
	The washing machine is not levelled.	Level the washing machine. (**)
	You didn't remove the transporting screws.	Remove the transporting screws. (**)
	There is a small laundry load in the drum.	This will not damage the washing machine in any way.
	The washing machine is overloaded or the laundry is arranged unevenly.	Do not insert more laundry than the recommended load and check that the laundry is evenly arranged inside the washing machine.
	The washing machine is leaning against a hard surface.	Avoid installing the washing machine leaning on a hard surface. When installing the washing machine, leave a free space of 2 cm between it and the wall or hard place.

There is an excessive amount of foam in the drawer for washing detergent.	You have used a wrong amount of washing detergent.	Press the Start/Pause button. You can prevent foam from forming by pouring a mixture of half a spoon of fabric softener and half a litre of water into the washing detergent drawer. Press the Start/Pause button again after 5-10 minutes. When you wash again, use the correct amount of washing detergent.
	Unsuitable washing detergent.	Only use washing detergents specially made for automatic washing machines.
Unsatisfactory wash result.	The degree to which your laundry is soiled does not correspond to the program you selected.	Select a program appropriate for the given degree to which your laundry is soiled. (More information in the program chart.)
	Insufficient amount of washing detergent.	Use an amount of washing detergent that corresponds to the level of soiling.
	You exceeded the maximum recommended laundry load in the drum.	The laundry load in the washing machine should not exceed the maximum capacity of the washing machine.
The water is drained out of the washing machine immediately after it has been filled.	The end of the drain hose is too low relative to the washing machine.	Locate the drain hose at an appropriate height. (***)
No water can be seen in the drum during the wash.	This is not a malfunction. Water is in a part of the drum that is not visible.	
There are washing detergent residues on the laundry.	Residues of the washing detergent in the form of white stains may appear on the laundry.	Set your washing machine to start the addition rinse program or remove the stains using a brush after the laundry has dried.
There are washing detergent residues on the laundry.	These stains may be caused by oil, a cream or a lotion.	During the next wash use the maximum amount of washing detergent set by its manufacturer.
Spinning does not take place or it occurs with a delay.	This is not a malfunction. The uneven contents testing system was activated.	The uneven load testing system may be trying to evenly arrange the laundry in the drum. The spinning process will commence as soon as the laundry is arranged evenly. Next time you wash, arrange the laundry evenly inside the drum.



(*) See page 18.

(**) See page 4.

(***) See page 6.

PART 9: AUTOMATIC MALFUNCTION DETECTION SYSTEM

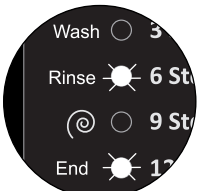
Your washing machine is equipped with a system, which during the washing process continually monitors the correct progress and in the case of any malfunction takes the necessary remedy measures and will at the same time inform you about the malfunction.

Error code	Possible cause	Solution
E01 	Open washing machine door.	Close the washing machine door. If the problem continues, turn off the washing machine, disconnect it from the power socket and immediately contact the nearest authorised service centre.
E02 	The pump is damaged, the pump filter is clogged or the pump electronics are not working.	Clean out the pump filter. If the problem persists, contact your nearest authorised service centre.
E03 	Low water pressure or there is not enough water in the drum of the washing machine.	Clean out the pump filter. If the problem persists, contact your nearest authorised service centre. (*)
E04 	There is an excessive amount of water in the washing machine.	Close the door. If the problem persists, contact your nearest authorised service centre.

(*) Check the information contained in chapter "MAINTENANCE AND CLEANING".

PART 10: INFORMATION SHEET

Information Sheet
INFORMATION SHEET: Philco

Philco brand: **PHILCO** 

Brand	Philco
Product number	PL 151 F
Washing capacity (kg) - cotton 60°C	5
Energy efficiency class (A... low electricity consumption to G high electricity consumption) for washing, spinning, drying per single cycle	A+
Annual power consumption (kWh) cotton - 60°C *	167
Power consumption (kWh) - 60°C/cycle	0.85
Annual water consumption (l) - washing, drying - cotton 60°C *	9240
Spinning class	C
Maximum rpm (washing)	1000
Duration of the standard program - cotton 60°/40° (min)	190/140
Noise level dB (re 1pW) ** - washing	58
Application	free standing
Noise level dB (re 1pW) ** - spinning	77
Dimensions cm (h x w x d) cm	84.5x59.7x49.7
Weight kg	60.5

The standard program for washing cotton at 60°C is the standard washing program, to which the information contained on the rating label relates. This program is suitable for washing standard soiled cotton laundry and is the most effective program in respect to the combined water and power consumption.

* The annual water and power consumption based on 220 standard wash cycles using the program for cotton at 60°C

** Noise level according to European norm EN 60704

NOTE:

All the here mentioned data is subject to change.

INSTRUCTIONS AND INFORMATION REGARDING THE DISPOSAL OF USED PACKAGING MATERIALS

Dispose of packaging material at a public waste disposal site.

DISPOSAL OF USED ELECTRICAL AND ELECTRONIC APPLIANCES



The meaning of the symbol on the product, its accessory or packaging indicates that this product shall not be treated as household waste. Please, dispose of this product at your applicable collection point for the recycling of electrical & electronic equipment waste. Alternatively in some states of the European Union or other European states you may return your products to your local retailer when buying an equivalent new product. The correct disposal of this product will help save valuable natural resources and help in preventing the potential negative impact on the environment and human health, which could be caused as a result of improper liquidation of waste. Please ask your local authorities or the nearest waste collection centre for further details. The improper disposal of this type of waste may fall subject to national regulations for fines.

For business entities in the European Union

If you wish to dispose of an electrical or electronic device, request the necessary information from your seller or supplier.

Disposal in other countries outside the European Union

If you wish to dispose of this product, request the necessary information about the correct disposal method from local government departments or from your seller.



This product meets all the basic EU regulation requirements that relate to it.

Changes to the text, design and technical specifications may occur without prior notice and we reserve the right to make these changes.