

RANGE HOOD

OWNER'S MANUAL

PHILCO



Famous for Quality the World Over

PEW 626 Wave

**Dear customer,
Thank you for buying a PHILCO brand product. So that your appliance serves you well, please read all the instructions in this user's manual.**

CONTENTS

PART 1: IMPORTANT SAFETY INSTRUCTIONS.....	2
Cautions.....	2
Lamp.....	4
PART 2: DESCRIPTION OF THE APPLIANCE	5
PART 3: INSTALLATION	6
Use.....	6
Electrical connection	7
Mounting	7
Installation Step.....	8
PART 4: OPERATION.....	11
Electronic Switch.....	11
PART 5: MAINTENANCE AND CLEANING.....	12
PART 6: BEFORE YOU CALL THE SERVICE CENTRE	13

PART 1: IMPORTANT SAFETY INSTRUCTIONS

Closely follow the instructions set out in this manual. All responsibility, for any eventual inconveniences, damages or fires caused by not complying with the instructions in this manual, is declined. The hood is conceived for the suction of cooking fumes and steam and is destined only for domestic use.

- ! It is important to conserve this booklet for consultation at any moment. In the case of sale, cession or move, make sure it is together with the product.
- ! Read the instructions carefully: there is important information about installation, use and safety.
- ! Do not carry out electrical or mechanical variations on the product or on the discharge conduits.
- ! Before proceeding with the installation of the appliance verify that there are no damaged all components. Otherwise contact your dealer and do not proceed with the installation.

Note: the elements marked with the symbol "(*)" are optional accessories supplied only with some models or elements to purchase, not supplied.



Cautions

Before any cleaning or maintenance operation, disconnect hood from the mains by removing the plug or disconnecting the mains electrical supply.

Always wear work gloves for all installation and maintenance operations.

This appliance can be used by children aged from 8 years and above and persons with reduced physical, sensory or mental capabilities or lack of experience and knowledge if they have been given supervision or instruction concerning use of the appliance in a safe way and understand the hazards involved.

Children shall not be allowed to tamper with the controls or play with the appliance.

Cleaning and user maintenance shall not be made by children without supervision.

The premises where the appliance is installed must be sufficiently ventilated, when the kitchen hood is used together with other gas combustion devices or other fuels.

The hood must be regularly cleaned on both the inside and outside (at least once a month).

This must be completed in accordance with the maintenance instructions provided in this manual. Failure to follow the instructions provided in this user guide regarding the cleaning of the hood and filters will lead to the risk of fires. The flaming of foods beneath the hood itself is severely prohibited.

The use of exposed flames is detrimental to the filters and may cause a fire risk, and must therefore be avoided in all circumstances.

Any frying must be done with care in order to make sure that the oil does not overheat and ignite.

CAUTION: Accessible parts of the hood may become hot when used with cooking appliances.

For lamp replacement use only lamp type indicated in the Maintenance/Replacing lamps section of this manual.

WARNING! Do not connect the appliance to the mains until the installation is fully complete.

With regards to the technical and safety measures to be adopted for fume discharging it is important to closely follow the regulations provided by the local authorities.

The ducting system for this appliance must not be connected to any existing ventilation system which is being used for any other purpose such as discharging exhaust fumes from appliances burning gas or other fuels.

Do not use or leave the hood without the lamp correctly mounted due to the possible risk of electric shocks.

Never use the hood without effectively mounted grids.

The hood must NEVER be used as a support surface unless specifically indicated.

Use only the fixing screws supplied with the product for installation or, if not supplied, purchase the correct screws type.

Use the correct length for the screws which are identified in the Installation Guide.

In case of doubt, consult an authorised service assistance centre or similar qualified person.

This appliance is marked according to the European directive 2012/19/EC on Waste Electrical and Electronic Equipment (WEEE). By ensuring this product is disposed of correctly, you will help prevent potential negative consequences for the environment and human health, which could otherwise be caused by inappropriate waste handling of this product.



The symbol  on the product, or on the documents accompanying the product, indicates that this appliance may not be treated as household waste. Instead it should be taken to the appropriate collection point for the recycling of electrical and electronic equipment. Disposal must be carried out in accordance with local environmental regulations for waste disposal.

For further detailed information regarding the process, collection and recycling of this product, please contact the appropriate department of your local authorities or the local department for household waste or the shop where you purchased this product.

Appliance designed, tested and manufactured according to:

- Safety: EN 60335-1; EN 60335-2-31, EN 62233.
- Performance: EN 61591; EN 60704-1; EN 60704-2-13; EN 50564
- EMC: EN 55014-1; EN 55014-2; EN 61000-3-2; EN 61000-3-3.

Suggestions for a correct use in order to reduce the environmental impact: Switch ON the hood at minimum speed when you start cooking and kept it running for few minutes after cooking is finished. Increase the speed only in case of large amount of smoke and vapour and use boost speed(s) only in extreme situations. Replace the charcoal filter(s) when necessary to maintain a good odour reduction efficiency. Clean the grease filter(s) when necessary to maintain a good grease filter efficiency. Use the maximum diameter of the ducting system indicated in this manual to optimize efficiency and minimize noise.

Lamp

The available lamps and the correspondence ILCOS D codes and lamp pictures:

Use type lamp (or use in alternative type lamp) DSS-1.5-S-60 (ILCOS D code in according to standard IEC61231). -

Self-ballasted fluorescent reflector lamp – Integral induction type ballast

- Max wattage: 1.5W
- Voltage range: 12V
- Dimensions: diameter 60mm

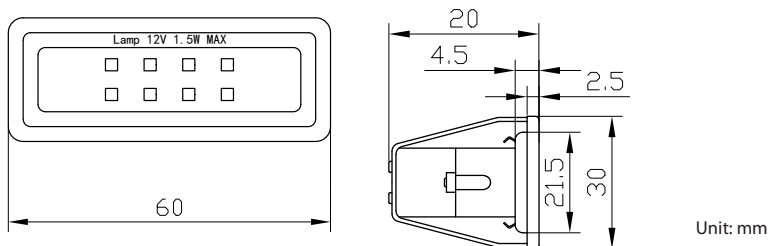

We recommend that you contact the authorized PHILCO service center to replace the LED lighting.

PART 2: DESCRIPTION OF THE APPLIANCE

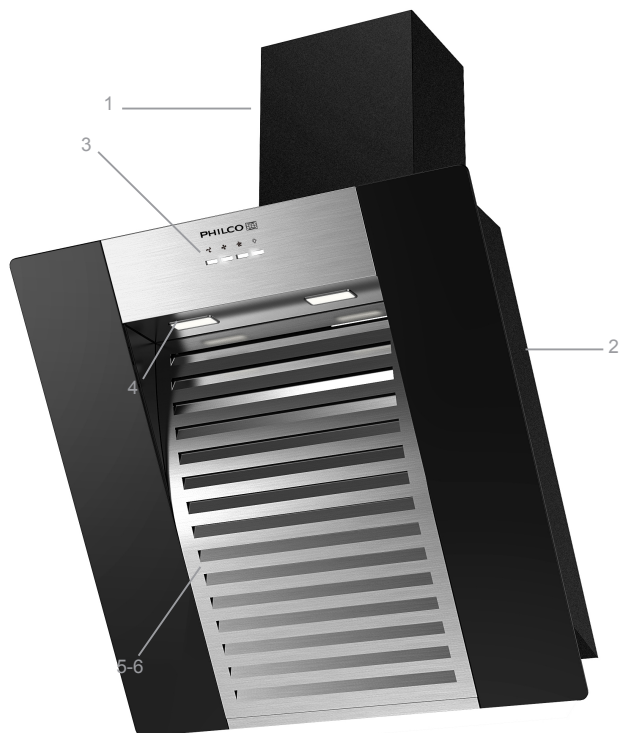

1. Chimney
2. Casing
3. Electronic Switch
4. LED Lamp
5. Grease filter
6. Motor

PART 3: INSTALLATION

Use

The hood is designed to be used either for exhausting or filter version.

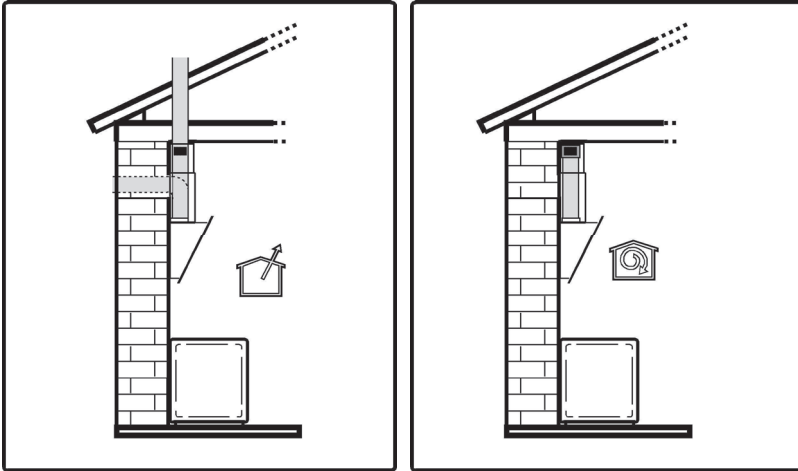

Ducting version

In this case the fumes are conveyed outside of the building by means of a special pipe connected with the connection ring located on top of the hood.

Attention! The exhausting pipe is supplied.

Diameter of the exhausting pipe must be equal to that of the connection ring.

Attention! The charcoal filter is not supplied. If the hood is supplied with active charcoal filter, then it must be removed.

Connect the hood and discharge holes on the walls with a diameter equivalent to the air outlet (connection flange).

Using the tubes and discharge holes on walls with smaller dimensions will cause a diminution of the suction performance and a drastic increase in noise.

Any responsibility in the matter is therefore declined.

! Use a duct of the minimum indispensable length.

! Use a duct with as few elbows as possible (maximum elbow angle: 90°).

! Avoid drastic changes in the duct cross-section.



Filter version

The aspirated air will be degreased and deodorised before being fed back into the room.

In order to use the hood in this version, you have to install a system of additional filtering based on activated charcoal.

Attention! The charcoal filter is not supplied and must be purchased apart.

Electrical connection

The mains power supply must correspond to the rating indicated on the plate situated inside the hood. If provided with a plug connect the hood to a socket in compliance with current regulations and positioned in an accessible area, after installation. If it not fitted with a plug (direct mains connection) or if the plug is not located in an accessible area, after installation, apply a double pole switch in accordance with standards which assures the complete disconnection of the mains under conditions relating to over-current category III, in accordance with installation instructions.

Warning! Before re-connecting the hood circuit to the mains supply and checking the efficient function, always check that the mains cable is correctly assembled.

The hood is provided with a special power cable ; if the cable is damaged, request a new one from Technical Service.

Mounting

Before beginning installation:

- Check that the product purchased is of a suitable size for the chosen installation area.
- Remove the charcoal filter/s if supplied. This/these is/are to be mounted only if you want to use the hood in the filtering version.
- Check (for transport reasons) that there is no other supplied material inside the hood (e.g. packets with screws, owner's manual, etc.), eventually removing them and keeping them.
- Remove the tape on the vent.
- Turn the unit off and unplug it from the outlet.

In the case of the presence of panels and/or walls and/or lateral wall units check that there is sufficient space to install the hood and that access to the command panel is easy.

Expansion wall plugs are provided to secure the hood to most types of walls/ceilings. However, a qualified technician must verify suitability of the materials in accordance with the type of wall/ceiling. The wall/ceiling must be strong enough to take the weight of the hood. **Do not tile, grout or silicone this appliance to the wall. Surface mounting only.**

The minimum distance between the supporting surface for the cooking equipment on the hob and the lowest part of the range hood must be not less than 45cm from electric cookers and 55cm from gas or mixed cookers. If the instructions for installation for the gas hob specify a greater distance, this must be adhered to.

Only for some models

An aesthetic flue can be purchased as an optional accessory. Check with the authorized dealer whether the model in your possession envisages this possibility.

We advise installing the hood after having purchased the flue to check with certainty the most suitable installation.

Installation Step

- The cooker hood should be installed so that there is a space of 650-760mm from the centre of the mesh grease filters to the hob (450-550mm from the bottom of the hood to the hob). It is the manufacturer of the hob who determines the clearance required and the clearance quoted by the hob manufacturer must be followed. In the absence of any instructions supplied with a gas hob the minimum distance between the hob and the hood must be at least 760mm.

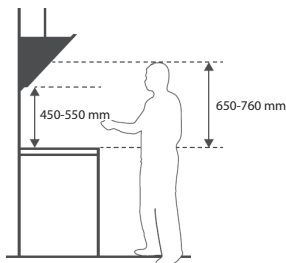

- Double check the tape on the vent has been removed.

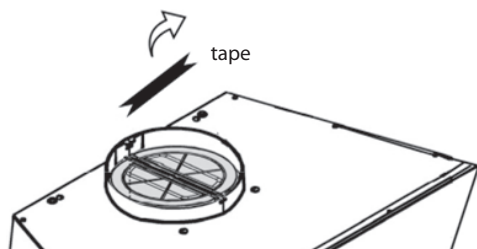

- Drill 3 × 8 mm holes for hood holding bracket. Tighten the bracket with the screws and plugs provided.

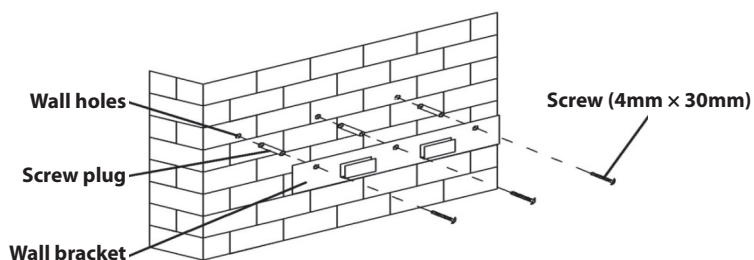

- Lift the hood up and hang it onto the wall bracket.

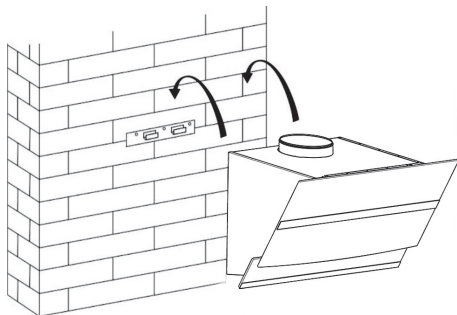

- Open the glass panel and remove the grease filter. Mark the two holes for the security screws from hood inside. Take the hood off again. Drill the two $\varnothing 8\text{mm}$ holes at the marked locations. Insert 2 wall plugs into the holes. Hang the hood back on the wall bracket and tighten 2 security screws from inside.

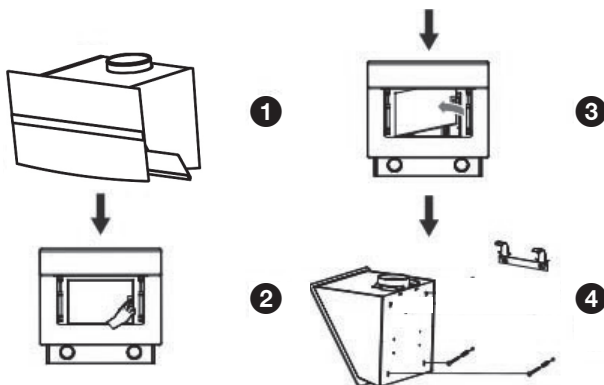

- The $\varnothing 150\text{-}\varnothing 153\text{mm}$ exhausting pipe is supplied. When you choose the ducting version, place the exhausting pipe ($\varnothing 150\text{-}\varnothing 153\text{mm}$) on the hood. The head $\varnothing 153\text{mm}$ would connect to the hood. If you need to use the $\varnothing 120\text{-}\varnothing 123\text{mm}$ pipe, you can place the adapter (not supplied) firstly. When you choose the filter version, no need the exhausting pipe.

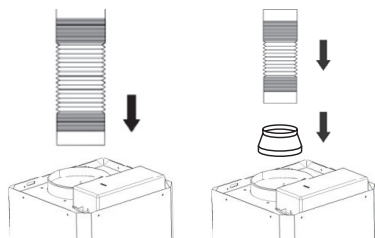

- The lower chimney bracket is used to fix the upper chimney and lower chimney. Use 2 pcs 4x8mm screws to attach lower and upper chimney.
 Noted: Do not fasten screws too strongly, make sure that the upper chimney can be telescopically adjusted after assembling.

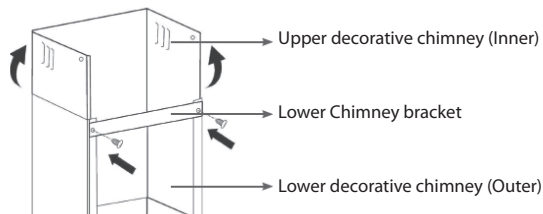

- Put the chimney on the cooker hood. Fix the lower chimney bracket on the wall by 2 screws (4x30mm).

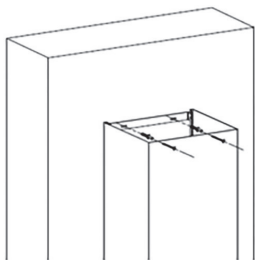

- Fix the upper chimney bracket on the upper chimney by 2 screws (4x8mm). Pull the upper chimney upwards to the desired height.
 Screw the upper chimney bracket on the wall by 2 screws (4x30mm).
 Fasten the lower chimney to the cooker hood with 2 screws (4x8mm).

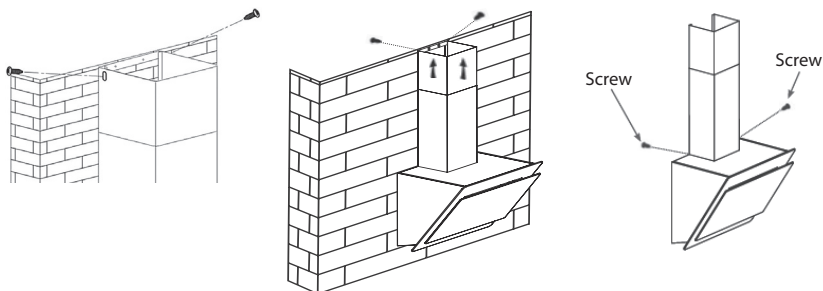

For safety reasons, use only the same size of fixing or mounting screws that are recommended in this instruction manual.

Failure to install the screws or fixing devices in accordance with these instructions may result in electrical hazards.

PART 4: OPERATION

Electronic Switch



Low Speed button

It is suitable for simmering and cooking which does not produce much steam or odour.



Medium Speed button

Airflow speed is ideal for extracting with standard cooking.



High Speed button

When a high amount of steam or odours are produced, use the high speed setting for the most effective extraction.



Light button

Switches the light on and off.

PART 5: MAINTENANCE AND CLEANING

Regarding the replacement of the bulb, cleaning and maintenance of the appliance, please refer to below paragraphs of this manual.

Attention!

Before cleaning, switch the unit off and pull out the plug.

I. Regular Cleaning

Use a soft cloth moistened with hand-warm mild soap water or household cleaning detergent. Never use metal pads, chemical, abrasive material or a stiff brush to clean the unit.

II. Monthly Cleaning of the Grease Filter

ESSENTIAL: Clean the filter every month to prevent any risk of fire.

The filter collects grease, smoke and dust, so the filter is directly affecting the efficiency of the cooker hood. If not cleaned, the grease residue (potentially flammable) will saturate on the filter. Clean it with household cleaning detergent.

III. Charcoal filter (filter version only)

It absorbs unpleasant odours caused by cooking.

The saturation of the charcoal filter occurs after more or less prolonged use, depending on the type of cooking and the regularity of cleaning of the grease filter. In any case it is necessary to replace the cartridge at least every four months (or when the filter saturation indication system – if envisaged on the model in possession – indicates this necessity). The charcoal filter may NOT be washed or regenerated.

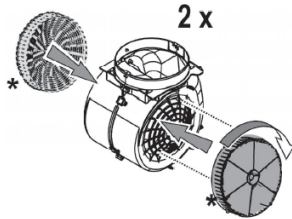

IV. Bulb Replacement

1. Switch the unit off and unplug the appliance.
2. Remove the filters.
3. Release the lamp connectors on top and push the lamp out from inside.
4. Replace with the same type of lamp.

PART 6: BEFORE YOU CALL THE SERVICE CENTRE

If the appliance is not working as it should check the following recommendations for resolving the most common problems.

If the problem persists or it is not included in the table below, turn off the appliance and disconnect it from the power socket and contact an authorised service centre.

Problem	Solution
The range hood is not working.	Check that the power plug is properly inserted in a properly grounded power socket with the parameters 220 – 240 V ~ 50 Hz.
	Check that the motor power switch is in the "On" position.
The lights are not working.	Check that the power plug is properly inserted in a properly grounded power socket with the parameters 220 – 240 V ~ 50 Hz.
	Check that the motor power switch is in the "On" position.
	Check whether the light bulb or fluorescent tube is broken.
Exhaust power is weak.	Check whether the aluminium filters are dirty.
	Check the air outlet, it should be open.
	Check whether the carbon filter is not too dirty.
The range hood does not extract the air directly out (for models without an exhaust).	Check whether the aluminium filters are dirty.
	Check whether the carbon filter is not too dirty.

ATTENTION:

Use the range hood together with the stove. This will ensure the correct air exhaust. We recommend to leave the range hood running a few minutes longer than the stove to ensure that all odours are extracted.

Technical drawings PEW 626 Wave

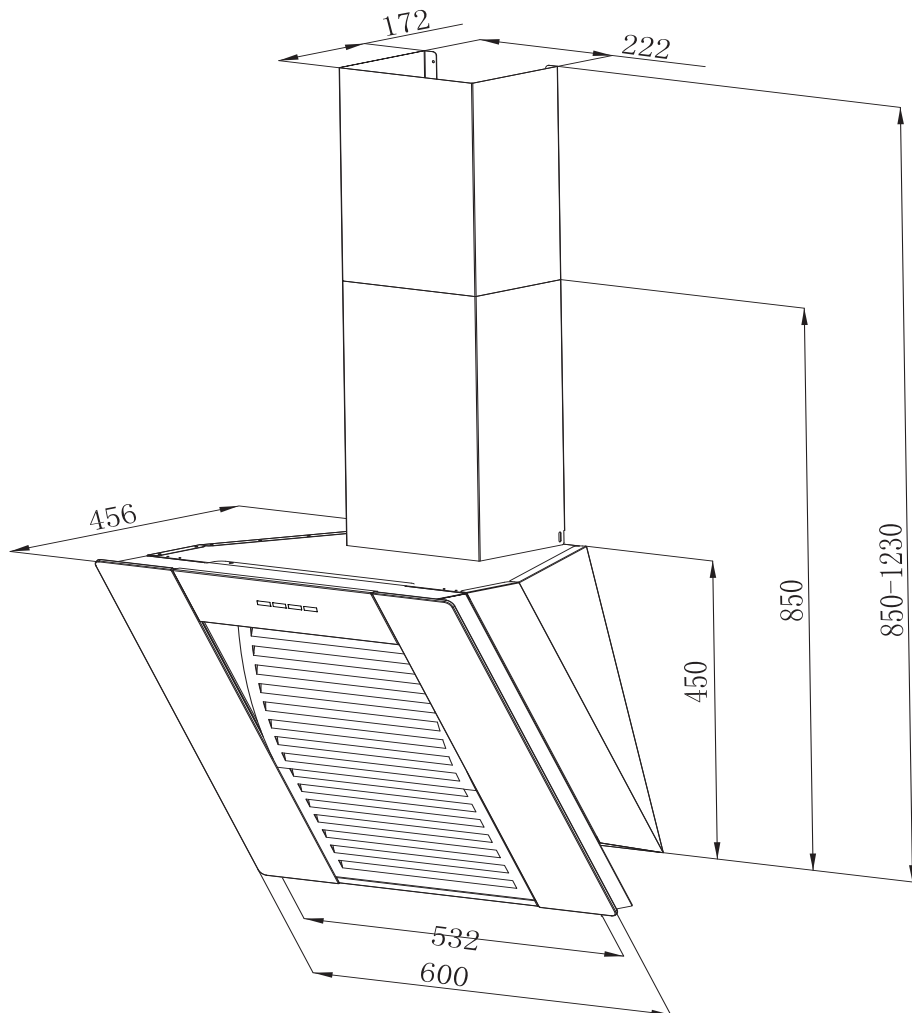

INSTRUCTIONS AND INFORMATION REGARDING THE DISPOSAL OF USED PACKAGING MATERIALS

Dispose of packaging material at a public waste disposal site.

DISPOSAL OF USED ELECTRICAL AND ELECTRONIC APPLIANCES



The meaning of the symbol on the product, its accessory or packaging indicates that this product shall not be treated as household waste. Please, dispose of this product at your applicable collection point for the recycling of electrical & electronic equipment waste. Alternatively in some states of the European Union or other European states you may return your products to your local retailer when buying an equivalent new product. The correct disposal of this product will help save valuable natural resources and help in preventing the potential negative impact on the environment and human health, which could be caused as a result of improper liquidation of waste. Please ask your local authorities or the nearest waste collection centre for further details. The improper disposal of this type of waste may fall subject to national regulations for fines.

For business entities in the European Union

If you wish to dispose of an electrical or electronic device, request the necessary information from your seller or supplier.

Disposal in other countries outside the European Union

If you wish to dispose of this product, request the necessary information about the correct disposal method from local government departments or from your seller.



This product meets all the basic EU regulation requirements that relate to it.

Changes to the text, design and technical specifications may occur without prior notice and we reserve the right to make these changes.

Manufacturer/Importer:
Fast ČR, a.s.
Praha 10, Černokostecká 2111
CZ-10000; CZECH REPUBLIC

PHILCO[®] 

**is a registered trademark used under license from
Electrolux Home Products., Inc.**