

RANGE HOOD

OWNER'S MANUAL

PHILCO



Famous for Quality the World Over

PEC 1905 W

PEC 1905 X

PEC 190 W

PEC 190 X

PEC 350 WR

PEC 350 XR

**Dear customer,
Thank you for buying a PHILCO brand product. So that your appliance serves you well, please read all the instructions in this user's manual.**

CONTENTS

| | |
|---|-----------|
| PART 1: IMPORTANT SAFETY INSTRUCTIONS..... | 2 |
| Cautions..... | 2 |
| Lamp..... | 4 |
| PART 2: DESCRIPTION OF THE APPLIANCE | 5 |
| PART 3: INSTALLATION | 6 |
| Use..... | 6 |
| Electrical connection | 7 |
| Mounting | 7 |
| Installation Step..... | 8 |
| PART 4: OPERATION..... | 12 |
| Push button..... | 12 |
| PART 5: MAINTENANCE AND CLEANING..... | 13 |
| PART 6: BEFORE YOU CALL THE SERVICE CENTRE | 14 |

PART 1: IMPORTANT SAFETY INSTRUCTIONS

Closely follow the instructions set out in this manual. All responsibility, for any eventual inconveniences, damages or fires caused by not complying with the instructions in this manual, is declined. The hood is conceived for the suction of cooking fumes and steam and is destined only for domestic use.

- ! It is important to conserve this booklet for consultation at any moment. In the case of sale, cession or move, make sure it is together with the product.
- ! Read the instructions carefully: there is important information about installation, use and safety.
- ! Do not carry out electrical or mechanical variations on the product or on the discharge conduits.
- ! Before proceeding with the installation of the appliance verify that there are no damaged all components. Otherwise contact your dealer and do not proceed with the installation.

Note: the elements marked with the symbol "(*)" are optional accessories supplied only with some models or elements to purchase, not supplied.



Cautions

Before any cleaning or maintenance operation, disconnect hood from the mains by removing the plug or disconnecting the mains electrical supply.

Always wear work gloves for all installation and maintenance operations.

This appliance can be used by children aged from 8 years and above and persons with reduced physical, sensory or mental capabilities or lack of experience and knowledge if they have been given supervision or instruction concerning use of the appliance in a safe way and understand the hazards involved.

Children shall not be allowed to tamper with the controls or play with the appliance.

Cleaning and user maintenance shall not be made by children without supervision.

The premises where the appliance is installed must be sufficiently ventilated, when the kitchen hood is used together with other gas combustion devices or other fuels.

The hood must be regularly cleaned on both the inside and outside (at least once a month).

This must be completed in accordance with the maintenance instructions provided in this manual. Failure to follow the instructions provided in this user guide regarding the cleaning of the hood and filters will lead to the risk of fires. The flaming of foods beneath the hood itself is severely prohibited.

The use of exposed flames is detrimental to the filters and may cause a fire risk, and must therefore be avoided in all circumstances.

Any frying must be done with care in order to make sure that the oil does not overheat and ignite.

CAUTION: Accessible parts of the hood may become hot when used with cooking appliances.

For lamp replacement use only lamp type indicated in the Maintenance/Replacing lamps section of this manual.

WARNING! Do not connect the appliance to the mains until the installation is fully complete.

With regards to the technical and safety measures to be adopted for fume discharging it is important to closely follow the regulations provided by the local authorities.

The ducting system for this appliance must not be connected to any existing ventilation system which is being used for any other purpose such as discharging exhaust fumes from appliances burning gas or other fuels.

Do not use or leave the hood without the lamp correctly mounted due to the possible risk of electric shocks.

Never use the hood without effectively mounted grids.

The hood must NEVER be used as a support surface unless specifically indicated.

Use only the fixing screws supplied with the product for installation or, if not supplied, purchase the correct screws type.

Use the correct length for the screws which are identified in the Installation Guide.

In case of doubt, consult an authorised service assistance centre or similar qualified person.

This appliance is marked according to the European directive 2012/19/EC on Waste Electrical and Electronic Equipment (WEEE). By ensuring this product is disposed of correctly, you will help prevent potential negative consequences for the environment and human health, which could otherwise be caused by inappropriate waste handling of this product.



The symbol  on the product, or on the documents accompanying the product, indicates that this appliance may not be treated as household waste. Instead it should be taken to the appropriate collection point for the recycling of electrical and electronic equipment. Disposal must be carried out in accordance with local environmental regulations for waste disposal.

For further detailed information regarding the process, collection and recycling of this product, please contact the appropriate department of your local authorities or the local department for household waste or the shop where you purchased this product.

Suggestions for a correct use in order to reduce the environmental impact: Switch ON the hood at minimum speed when you start cooking and kept it running for few minutes after cooking is finished. Increase the speed only in case of large amount of smoke and vapour and use boost speed(s) only in extreme situations. Replace the charcoal filters when necessary to maintain a good odour reduction efficiency. Clean the grease filter when necessary to maintain a good grease filter efficiency. Use the maximum diameter of the ducting system indicated in this manual to optimize efficiency and minimize noise.

Lamp

The available lamps and the correspondence ILCOS D codes and lamp pictures:

Use type lamp (or use in alternative type lamp) DSS-2-S-120 (ILCOS D code in according to standard IEC61231).

- Self-ballasted fl uorescent refl ector lamp – Integral induction type ballast
- Max wattage: 2 W
- Voltage range: 220-240V~50Hz
- Dimensions: diameter 120mm

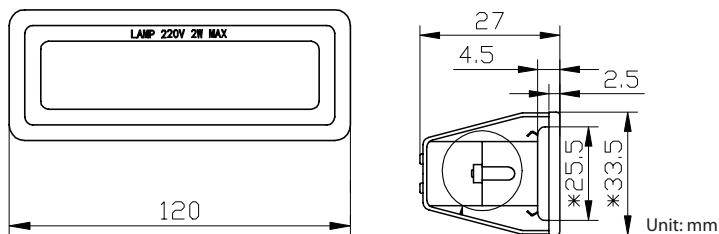

The available lamps and the correspondence ILCOS D codes and lamp pictures:

Use type lamp (or use in alternative type lamp) DRB-2-H-E14-100 (ILCOS D code in according to standard IEC61231).

- Self-ballasted fl uorescent refl ector lamp – Integral type ballast
- Max wattage: 2 W
- Voltage range: 220-240V~50Hz
- Dimensions: diameter 100mm

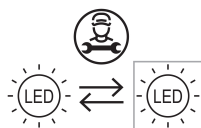
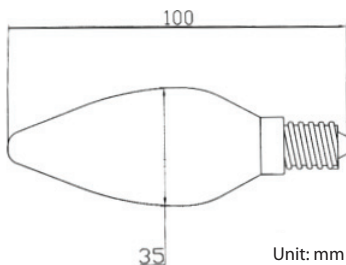

This appliance contains an LED light source which must be replaced by a service person.

PART 2: DESCRIPTION OF THE APPLIANCE



1. Casing
2. Push button control
3. LED Bulb / LED Lamp
4. Grease filter
5. Motor

PART 3: INSTALLATION

Use

The hood is designed to be used either for exhausting or filter version.

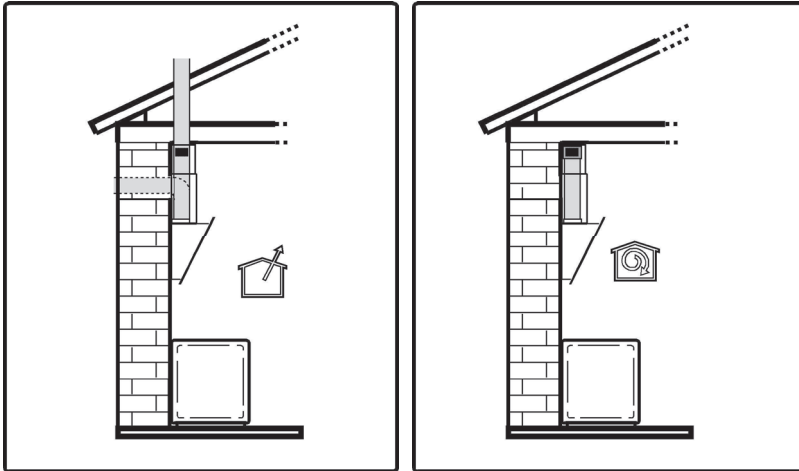

Ducting version

In this case the fumes are conveyed outside of the building by means of a special pipe connected with the connection ring located on top of the hood.

Attention! The exhausting pipe is not supplied.

Diameter of the exhausting pipe must be equal to that of the connection ring.

Attention! The charcoal filter is not supplied. If the hood is supplied with active charcoal filter, then it must be removed.

Connect the hood and discharge holes on the walls with a diameter equivalent to the air outlet (connection flange).

Using the tubes and discharge holes on walls with smaller dimensions will cause a diminution of the suction performance and a drastic increase in noise.

Any responsibility in the matter is therefore declined.

! Use a duct of the minimum indispensable length.

! Use a duct with as few elbows as possible (maximum elbow angle: 90°).

! Avoid drastic changes in the duct cross-section.



Filter version

The aspirated air will be degreased and deodorised before being fed back into the room.

In order to use the hood in this version, you have to install a system of additional filtering based on activated charcoal.

Attention! The charcoal filter is not supplied and must be purchased apart.

Electrical connection

The mains power supply must correspond to the rating indicated on the plate situated inside the hood. If provided with a plug connect the hood to a socket in compliance with current regulations and positioned in an accessible area, after installation. If it not fitted with a plug (direct mains connection) or if the plug is not located in an accessible area, after installation, apply a double pole switch in accordance with standards which assures the complete disconnection of the mains under conditions relating to over-current category III, in accordance with installation instructions.

Warning! Before re-connecting the hood circuit to the mains supply and checking the efficient function, always check that the mains cable is correctly assembled.

The hood is provided with a special power cable ; if the cable is damaged, request a new one from Technical Service.

Mounting

Before beginning installation:

- Check that the product purchased is of a suitable size for the chosen installation area.
- Remove the charcoal filter/s if supplied. This/these is/are to be mounted only if you want to use the hood in the filtering version.
- Check (for transport reasons) that there is no other supplied material inside the hood (e.g. packets with screws, owner's manual, etc.), eventually removing them and keeping them.
- Remove the tape on the vent.
- Turn the unit off and unplug it from the outlet.

In the case of the presence of panels and/or walls and/or lateral wall units check that there is sufficient space to install the hood and that access to the command panel is easy.

Expansion wall plugs are provided to secure the hood to most types of walls/ceilings. However, a qualified technician must verify suitability of the materials in accordance with the type of wall/ceiling. The wall/ceiling must be strong enough to take the weight of the hood. **Do not tile, grout or silicone this appliance to the wall. Surface mounting only.**

The minimum distance between the supporting surface for the cooking equipment on the hob and the lowest part of the range hood must be not less than 45cm from electric cookers and 55cm from gas or mixed cookers. If the instructions for installation for the gas hob specify a greater distance, this must be adhered to.

Only for some models

An aesthetic flue can be purchased as an optional accessory. Check with the authorized dealer whether the model in your possession envisages this possibility.

We advise installing the hood after having purchased the flue to check with certainty the most suitable installation.

Installation Step

- The cooker hood should be installed so that there is a space of 650-750mm from the centre of the mesh grease filters to the hob. It is the manufacturer of the hob who determines the clearance required and the clearance quoted by the hob manufacturer must be followed. In the absence of any instructions supplied with a gas hob the minimum distance between the hob and the hood must be at least 760mm.

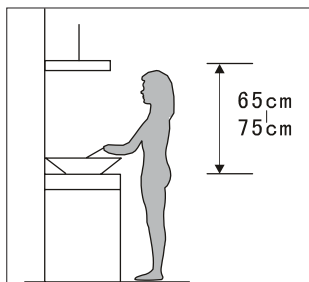

- Double check the tape on the vent has been removed.

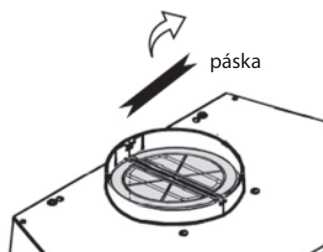

There are 2 ways to install this cooker hood: For wall installation & for cabinet installation.

Wall installation:

- To install onto the wall drill two Ø8mm holes in a suitable place according with the centre distance of the holes in the back of the cooker hood.
- Insert the wall plugs into the holes.
- Insert the screws into the wall plugs and tighten. Place the cooker hood onto the tightened screws.
- Put the one way valve onto the cooker hood.

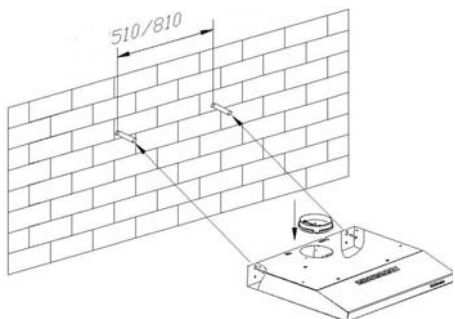

- Fix the cooker hood with the safety screws. The two holes are positioned on the back casing, with diameter of 6mm.

Cabinet installation:

- Drill 4 holes of 6mm diameter at the bottom of the hanging cupboard.
- Fix the one way valve to the cooker hood, then install the cooker hood on the bottom of the hanging cupboard, tighten the hood with the enclosed 4 screws.

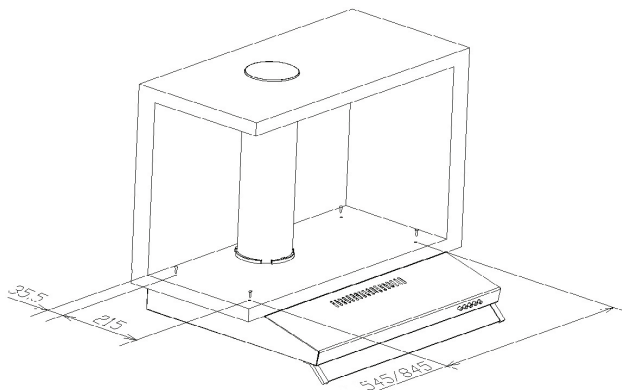

Noted: The ducting is an optional accessory, it is not supplied.

1. The ducting tube is not supplied with the extractor.
2. Take off the protective film before installation.
3. There are 2 methods for ducting , including , rear ventilation' and , vertical ventilation': Please pay attention to the ventilation method when installing. Vertical ventilation: See Pic A, please use a tool take out the round cover before using, the air can now be vented from top.

Rear ventilation: See Pic B, please use a tool to remove the rectangular cover before using, the air can now be vented from back.

The rectangular air outlet for horizontal ventilation is not supplied.

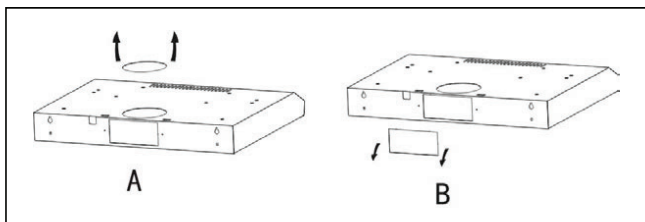

For safety reasons, use only the same size of fixing or mounting screws that are recommended in this instruction manual.

Failure to install the screws or fixing devices in accordance with these instructions may result in electrical hazards.

Air extraction setting:

- Ducting installation: Turn the adjuster to the ducted position, install the outlet, turn on the cooker hood. The air will be extracted to the outside outlet.

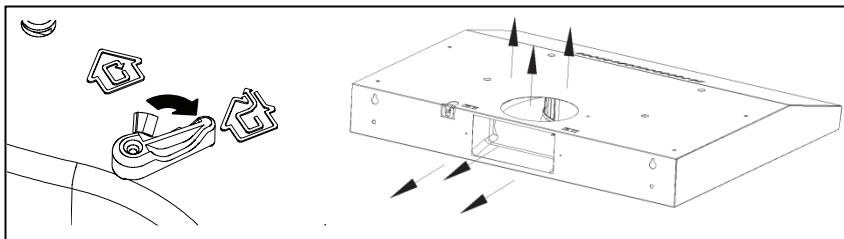

- Recirculation: the recirculation mode used a charcoal filter. Turn the adjuster to the indoor position, install the outlet cover, turn on the cooker hood, then the air can be vented from the inside outlet.

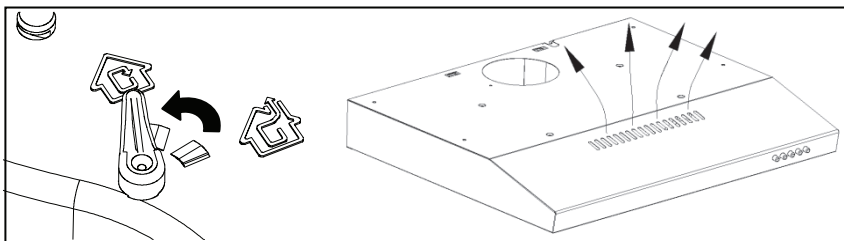

PART 4: OPERATION

Push button

0 1 2 3 ✨

- 0 On/Off button**
It's used for turning on/off the fan.
Then you can change the speeds as per below. Press again to switch off.
- 1 Low Speed button**
It is suitable for simmering and cooking which does not produce much steam or odour.
- 2 Medium Speed button**
Airflow speed is ideal for extracting with standard cooking.
- 3 High Speed button**
When a high amount of steam or odours are produced, use the high speed setting for the most effective extraction.
- ✨ Light button**
Switches the light on and off.

PART 5: MAINTENANCE AND CLEANING

Regarding the replacement of the bulb, cleaning and maintenance of the appliance, please refer to below paragraphs of this manual.

Attention!

Before cleaning, switch the unit off and pull out the plug.

I. Regular Cleaning

Use a soft cloth moistened with hand-warm mild soap water or household cleaning detergent. Never use metal pads, chemical, abrasive material or a stiff brush to clean the unit.

II. Monthly Cleaning of the Grease Filter

ESSENTIAL: Clean the filter every month to prevent any risk of fire.

The filter collects grease, smoke and dust, so the filter is directly affecting the efficiency of the cooker hood. If not cleaned, the grease residue (potentially flammable) will saturate on the filter. Clean it with household cleaning detergent.

III. Charcoal filter (filter version only)

It absorbs unpleasant odours caused by cooking.

The saturation of the charcoal filter occurs after more or less prolonged use, depending on the type of cooking and the regularity of cleaning of the grease filter. In any case it is necessary to replace the cartridge at least every four months (or when the filter saturation indication system – if envisaged on the model in possession – indicates this necessity). The charcoal filter may NOT be washed or regenerated.

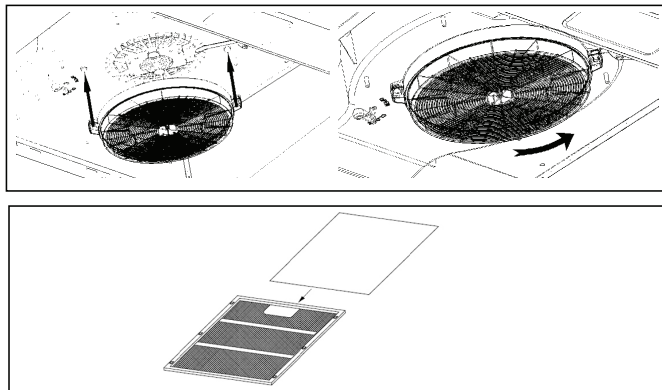

NOTE:

Make sure the filter is securely fitted. Otherwise, it could loosen and fall out. This could cause damage to the appliance and danger to the user. When the activated charcoal filter is used, the extraction rate will be lower.

IV. Bulb Replacement

1. Switch the unit off and unplug the appliance.
2. Remove the filters.
3. Release the lamp connectors and push the lamp out from inside.
4. Replace with the same type of lamp.

PART 6: BEFORE YOU CALL THE SERVICE CENTRE

If the appliance is not working as it should check the following recommendations for resolving the most common problems.

If the problem persists or it is not included in the table below, turn off the appliance and disconnect it from the power socket and contact an authorised service centre.

| Problem | Solution |
|---|---|
| The range hood is not working. | Check that the power plug is properly inserted in a properly grounded power socket with the parameters 220 – 240 V ~ 50 Hz. |
| | Check that the motor power switch is in the "On" position. |
| The lights are not working. | Check that the power plug is properly inserted in a properly grounded power socket with the parameters 220 – 240 V ~ 50 Hz. |
| | Check that the motor power switch is in the "On" position. |
| | Check whether the light bulb or fluorescent tube is broken. |
| Exhaust power is weak. | Check whether the aluminium filters are dirty. |
| | Check the air outlet, it should be open. |
| | Check whether the carbon filter is not too dirty. |
| The range hood does not extract the air directly out (for models without an exhaust). | Check whether the aluminium filters are dirty. |
| | Check whether the carbon filter is not too dirty. |

ATTENTION:

Use the range hood together with the stove. This will ensure the correct air exhaust. We recommend to leave the range hood running a few minutes longer than the stove to ensure that all odours are extracted.

Technical drawings **PEC 1905 W&PEC 1905 X**
PEC 190 W & PEC 190 X

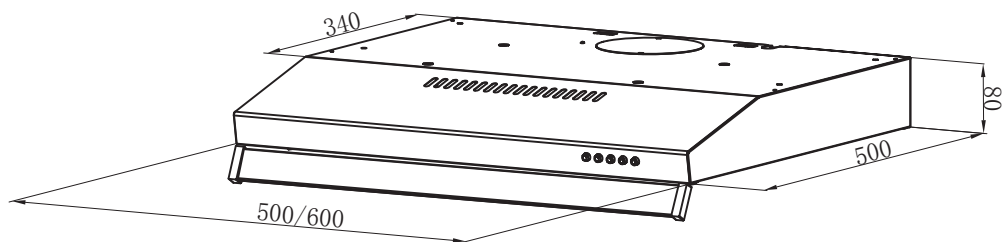

Technical drawings **PEC 350 WR & PEC 350 XR**

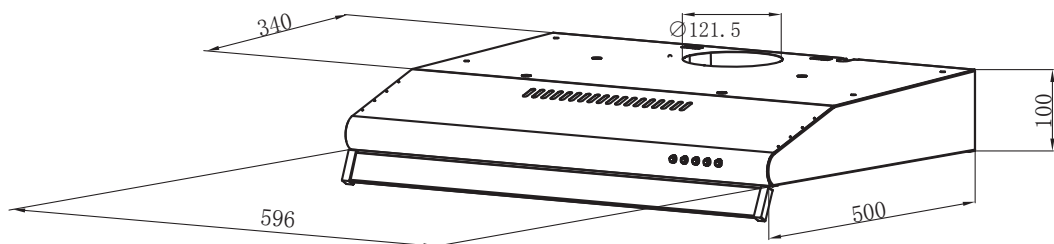

INSTRUCTIONS AND INFORMATION REGARDING THE DISPOSAL OF USED PACKAGING MATERIALS

Dispose of packaging material at a public waste disposal site.

DISPOSAL OF USED ELECTRICAL AND ELECTRONIC APPLIANCES



The meaning of the symbol on the product, its accessory or packaging indicates that this product shall not be treated as household waste. Please, dispose of this product at your applicable collection point for the recycling of electrical & electronic equipment waste. Alternatively in some states of the European Union or other European states you may return your products to your local retailer when buying an equivalent new product. The correct disposal of this product will help save valuable natural resources and help in preventing the potential negative impact on the environment and human health, which could be caused as a result of improper liquidation of waste. Please ask your local authorities or the nearest waste collection centre for further details. The improper disposal of this type of waste may fall subject to national regulations for fines.

For business entities in the European Union

If you wish to dispose of an electrical or electronic device, request the necessary information from your seller or supplier.

Disposal in other countries outside the European Union

If you wish to dispose of this product, request the necessary information about the correct disposal method from local government departments or from your seller.



This product meets all the basic EU regulation requirements that relate to it.

Changes to the text, design and technical specifications may occur without prior notice and we reserve the right to make these changes.

TECHNICAL INFORMATION

Technical information can be found on the type plate on the inside of the appliance and on the energy label. Keep the energy label, the instructions for use, together with other documents supplied with the device.

TESTING INFORMATION

The delivered device is in accordance with Ecodesign and EN 61591:1997 + A1:2006 + A2:2011 + A11:2014 + A12:2015 , EN 60704-1:2010+A11:2012, EN 60704-2-13:2011 , EN 50564:2011
If you have any further questions, please contact the manufacturer.

CUSTOMER CARE AND SERVICE

Always use original spare parts.

Model name and serial number can be found on the rating plate. Position of rating plate can be changed without notice.

The original spare parts for some specific components are available for a minimum of 7 or 10 years, based on the type of component, from the placing on the market of the last unit of the model.

When contacting our authorized service, have the model designation, serial number and defect description available.

To download documents, visit www.philco.cz.

To report a defect and obtain additional service information, visit <https://philco.cz/podpora-a-servis>.

Subject to change without notice.

Výrobce/Manufacturer:
Fast ČR, a.s.
U Sanitasu 1621
Říčany 251 01, CZECH REPUBLIC

Importer to SK:
FAST PLUS, a.s.
Na pántoch 18, 831 06 Bratislava
SLOVAKIA

PHILCO[®] 

is a pending or registered trademark of Electrolux Home Products, Inc. and used under a license from Electrolux Home Products, Inc.