

REFRIGERATOR

OWNER'S MANUAL

PHILCO



Famous for Quality the World Over

PTL 1302 W

**Dear customer,
Thank you for buying a PHILCO brand product. So that your appliance serves you well, please read all the instructions in this user's manual.**

CONTENTS

PART 1: SAFETY INFORMATION	3
PART 2: DESCRIPTION OF THE APPLIANCE	11
MAIN CONFIGURATION	11
PART 3: UNPACKING YOUR REFRIGERATOR	12
PART 4: CLEANING BEFORE USE	12
PART 5: SPACE REQUIREMENTS	12
PART 6: ELECTRICAL REQUIREMENT	13
RECOMMENDED EARTHING METHOD	13
PART 7: LEVELING	13
PART 8: USE OF THE APPLIANCE	14
TEMPERATURE CONTROL.....	14
FRESH FOOD STORAGE.....	14
DEFROSTING	14
CLEANING.....	15
PART 9: PROLONGED OFF PERIODS	15
PART 10: TROUBLESHOOTING	16
PART 11: REFRIGERATOR DOOR INSTALL GUIDELINES ABOUT SWAPPING LEFT&RIGHT	17
ENERGY SAVING TIPS	22
DAILY USE	22
STORAGE INSTRUCTIONS	23
PART 12: PRODUCT INFORMATION SHEET	25
TECHNICAL INFORMATION	27
TESTING INFORMATION.....	27
CUSTOMER CARE AND SERVICE.....	27
INSTRUCTIONS AND INFORMATION REGARDING THE DISPOSAL OF USED PACKAGING MATERIALS	28
DISPOSAL OF USED ELECTRICAL AND ELECTRONIC APPLIANCES	28



This appliance has been tested in accordance with the directives in force in the European Union.
This appliance conforms to the relevant safety provisions for electrical appliances in force in the European Union.

Dear customer:

Thank you for buying this refrigerator. To ensure that you get the best results from your new refrigerator, please take time to read through the simple instructions in this booklet.

Please ensure that the packing material is disposed of in accordance with the current environmental requirements.

When disposing of any refrigerator equipment please contact your local waste disposal department for advice on safe disposal.

This appliance must be only used for its intended purpose.

CAUTION:

The appliance is not intended for use by young children or infirm persons without supervision.

Young children should be supervised to ensure that they do not play with the appliance.

PART 1: Safety information



FOR YOUR SAFETY AND CORRECT USAGE, BEFORE INSTALLING AND FIRST USING THE APPLIANCE, READ THIS USER MANUAL CAREFULLY, INCLUDING ITS HINTS AND WARNINGS. TO AVOID UNNECESSARY MISTAKES AND ACCIDENTS, IT IS IMPORTANT TO MAKE SURE THAT ALL PEOPLE USING THE APPLIANCE ARE THOROUGHLY FAMILIAR WITH ITS OPERATION AND SAFETY FEATURES. SAVE THESE INSTRUCTIONS AND BE SURE THAT THEY REMAIN WITH THE APPLIANCE IF IT IS MOVED OR SOLD, SO THAT ANYONE USING IT THROUGHOUT ITS LIFE, WILL BE PROPERLY INFORMED ON ITS USAGE AND SAFETY NOTICES. FOR THE SAFETY OF LIFE AND PROPERTY, KEEP THE PRECAUTIONS OF THESE USER'S INSTRUCTIONS AS THE MANUFACTURER IS NOT RESPONSIBLE FOR DAMAGES CAUSED BY OMISSION.

- THIS APPLIANCE CAN BE USED BY CHILDREN AGED FROM 8 YEARS AND ABOVE AND PERSONS WITH REDUCED PHYSICAL, SENSORY OR MENTAL CAPABILITIES OR LACK OF EXPERIENCE AND KNOWLEDGE IF THEY HAVE BEEN GIVEN SUPERVISION OR INSTRUCTION CONCERNING USE OF THE APPLIANCE IN A SAFE WAY AND UNDERSTAND THE HAZARDS INVOLVED.
- CHILDREN AGED FROM 3 TO 8 YEARS ARE ALLOWED TO LOAD AND UNLOAD REFRIGERATING APPLIANCES.
- CHILDREN SHALL NOT PLAY WITH THE APPLIANCE.
- CLEANING AND USER MAINTENANCE CANNOT BE PERFORMED BY CHILDREN WITHOUT SUPERVISION.

● IF THE SUPPLY CABLE GETS DAMAGED, HAVE IT REPLACED BY A SPECIALIZED SERVICE CENTER IN ORDER TO AVOID DANGEROUS SITUATIONS. IT IS PROHIBITED TO USE THE APPLIANCE WHEN THE SUPPLY CABLE IS DAMAGED.

● **CAUTION:** IF YOUR MODEL IS EQUIPPED WITH AN ICE MAKER WITHOUT WATER SUPPLY CONNECTION, FILL IT WITH DRINKING WATER ONLY.

● **WARNING:** KEEP VENTILATION OPENINGS, IN THE APPLIANCE ENCLOSURE OR IN THE BUILT-IN STRUCTURE, CLEAR OF OBSTRUCTION.

● **WARNING:** DO NOT USE MECHANICAL DEVICES OR OTHER MEANS TO ACCELERATE THE DEFROSTING PROCESS, OTHER THAN THOSE RECOMMENDED BY THE MANUFACTURER.

● **WARNING:** DO NOT DAMAGE THE REFRIGERANT CIRCUIT.

● **WARNING:** DO NOT USE ELECTRICAL APPLIANCES INSIDE THE FOOD STORAGE COMPARTMENTS OF THE APPLIANCE, UNLESS THEY ARE OF THE TYPE RECOMMENDED BY THE MANUFACTURER.

● **WARNING:** DO NOT STORE EXPLOSIVE SUBSTANCES SUCH AS AEROSOL CANS WITH A FLAMMABLE PROPELLANT IN THIS APPLIANCE.

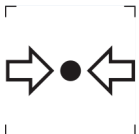

ISO 7000-1701 MARK (2004-01)
LABELS MEDIA UNDER PRESSURE..

THIS APPLIANCE IS INTENDED TO BE USED IN HOUSEHOLDS AND SIMILAR PREMISES, SUCH AS:

– KITCHENETTES IN SHOPS, OFFICES AND OTHER WORKPLACES; APPLIANCES USED BY GUESTS IN HOTELS, MOTELS, AND OTHER ACCOMMODATION FACILITIES; APPLIANCES USED IN BED-AND-BREAKFAST FACILITIES; APPLIANCES USED IN CATERING AND OTHER SIMILAR NON-VENDING ENVIRONMENTS.

ONLY SOME REFRIGERATOR MODELS ARE EQUIPPED WITH ICE MAKER. INTEGRATED ICE MAKERS MUST BE INSTALLED BY THE MANUFACTURER OR ITS SERVICING ORGANIZATION ONLY.

- THE FOLLOWING GOES FOR SELECTED MODELS EQUIPPED WITH AN ICE MAKER WITH WATER CONNECTION: **CAUTION:** CAN ONLY BE CONNECTED TO DRINKING WATER SUPPLY.

- **CAUTION:** THE APPLIANCE MUST BE FASTENED IN ACCORDANCE WITH THE MANUAL TO PREVENT DANGER CAUSED BY ITS INSTABILITY.

- **CAUTION:** THE COOLING SYSTEM CONTAINS REFRIGERANT UNDER HIGH PRESSURE. DO NOT MANIPULATE WITH THE SYSTEM. THE SYSTEM MAY BE REPAIRED BY AUTHORIZED PERSONS ONLY.



WARNING :
RISK OF FIRE / FLAMMABLE MATERIALS

CONTAINS COOLING GAS ISOBUTANE

R600a

REFRIGERANT

THE REFRIGERANT ISOBUTENE (R600a) IS CONTAINED WITHIN THE REFRIGERANT CIRCUIT OF THE APPLIANCE, A NATURAL GAS WITH A HIGH LEVEL OF ENVIRONMENTAL COMPATIBILITY, WHICH IS NEVERTHELESS FLAMMABLE. DURING TRANSPORTATION AND INSTALLATION OF THE APPLIANCE, ENSURE THAT NONE OF THE COMPONENTS OF THE REFRIGERANT CIRCUIT BECOMES DAMAGED. THE REFRIGERANT (R600a) IS FLAMMABLE.

● **WARNING** — REFRIGERATORS CONTAIN REFRIGERANT AND GASES IN THE INSULATION. REFRIGERANT AND GASES MUST BE DISPOSED OF PROFESSIONALLY AS THEY MAY CAUSE EYE INJURIES OR IGNITION. ENSURE THAT TUBING OF THE REFRIGERANT CIRCUIT IS NOT DAMAGE PRIOR TO PROPER DISPOSAL.



THE SYMBOL  IS A WARNING AND INDICATES THE REFRIGERANT AND INSULATION BLOWING GAS ARE FLAMMABLE.

WARNING : RISK OF FIRE / FLAMMABLE MATERIALS

IF THE REFRIGERANT CIRCUIT SHOULD BE DAMAGED:

- AVOID OPENING FLAMES AND SOURCES OF IGNITION.
- THOROUGHLY VENTILATE THE ROOM IN WHICH THE APPLIANCE IS SITUATED.

IT IS DANGEROUS TO ALTER THE SPECIFICATIONS OR MODIFY THIS PRODUCT IN ANY WAY.

ANY DAMAGE TO THE CORD MAY CAUSE A SHORT CIRCUIT, FIRE, AND/OR ELECTRIC SHOCK.

● **CAUTION:** THE COOLING SYSTEM CONTAINS REFRIGERANT UNDER HIGH PRESSURE. DO NOT MANIPULATE WITH THE SYSTEM.

THE SYSTEM MAY BE REPAIRED BY AUTHORIZED PERSONS ONLY.

● **CAUTION:** WHEN PLACING THE APPLIANCE IT MUST BE ENSURED THAT THE SUPPLY CORD DOES NOT GET CAUGHT OR DAMAGED.

● **CAUTION:** DO NOT PLACE PORTABLE MULTIPLE SOCKET-OUTLETS OR PORTABLE EXTENSION CABLES TO THE REAR SIDE OF THE APPLIANCE.



ELECTRICAL SAFETY

1. THE POWER CORD MUST NOT BE LENGTHENED.
2. MAKE SURE THAT THE POWER PLUG IS NOT CRUSHED OR DAMAGED.
A CRUSHED OR DAMAGED POWER PLUG MAY OVERHEAT AND CAUSE A FIRE.
3. MAKE SURE THAT YOU CAN ACCESS THE MAIN PLUG OF THE APPLIANCE.
4. DO NOT PULL THE MAIN CABLE.

5. IF THE POWER PLUG SOCKET IS LOOSE, DO NOT INSERT THE POWER PLUG. THERE IS A RISK OF ELECTRIC SHOCK OR FIRE.
6. YOU MUST NOT OPERATE THE APPLIANCE WITHOUT THE INTERIOR LIGHTING LAMP COVER.
7. THE FRIDGE IS ONLY APPLIED WITH POWER SUPPLY OF SINGLE PHASE ALTERNATING CURRENT OF 220-240V~/50Hz. IF FLUCTUATION OF VOLTAGE IN THE DISTRICT OF USER IS SO LARGE THAT THE VOLTAGE EXCEEDS THE ABOVE SCOPE, FOR SAFETY SAKE, BE SURE TO APPLY A.C. AUTOMATIC VOLTAGE REGULATOR OF MORE THAN 350W TO THE FRIDGE.

THE FRIDGE MUST EMPLOY A SPECIAL POWER SOCKET INSTEAD OF COMMON ONE WITH OTHER ELECTRIC APPLIANCES. ITS PLUG MUST MATCH THE SOCKET WITH GROUND WIRE.

DAILY USE

- DO NOT STORE FLAMMABLE GAS OR LIQUIDS IN THE APPLIANCE, THERE IS A RISK OF AN EXPLOSION.
- DO NOT OPERATE ANY ELECTRICAL APPLIANCES IN THE APPLIANCE (E.G. ELECTRIC ICE CREAM MAKERS, MIXERS ETC.).
- WHEN UNPLUGGING ALWAYS PULL THE PLUG FROM THE MAINS SOCKET, DO NOT PULL ON THE CABLE.
- DO NOT PLACE HOT ITEMS NEAR THE PLASTIC COMPONENTS OF THIS APPLIANCE.
- DO NOT PLACE FOOD PRODUCTS DIRECTLY AGAINST THE AIR OUTLET ON THE REAR WALL.
- STORE PRE-PACKED FROZEN FOOD IN ACCORDANCE WITH THE FROZEN FOOD MANUFACTURE'S INSTRUCTIONS.
- THE APPLIANCES MANUFACTURES STORAGE RECOMMENDATIONS SHOULD BE STRICTLY ADHERED TO. REFER TO RELEVANT INSTRUCTIONS FOR STORAGE.

- DO NOT PLACE CARBONATED OR FIZZY DRINKS IN THE FREEZER COMPARTMENT AS IT CREATES PRESSURE ON THE CONTAINER,WHICH MAY CAUSE IT TO EXPLODE,RESULTING IN DAMAGE TO THE APPLIANCE.
- FROZEN FOOD CAN CAUSE FROST BURNS IF CONSUMED STRAIGHT FROM THE FREEZER COMPARTMENT.
- DO NOT PLACE THE APPLIANCE IN DIRECT SUNLIGHT.
- KEEP BURNING CANDLES,LAMPS AND OTHER ITEMS WITH NAKED FLAMES AWAY FROM THE APPLIANCE SO THAT DO NOT SET THE APPLIANCE ON FIRE.
- THE APPLIANCE IS INTENDED FOR KEEPING FOOD STUFF AND/ OR BEVERAGES IN NORMAL HOUSEHOLD AS EXPLAINED IN THIS INSTRUCTION BOOKLET. YOU SHOULD TAKE CARE WHEN MOVE IT AS THE APPLIANCE IS HEAVY.
- DO NOT REMOVE OR TOUCH ITEMS FROM THE FREEZER COMPARTMENT IF YOUR HANDS ARE DAMP/WET, AS THIS COULD CAUSE SKIN ABRASIONS OR FROST/FREEZER BURNS.
- NEVER USE THE BASE,DRAWERS,DOORS ETC. TO STAND ON OR AS SUPPORTS.
- FROZEN FOOD MUST NOT BE REFROZEN ONCE IT HAS BEEN THAWED OUT.
- DO NOT CONSUME ICE POPSICLES OR ICE CUBES STRAIGHT FROM THE FREEZER AS THIS CAN CAUSE FREEZER BURN TO THE MOUTH AND LIPS.
- TO AVOID ITEMS FALLING AND CAUSING INJURY OR DAMAGE TO THE APPLIANCE,DO NOT OVERLOAD THE DOOR RACKS OR PUT TOO MUCH FOOD IN THE CRISPER DRAWERS.

INSTALLATION IMPORTANT!

- FOR ELECTRICAL CONNECTION CAREFULLY, FOLLOW THE INSTRUCTIONS GIVEN IN THIS MANUAL. UNPACK THE APPLIANCE AND CHECK IF THERE ARE DAMAGES ON IT.
- DO NOT CONNECT THE APPLIANCE IF IT IS DAMAGED. REPORT POSSIBLE DAMAGES IMMEDIATELY TO THE PLACE YOU BOUGHT IT. IN THIS CASE RETAIN PACKING.
- IT IS ADVISABLE TO WAIT AT LEAST FOUR HOURS BEFORE CONNECTING THE APPLIANCE TO ALLOW THE OIL TO FLOW BACK IN THE COMPRESSOR.
- ADEQUATE AIR CIRCULATION SHOULD BE AROUND THE APPLIANCE, LACKING THIS LEADS TO OVERHEATING. TO ACHIEVE SUFFICIENT VENTILATION, FOLLOW THE INSTRUCTIONS RELEVANT TO INSTALLATION.
- WHEREVER POSSIBLE THE BACK OF THE PRODUCT SHOULD NOT BE TOO CLOSE TO A WALL TO AVOID TOUCHING OR CATCHING WARM PARTS (COMPRESSOR, CONDENSER) TO PREVENT THE RISK OF A FIRE, FOLLOW THE INSTRUCTIONS RELEVANT TO INSTALLATION.
- THE APPLIANCE MUST NOT BE LOCATE CLOSE TO RADIATORS OR COOKERS.
- MAKE SURE THAT THE MAINS PLUG IS ACCESSIBLE AFTER THE INSTALLATION OF THE APPLIANCE.
- PLACE ALL PACKAGING MATERIALS OUT OF THE REACH OF CHILDREN, THERE IS A RISK OF SUFFOCATION.

PART 2: DESCRIPTION OF THE APPLIANCE

This type of refrigerator is widely used in places such as hotels ,offices, student dormitories and houses. It is mostly suitable for preserving foods such as fruits and beverage. It enjoys the advantages of small size, lightweight, low electric consumption and easy use.

Main configuration

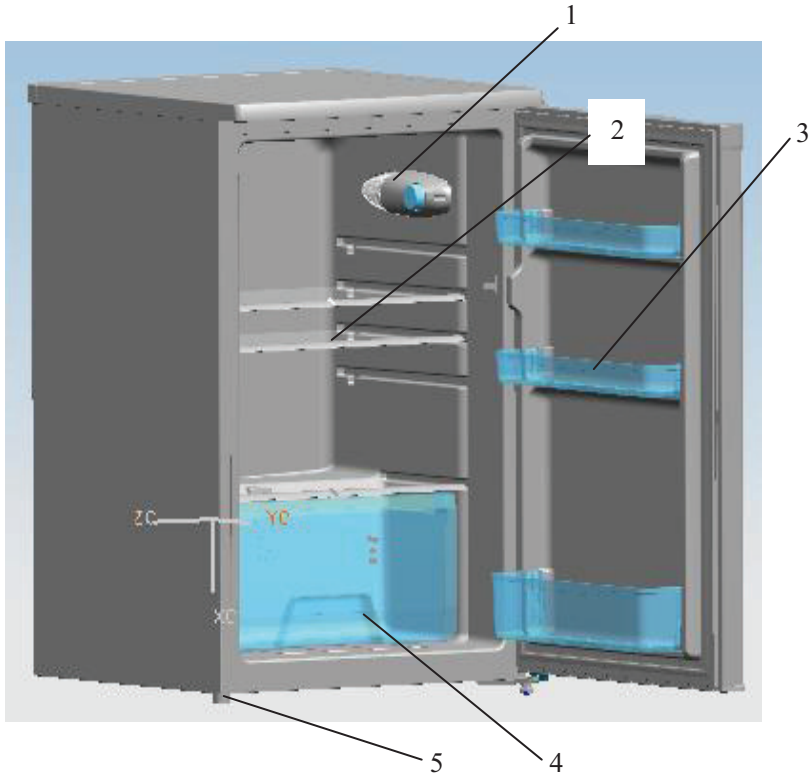

- 1 Thermostat
- 2 Glass shelf
- 3 Plastic pallet
- 4 Crisper
- 5 Leveler leg

PART 3: UNPACKING YOUR REFRIGERATOR

WARNING!

Use two or more people to move refrigerator.
Failure to do so can result in back or other injury.

- Remove tape and any labels from your refrigerator before using (except the rating label).
- To remove any remaining tape or glue, rub the area briskly with your thumb.
- Tape or glue residue can also be easily removed by rubbing a small amount of liquid dish soap over the adhesive with your fingers. Wipe with warm water and dry.
- Do not use sharp instruments, rubbing alcohol, flammable fluids, or abrasive cleaners to remove tape or glue. These products can damage the surface of your refrigerator.
- When moving the refrigerator, do not tilt the refrigerator beyond 45° from upright position.

PART 4: CLEANING BEFORE USE

After you remove all of the packaging materials, (especially the foam between outside condenser and cabinet should be removed) clean the inside of your refrigerator before using it.

PART 5: SPACE REQUIREMENTS

WARNING!

Keep flammable materials and vapors, such as gasoline, away from refrigerator.
Failure to do so can result in death, explosion, fire or burns.

- To ensure proper ventilation for your refrigerator, allow for 200 mm space on each side between walls, 200 mm space between back of your refrigerator and the wall, and 300 mm space between counter top and the roof or ceiling.
- If you are installing your refrigerator next to a fixed wall, leave sufficient space on the hinge side to allow for the door to swing open.
- Never install your refrigerator near heat source and direct sun shines.

PART 6: ELECTRICAL REQUIREMENT

WARNING!

DO NOT REMOVE GROUND PRONG.
DO NOT USE AN ADAPTOR.
DO NOT USE EXTENSION CORD.

Failure to follow these instructions can result in death, fire or electrical shock.
Before you move your refrigerator into its final location, it is important to make sure you have the proper electrical connection.

Recommended Earthing Method

AC220 - 240 Volt /50 Hz only 10 ampere fused and properly earthed electrical supply is required. It is recommended that a separate circuit serving only this appliance be provided. Use a receptacle which cannot be turned off with a switch or pull chain. Do not use an extension cord.

NOTE!

Before performing any type of installation, disconnect the refrigerator from the electrical source. When you are finished, connect the refrigerator to the electrical source and reset the control to the desired setting.

PART 7: LEVELING

If the refrigerator is not leveled during installation. The doors may not close or seal properly, causing cooling, frost, or moisture problems. It is very important of the refrigerator to be level in order to function properly. To level your refrigerator you may either turn the level leg clockwise to raise that side to the refrigerator or turn counter – clockwise to lower that side.

NOTE!

Having someone push against the top of the refrigerator take some weight off the leveling leg. This makes it easier to adjust the leveling leg.

PART 8: USE OF THE APPLIANCE

To obtain the best possible results from your refrigerator, it is important that you operate it properly.

Temperature Control

The temperature selector knob is located on the right hand side wall of the refrigerator interior

Setting "Off":	Unit Off
Setting "Min" or "1":	Less Cool Temperature
Setting "Med" or "3":	Normal Operation (adequate for most situations)
Setting "Max" or "6":	Coolest Temperature

- During high ambient temperatures e.g. on hot summer days. It may be necessary to set the thermostat to the Coolest setting (position "Max" or "6"). This may cause the compressor running continuously in order to maintain a low temperature in the cabinet.
- For the first time you install your refrigerator, set the thermostat knob at "Med" or "3". Give your refrigerator time to cool down completely before adding food. It is the best to wait 24 hours before adding food. The thermostat knob controls the temperature. When the thermostat control knob is set to OFF, the refrigerator will not be running.

Fresh Food Storage

Wrap or store food in the refrigerator in airtight and moisture – proof material. This prevents food odor and taste transfer throughout refrigerator.

- **Fruit**
Wash, let dry and store in refrigerator in plastic bags or crisper.
- **Leafy vegetables**
Remove wrapping and trim or tear off bruised and discolored areas, wash in cold water and drain. Place in plastic bag or plastic container and store in crisper.
- **Fish**
Use fresh fish the same day as purchased.
- **Meat**
Store most meat in original wrapping as long as it is airtight and moisture – proof. Re – wrap if necessary.
- **Leftovers**
Cover leftovers with plastic wrap or aluminum foil. Plastic containers with tight lid can also be used.

Defrosting

- **Refrigerator compartment**
Defrosting process is automatic by thermostat knob. Melted frost flows into drip tray and evaporates automatically.

Cleaning

1. Cleaning the Interior and the Exterior of the Unit

- Dusts behind the refrigerator and on the ground shall be timely cleaned to improve the cooling effect and energy saving.
- Check the door gasket regularly to make sure there are no debris. Clean the door gasket with a soft cloth dampened with soapy water or diluted detergent.
- The interior of the refrigerator should be cleaned regularly to avoid odor.
- Please turn off the power before cleaning interior, remove all foods, drinks, shelves, drawers, etc.
- Use a soft cloth or sponge to clean the inside of the refrigerator, with two tablespoons of baking soda and a quart of warm water. Then rinse with water and wipe clean. After cleaning, open the door and let it dry naturally before turning on the power.
- For areas that are difficult to clean in the refrigerator (such as narrow sandwiches, gaps or corners), it is recommended to wipe them regularly with a soft rag, soft brush, etc. and when necessary, combined with some auxiliary tools (such as thin sticks) to ensure no contaminants or bacteria accumulation in these areas.
- Do not use soap, detergent, scrub powder, spray cleaner, etc., as these may cause odors in the interior of the refrigerator or contaminated food.
- Clean the bottle frame, shelves and drawers with a soft cloth dampened with soapy water or diluted detergent. Dry with a soft cloth or dry naturally.
- Wipe the outer surface of the refrigerator with a soft cloth dampened with soapy water, detergent, etc., and then wipe dry.
- Do not use hard brushes, clean steel balls, wire brushes, abrasives (such as toothpastes), organic solvents (such as alcohol, acetone, banana oil, etc.), boiling water, acid or alkaline items, which may damage the fridge surface and interior. Boiling water and organic solvents such as benzene may deform or damage plastic parts.
- Do not rinse directly with water or other liquids during cleaning to avoid short circuits or affect electrical insulation after immersion.

2. Cleaning Tips

Condensation may appear on the outside of the unit. This may be due to a change in room temperature. Wipe off any moisture residue. If the problem continues, please contact a qualified technician for assistance.

PART 9: PROLONGED OFF PERIODS

If the refrigerator is not in use for a long period of time, proceed as follows:

Disconnect the refrigerator from the main supply by removing the plug from the wall socket.

Clean and dry the inside as instructed under the heading of cleaning the refrigerator.

Leave the door open to prevent any unpleasant smells from building up while the refrigerator is not in use.

PART 10: TROUBLESHOOTING

In case of malfunction, you can solve many common problems easily.

Problem	Check if / Solution
Your Refrigerator will not operate.	<ul style="list-style-type: none"> - The power supply cord is unplugged. - The thermostat knob is set to OFF position.
The light so not work.	<ul style="list-style-type: none"> - The power supply cord is unplugged. - A household fuse or circuit breaker has tripped. - A light bulb is loose in the socket. - A light bulb has burned out. - Contact a service center for repairs or replacements.
Food in the refrigerator compartment freezing.	<ul style="list-style-type: none"> - The thermostat knob is set too cold. - The position of food stored touches the refrigerant power of refrigerator back wall.
Food in the refrigerator compartment is not cold.	<ul style="list-style-type: none"> - The air vents are blocked in the compartment. This prevents the movement of cold air. - The door(s) are opened too often or not close properly. - A large amount of food has just been added to the refrigerator or refrigerator compartment. - The position of thermostat knob is adjusted too low.
Melted frost Leak over compartment inside or on floor.	<ul style="list-style-type: none"> - The drain – off mouth entrance is blocked. - Evaporator pan is in place.
The refrigerator seems to make unusual noise.	<ul style="list-style-type: none"> - The refrigerator is leveled on the floor. - The body of the refrigerator touches the wall. - The drip tray is not placed properly.
There is interior moisture build - up.	<ul style="list-style-type: none"> - The air vents are blocked in the refrigerator. - The door is opened often. - The room is humid. - The food is not packaged correctly. - The control is not set correctly of the surrounding conditions.
The doors will not close completely.	<ul style="list-style-type: none"> - The shelves are out of position - The gaskets are dirty. - The fridge is not level.

PART 11: REFRIGERATOR DOOR INSTALL GUIDELINES ABOUT SWAPPING LEFT&RIGHT

- 1 Disassemble the screws behind the fixed roof with cross-slot screwdriver and remove the cover from the refrigerator.

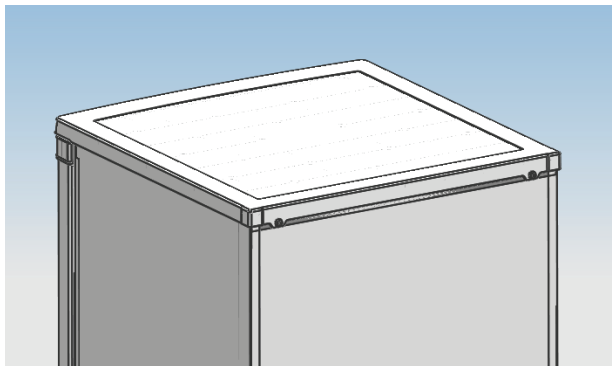

- 2 Remove the screws fixed the top-hinge with cross-slot screwdriver.

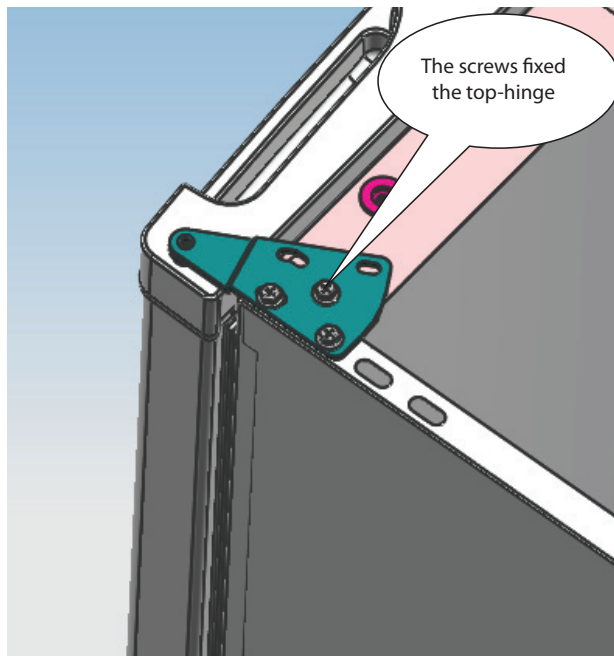

- 3 Replace the top-hinge and the door limit block and the door bearing bush to the other side
A replace the top-hinge.

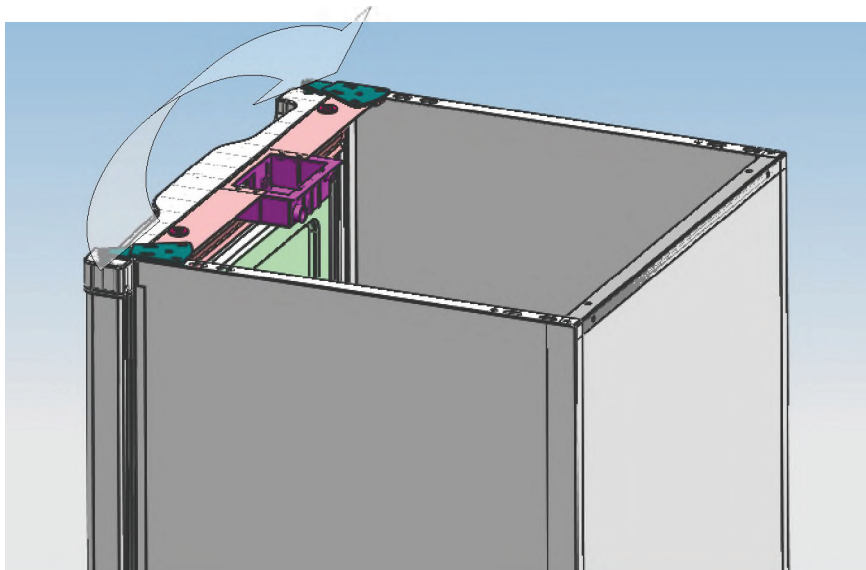

- B replace the door bearing bush and the limit block.

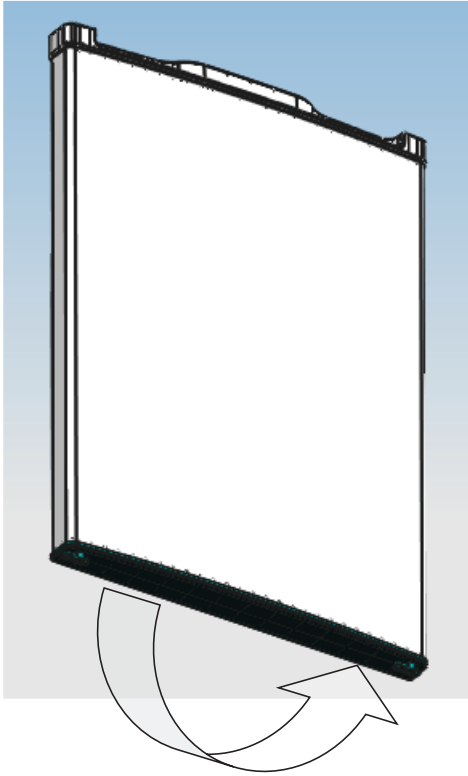

4 Disassemble the screws fixed the bottom-hinge with cross-slot screwdriver and replace the hinge to the other side then fix it with screws.

NOTE!

The refrigerator incline angle less 45°.

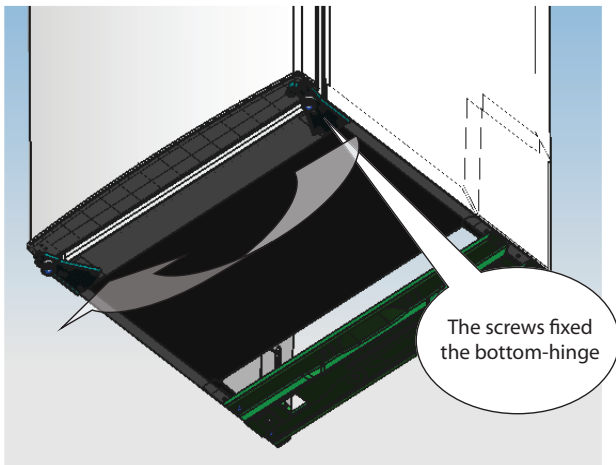

5 Replace the leveler to the other side and adjust it to make sure the cabinet level

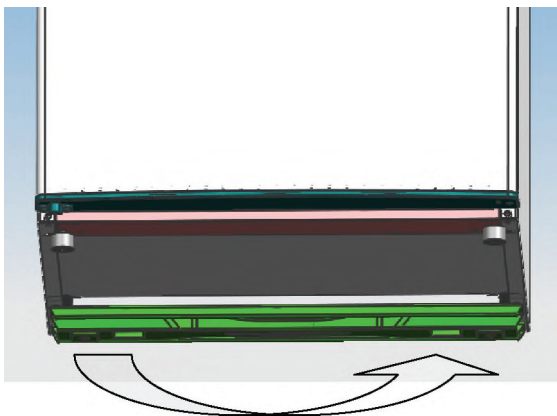

6 Set the door right position,fix the top-hinge and then the roof cover.

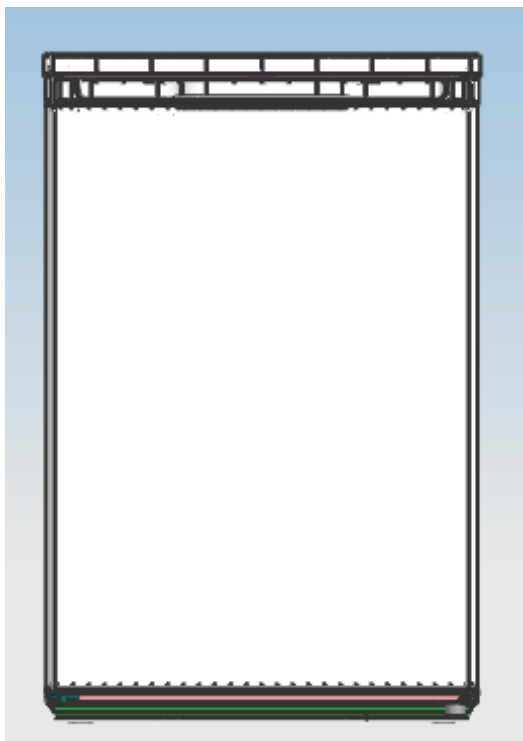

Ensure the Appliance is unplugged and empty.
Adjust the two leveling feet to their highest position.
We recommend you have someone to assist you.

NOTE!

To take the door off it is necessary to tilt the Appliance backward.
You should rest the Appliance on something solid e.g.a chair just below the top panel.

Do not lay the Appliance completely flat as this may damage the coolant system.

Energy Saving Tips

- The appliance should be located in the coolest area of the room, away from heat producing appliances or heating ducts, and out of the direct sunlight.
- Let hot foods cool to room temperature before placing in the appliance. Overloading the appliance forces the compressor to run longer. Foods that freeze too slowly may lose quality, or spoil.
- Be sure to wrap foods properly, and wipe containers dry before placing them in the appliance. This cuts down on frost build-up inside the appliance.
- Appliance storage bin should not be lined with aluminum foil, wax paper, or paper toweling. Liners interfere with cold air circulation, making the appliance less efficient.
- Organize and label food to reduce door openings and extended searches. Remove as many items as needed at one time, and close the door as soon as possible.

Daily use

To avoid contamination of food, please respect the following instructions

- Opening the door for long periods can cause a significant increase of the temperature in the compartments of the appliance.
- Clean regularly surfaces that can come in contact with food and accessible drainage systems.
- Clean water tanks if they have not been used for 48h; flush the water system connected to a water supply if water has not been drawn for 5 days.
- Store raw meat and fish in suitable containers in the refrigerator, so that it is not in contact with or drip onto other food.
- Two-star frozen-food compartments (if they are presented in the appliance) are suitable for storing pre-frozen food, storing or making ice-cream and making ice cubes.
- One-, two- and three -star compartments (if they are presented in the appliance) are not suitable for the freezing of fresh food.
- If the appliance is left empty for long periods, switch off, defrost, clean, dry and leave the door open to prevent mould developing within the appliance.

Position different food in different compartments according to below table

Refrigerator compartments	Type of food
Door of balconies of fridge compartments	<ul style="list-style-type: none">• Food with natural preservatives, such as jams, juices, drinks, condiments.• Do not store perishable foods.
Crisper drawer (salad drawer)	<ul style="list-style-type: none">• Fruits, herbs and vegetables should be placed separately in crisper bin.• Do not store bananas, onions, potatoes, garlic in the refrigerator.
Fridge shelf - bottom Chiller (box/drawer)	<ul style="list-style-type: none">• Raw meat, poultry, fish (for short-term storage)
Fridge shelf - middle	<ul style="list-style-type: none">• Dairy products, eggs.
Fridge shelf - top	<ul style="list-style-type: none">• Foods that do not need cooking, such as ready-to-eat foods, deli meats, leftovers.

Storage instructions

To avoid contamination of food, please respect the following instructions

- Opening the door for long periods can cause a significant increase of the temperature in the compartments of the appliance.
- Clean regularly surfaces that can come in contact with food and accessible drainage systems.
- Store raw meat and fish in suitable containers in the refrigerator, so that it is not in contact with or drip onto other food.
- Two-star frozen-food compartments are suitable for storing pre-frozen food, storing or making icecream and making ice cubes.
- One-, two- and three-star compartments are not suitable for the freezing of fresh food.

Order	Compartments TYPE	Target storage temp.[°C]	Appropriate food
1	Fridge	+2~+8	Eggs, cooked food, packaged food, fruits and vegetables, dairy products, cakes, drinks and other foods which are not suitable for freezing.
2	(***)*-Freezer	≤-18	Seafood (fish,shrimp,shellfish),freshwater aquatic products and meat products (recommended for 3 months , he longer the storage time,the worse the taste and nutrition),suitable for frozen fresh food.
3	***-Freezer	≤-18	Seafood (fish, shrimp, shellfish),freshwater aquatic products and meat products (recommended for 3 months, the longer the storage time,the worse the taste and nutrition), are not suitable for frozen fresh food
4	**-Freezer	≤-12	Seafood (fish, shrimp, shellfish), freshwater aquatic products and meat products (recommended for 2 months,the longer the storage time,the worse the taste and nutrition), are not suitable for frozen fresh food.
5	*-Freezer	≤-6	Seafood (fish, shrimp, shellfish), freshwater aquatic products and meat products (recommended for 1 month,the longer the storage time,the worse the taste and nutrition), are not suitable for frozen fresh food.
6	0-star	-6~0	Fresh pork, beef, fish, chicken, some packaged processed foods, etc. (Recommended to eat within the same day, preferably no later than 3 days). Partially encapsulated processed foods (non-freezable foods.)

7	Chill	-2~+3	Fresh/frozen pork, beef, chicken, freshwater aquatic products, etc. (7 days below 0 °C and above 0 °C is recommended for consumption within that day, preferably no more than 2 days). Seafood (less than 0 for 15 days, it is not recommended to store above 0 °C).
8	Fresh Food	0~+4	Fresh pork,beef,fish,chicken,cooked food,etc. (Recommended to eat within the same day,preferably no more than 3 days.)
9	Wine	+5~+20	Red wine,white wine,sparkling wine etc.

Note: Please store different foods according to the compartments or target storage temperature of your purchased products.

- If the refrigerating appliance is left empty for long periods,switch off,defrost, clean,dry, and leave the door open to prevent mould developing within the appliance.

PART 12: Product Information Sheet

Product Information Sheet

PHILCO 

COMMISSION DELEGATED REGULATION (EU) 2019/2016

Supplier's name or trademark: PHILCO

Supplier's address: PHILCO, FAST ČR, a.s. U Sanitasu 1621 Říčany 251 01, Czech Republic

Model identifier: PTL 1302 W

Type of refrigerating appliance: Monoclima refrigerator

Low-noise appliance:	No	Design type:	freestanding
----------------------	----	--------------	--------------

Wine storage appliance:	No	Other refrigerating appliance:	Yes
-------------------------	----	--------------------------------	-----

General product parameters:

Parameter	Value	Parameter	Value
Overall dimensions (millimetre)	Height	Total volume (dm ³ or l)	131
	Width		
	Depth		
Energy efficiency Index (EEL)	100	Energy efficiency class*	E
Airborne acoustical noise emissions (dB(A) re 1 pW)	39	Airborne acoustical noise emission class	C
Annual energy consumption (kWh/a)	90	Climate class:	ST/N/SN
Minimum ambient temperature (°C), for which the refrigerating appliance is suitable	10	Maximum ambient temperature (°C), for which the refrigerating appliance is suitable	38
Winter setting	No		

Compartment Parameters:

Compartment type	Compartment parameters and values				
	Compartment volume (dm ³ or l)	Recommended temperature setting for optimised food storage (°C) These settings shall not contradict the storage conditions set out in Annex IV, Table 3	Freezing capacity (kg/24h)	Defrosting type (auto-defrost=A, manual defrost=M)	
Pantry	No	-	-	-	-
Wine storage	No	-	-	-	-
Cellar	No	-	-	-	-
Fresh food	Yes	131	4	-	M
Chill	No	-	-	-	-

0-star or ice-making	No	-	-	-	-
1-star	No	-	-	-	-
2-star	No	-	-	-	-
3-star	No	-	-	-	-
4-star	No	-	-	-	-
2-star section	No	-	-	-	-
Variable temperature compartment	-	-	-	-	-
Light source parameters:					
Type of light source	LED				
Energy efficiency class	-				
Minimum duration of the guarantee offered by the manufacturer: 24 months					
Additional information:					
Weblink to the manufacturer's website, where the information in point4(a) Annex of Commission Regulation (EU) 2019/2019 is found: www.philco.cz					

* A (highest efficiency) to G (lowest efficiency)

TECHNICAL INFORMATION

Technical information can be found on the type plate on the inside of the appliance and on the energy label. The QR code, on the supplied energy label, contains a link to register the appliance in the EU Eprel database. Keep the energy label, the instructions for use, together with other documents supplied with the device.

TESTING INFORMATION

The delivered device is in accordance with EcoDesign and EN 62552-1:2020, EN 62552-2:2020, EN 62552-3:2020; EN 60704-1:2010 +A11:2012; EN 60704-2-14:2013+A11:2015+A1:2019. Air access requirements for proper operation of the device, the minimum distance from the wall and the dimensions of the device are part of this manual. If you have any further questions, please contact the manufacturer.

CUSTOMER CARE AND SERVICE

Always use original spare parts.

Model name and serial number can be found on the rating plate. Position of rating plate can be changed without notice.

The original spare parts for some specific components are available for a minimum of 7 or 10 years, based on the type of component, from the placing on the market of the last unit of the model.

When contacting our authorized service, have the model designation, serial number and defect description available.

To download documents, visit www.philco.cz.

To report a defect and obtain additional service information, visit <https://philco.cz/podpora-a-servis>.

Subject to change without notice.

INSTRUCTIONS AND INFORMATION REGARDING THE DISPOSAL OF USED PACKAGING MATERIALS

Dispose of packaging material at a public waste disposal site.

DISPOSAL OF USED ELECTRICAL AND ELECTRONIC APPLIANCES



The meaning of the symbol on the product, its accessory or packaging indicates that this product shall not be treated as household waste. Please, dispose of this product at your applicable collection point for the recycling of electrical & electronic equipment waste. Alternatively in some states of the European Union or other European states you may return your products to your local retailer when buying an equivalent new product. The correct disposal of this product will help save valuable natural resources and help in preventing the potential negative impact on the environment and human health, which could be caused as a result of improper liquidation of waste. Please ask your local authorities or the nearest waste collection centre for further details. The improper disposal of this type of waste may fall subject to national regulations for fines.

For business entities in the European Union

If you wish to dispose of an electrical or electronic device, request the necessary information from your seller or supplier.

Disposal in other countries outside the European Union

If you wish to dispose of this product, request the necessary information about the correct disposal method from local government departments or from your seller.



This product meets all the basic EU regulation requirements that relate to it.

Changes to the text, design and technical specifications may occur without prior notice and we reserve the right to make these changes.



WARNING! DURING USING, SERVICE AND DISPOSAL THE APPLIANCE, PLEASE PAY ATTENTION TO SYMBOL SIMILAR AS LEFT SIDE, WHICH IS LOCATED ON REAR OF APPLIANCE (REAR PANEL OR COMPRESSOR) AND WITH YELLOW OR ORANGE COLOR.



IT'S RISK OF RE WARNING SYMBOL. THERE ARE FLAMMABLE MATERIALS IN REFRIGERANT PIPES AND COMPRESSOR. PLEASE BE FAR AWAY RE SOURCE DURING USING, SERVICE AND DISPOSAL.

Výrobce/Manufacturer:
Fast ČR, a.s.
U Sanitasy 1621
Říčany 251 01, CZECH REPUBLIC

Distributor:
FAST PLUS, a.s.,
Vlčie hrdlo 324/90
821 07 Bratislava, SLOVAKIA

Distributor:
FAST POLAND Sp. z o. o.
Kwiatniowa 36
05-090 Wypędy, POLAND

Distributor:
FAST HUNGARY Kft.
H-2310 Szigetszentmiklós
Kántor utca 10, HUNGARY

PHILCO[®] 

is a pending or registered trademark of Electrolux Home Products, Inc. and used under a license from Electrolux Home Products, Inc.