

INDUCTION HOB

OWNER'S MANUAL

PHILCO



Famous for Quality the World Over

PHD 60 IP

**Dear customer,
Thank you for buying a PHILCO brand product. So that your appliance serves you well, please read all the instructions in this user's manual.**

CONTENTS

| | |
|-------------------------------------------------------|-----------|
| 1. SAFETY | 2 |
| 2. PRODUCT INTRODUCTION | 5 |
| 2.2 Control Panel | 5 |
| 2.3 Working Theory..... | 6 |
| 2.4 Before using your New Induction Hob..... | 6 |
| 2.5 Technical Specification..... | 6 |
| 3. OPERATION OF PRODUCT..... | 7 |
| 3.1 Touch Controls | 7 |
| 3.2 Choosing the right Cookware..... | 7 |
| 3.3 How to use..... | 9 |
| 4. COOKING GUIDELINES | 13 |
| 4.1 Cooking Tips..... | 13 |
| 4.2 Detection of Small Articles | 14 |
| 5. HEAT SETTINGS | 14 |
| 6. CARE AND CLEANING | 15 |
| 7. HINTS AND TIPS | 16 |
| 8. FAILURE DISPLAY AND INSPECTION..... | 17 |
| Troubleshooting | 17 |
| 9. INSTALLATION..... | 19 |
| 9.1 Selection of installation equipment..... | 19 |
| 9.2 Before installing the hob, make sure that | 21 |
| 9.3 After installing the hob, make sure that | 22 |
| 9.4 Before locating the fixing brackets..... | 22 |
| 9.5 Adjusting the bracket position..... | 22 |
| 9.6 Cautions..... | 23 |
| 9.7 Connecting the hob to the mains power supply..... | 23 |

1. SAFETY

THIS APPLIANCE CAN BE USED BY CHILDREN AGED FROM 8 YEARS AND ABOVE AND BY PERSONS WITH REDUCED PHYSICAL, SENSORY OR MENTAL CAPABILITIES OR LACK OF EXPERIENCE AND KNOWLEDGE IF THEY HAVE BEEN GIVEN SUPERVISION OR INSTRUCTIONS CONCERNING USE OF THE APPLIANCE IN A SAFE WAY AND IF THEY UNDERSTAND THE HAZARDS INVOLVED.

CHILDREN MUST NOT PLAY WITH THE APPLIANCE.

CLEANING AND USER MAINTENANCE CANNOT BE PERFORMED BY CHILDREN WITHOUT SUPERVISION.

IF THE SUPPLY CABLE GETS DAMAGED, HAVE IT REPLACED BY A SPECIALIZED SERVICE CENTRE IN ORDER TO AVOID DANGEROUS SITUATION.

IT IS PROHIBITED TO USE THE APPLIANCE WHEN THE SUPPLY CABLE IS DAMAGED



CAUTION, HOT SURFACE

CAUTION: IF THE SURFACE IS CRACKED, TURN THE APPLIANCE OFF TO PREVENT RISK OF ELECTRIC SHOCK.

CAUTION: THE APPLIANCE AND ITS ACCESSIBLE PARTS GET HOT DURING USE.

PLEASE MAKE SURE TO REFRAIN FROM TOUCHING THE HEATING ELEMENTS.

KEEP CHILDREN BELOW 8 YEARS OF AGE AWAY FROM THE APPLIANCE IF THEY ARE NOT UNDER CONSTANT SUPERVISION.

WHEN CLEANING THE OVEN DOOR GLASS / COOKING HOB GLASS HINGED COVERS, DO NOT USE HARSH ABRASIVE CLEANING AGENTS OR SHARP METAL SCRAPERS AS THE SURFACE MIGHT BECOME SCRATCHED WHICH COULD RESULT IN THE GLASS BREAKING.

STEAM CLEANERS MUST NOT BE USED TO CLEAN COOKING HOBS.

METAL OBJECTS SUCH AS KNIVES, FORKS, SPOONS AND POT LIDS MUST NOT BE PLACED ON THE COOKING HOB AS THEY MIGHT GET HOT.

THIS APPLIANCE IS NOT INTENDED TO BE USED WITH EXTERNAL TIME SWITCH OR SEPARATE REMOTE CONTROL SYSTEM.

CAUTION: COOKING ON THE COOKING HOB USING FAT OR OIL WITHOUT SUPERVISION CAN BE DANGEROUS AND CAN CAUSE FIRE.

NEVER TRY TO EXTINGUISH FIRE USING WATER; YOU SHOULD RATHER TURN THE APPLIANCE OFF AND THEN COVER THE FLAMES E.G. USING A LID OR A FIRE-STOPPING COVER.

NOTICE: COOKING PROCESS MUST BE UNDER SUPERVISION. SHORT-TIME COOKING PROCESS MUST BE UNDER SUPERVISION CONSTANTLY.

CAUTION: FIRE HAZARD: DO NOT PLACE ANY OBJECTS ON THE COOKING SURFACE.

CAUTION: USE ONLY COOKING HOB PROTECTIVE COVERS MADE BY THE MANUFACTURER OF THE COOKING APPLIANCE OR STATED BY THE MANUFACTURER OF THE APPLIANCE AS SUITABLE IN THE RESPECTIVE USER'S MANUAL OR COOKING HOB PROTECTIVE COVERS BUILT-IN IN THE APPLIANCE. USING INCORRECT PROTECTIVE COVERS CAN CAUSE ACCIDENTS.

2. PRODUCT INTRODUCTION

2.1 Top View

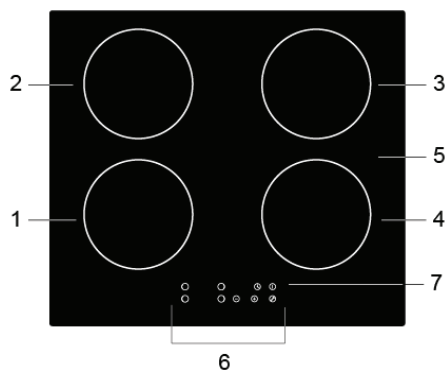

1. Max. 1500 W zone
2. Max. 2000 W zone
3. Max. 2000 W zone
4. Max. 1500 W zone
5. Glass plate
6. Control panel
7. ON/OFF control

2.2 Control Panel

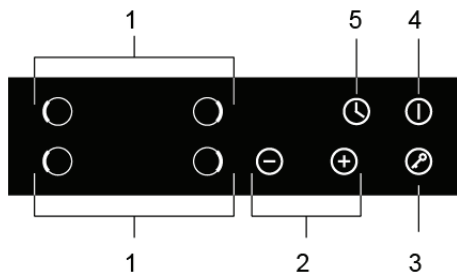

1. Heating zone selection controls
2. Power / Timer regulating key
3. Keylock control
4. ON/OFF control
5. Timer control

2.3 Working Theory

Induction cooking is a safe, advanced, efficient, and economical cooking technology. It works by electromagnetic vibrations generating heat directly in the pan, rather than indirectly through heating the glass surface. The glass becomes hot only because the pan eventually warms it up.

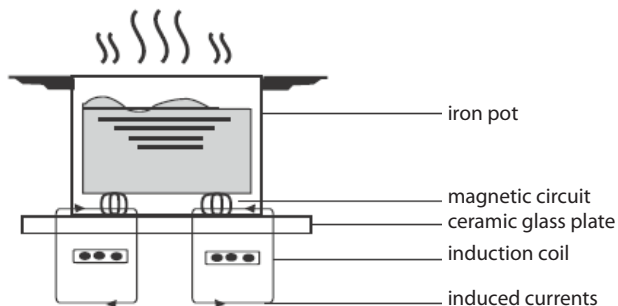

2.4 Before using your New Induction Hob

- Read this guide, taking special note of the 'Safety Warnings' section.
- Remove any protective film that may still be on your Induction hob.

2.5 Technical Specification

| | |
|---------------------------------|------------------------|
| Cooking Hob | PHD 60 IP |
| Cooking Zones | 4 Zones |
| Supply Voltage | 220-240V~ 50Hz or 60Hz |
| Installed Electric Power | 3000W |
| Product Size LxWxH(mm) | 590X520X60 |
| Building-in Dimensions AxB (mm) | 560X490 |

Weight and Dimensions are approximate. Because we continually strive to improve our products we may change specifications and designs without prior notice.

3. OPERATION OF PRODUCT

3.1 Touch Controls

- The controls respond to touch, so you don't need to apply any pressure.
- Use the ball of your finger, not its tip.
- You will hear a beep each time a touch is registered.
- Make sure the controls are always clean, dry, and that there is no object (e.g. a utensil or a cloth) covering them. Even a thin film of water may make the controls difficult to operate.

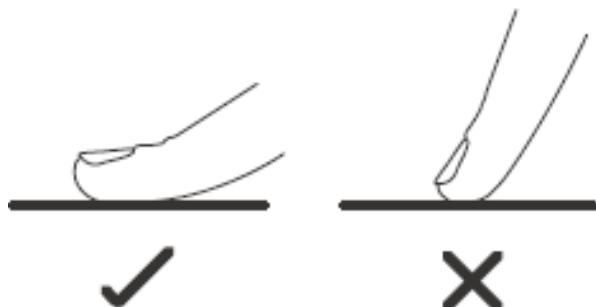

3.2 Choosing the right Cookware



- Only use cookware with a base suitable for induction cooking. Look for the induction symbol on the packaging or on the bottom of the
- You can check whether your cookware is suitable by carrying out a magnet test.

Move a magnet towards the base of the pan. If it is attracted, the pan is suitable for induction.

- If you do not have a magnet:
 1. Put some water in the pan you want to check.
 2. If  does not flash in the display and the water is heating, the pan is suitable.
- Cookware made from the following materials is not suitable: pure stainless steel, aluminium or copper without a magnetic base, glass, wood, porcelain, ceramic, and earthenware.

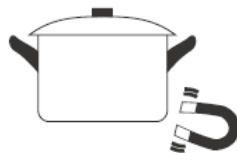

Do not use cookware with jagged edges or a curved base.



Make sure that the base of your pan is smooth, sits flat against the glass, and is the same size as the cooking zone. Use pans whose diameter is as large as the graphic of the zone selected. Using a pot a slightly wider energy will be used at its maximum efficiency. If you use smaller pot efficiency could be less than expected. Pot less than 140 mm could be undetected by the hob. Always centre your pan on the cooking zone.

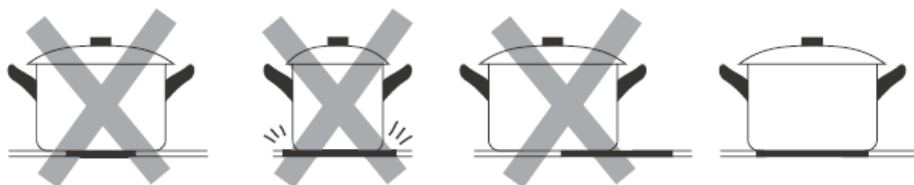

Always lift pans off the Induction hob – do not slide, or they may scratch the glass.

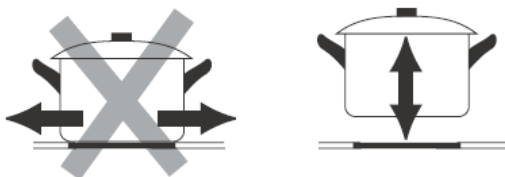

3.3 How to use

3.3.1 Start cooking

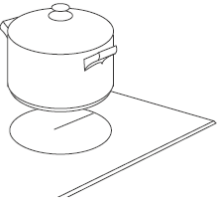
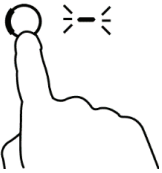
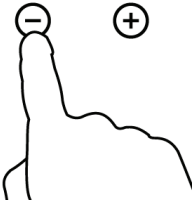
| | |
|---------------------------------------------------------------------------------------------------------------------------------------------------------------------------------------------------------------------------------------------------------------------------------------------------------------------------------------|------------------------------------------------------------------------------------|
| <p>Touch the ON/OFF control for three seconds. After power on, the buzzer beeps once, all displays show “-” or “- -”, indicating that the induction hob has entered the state of standby mode.</p> |  |
| <p>Place a suitable pan on the cooking zone that you wish to use.</p> <ul style="list-style-type: none">• Make sure the bottom of the pan and the surface of the cooking zone are clean and dry. |  |
| <p>Touching the heating zone selection control, and a indicator next to the key will flash</p> |  |
| <p>Select a heat setting by touching the “-” or “+” control.</p> <ul style="list-style-type: none">• If you don't choose a heat setting within 1 minute, the Induction hob will automatically switch off. You will need to start again at step 1.• You can modify the heat setting at any time during cooking. |  |

Warning:

The whole hob can take in charge a maximum power of 3000W. Consequently, the hob automatically reduces the maximum output power by allowing a maximum sum of the all power levels of 12.

If the display flashes $\geq \underline{U} \leq$ alternately with the heat setting





This means that:

- you have not placed a pan on the correct cooking zone or,
- the pan you're using is not suitable for induction cooking or,
- the pan is too small or not properly centered on the cooking zone.

No heating takes place unless there is a suitable pan on the cooking zone.

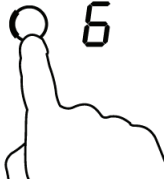
The display "U" will automatically disappear after 1 minute if no suitable pan is placed on it.

3.3.2 Finish cooking

| | |
|---------------------------------------------------------------------------------------------------------------------------------------------------------------------------------------------------------------------------------------------------------------------------------------------------------------------------|------------------------------------------------------------------------------------|
| Touching the heating zone selection control that you wish to switch off |  |
| Turn the cooking zone off by scrolling down to "0" or touching "-" and "+" control together. Make sure the display shows "0". |  |
| Turn the whole cooktop off by touching the ON/OFF control. |  |
| Beware of hot surfaces <ul style="list-style-type: none">• H will show which cooking zone is hot to touch. It will disappear when the surface has cooled down to a safe temperature. It can also be used as an energy saving function if you want to heat further pans, use the hotplate that is still hot. |  |

3.3.3 Locking the Controls

- You can lock the controls to prevent unintended use (for example children accidentally turning the cooking zones on).
- When the controls are locked, all the controls except the ON/OFF control are disabled.

| To lock the controls | |
|----------------------------------------------|------------------------------------|
| Touch the lock control | The timer indicator will show "Lo" |
| To unlock the controls | |
| Touch and hold the lock control for a while. | |

 When the hob is in the lock mode, all the controls are disabled except the ON/OFF , you can always turn the induction hob off with the ON/OFF  control in an emergency, but you shall unlock the hob first in the next operation.



3.3.4 Timer control

You can use the timer in two different ways:



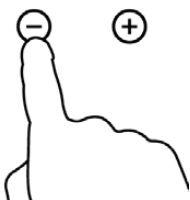

- You can use it as a minute minder. In this case, the timer will not turn any cooking zone off when the set time is up.
- You can set it to turn one or more cooking zones off after the set time is up.
The timer of maximum is 99 min.

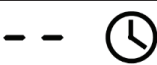
a) Using the Timer as a Minute Minder

If you are not selecting any cooking zone

| | |
|-----------------------------------------------------------------------------------------------------------------------------------------------------------------------------------------------------------------------------------------------------------------|---------------------------------------------------------------------------------------------------------------------------|
| <p>Make sure the cooktop is turned on. Note: you can use the minute minder even if you're not selecting any cooking zone.</p> |  |
| <p>Touch "+" the controls of the timer. The minder indicator will start flashing and "10" will show in the timer display.</p> | |
| <p>Set the time by touching the "-" or "+" control of the timer Hint: Touch the "-" or "+" control of the timer to decrease or increase by 1 minute once. Touch and hold the "-" or "+" control of the timer to decrease or increase by 10 minutes.</p> |  |
| <p>Touching the "-" and "+" together, the timer is cancelled, and the "00" will show in the minute display.</p> |  |
| <p>When the time is set, it will begin to count down immediately. The display will show the remaining time and the timer indicator will flash for 5 seconds.</p> |  |
| <p>Buzzer will beep for 30 seconds and the timer indicator shows "--" when the setting time finished.</p> |  |

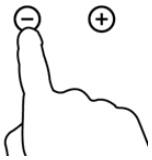
b) Setting the timer to turn one cooking zone off

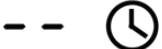
| Set one zone | |
|------------------------------------------------------------------------------------------------------------------------------------------------------------------------------------------------------------------------------------------------------------|-------------------------------------------------------------------------------------|
| Touching the heating zone selection control that you want to set the timer for. (e.g. zone 3#) |  |
| Touch timer control, the minder indicator will start flashing and "10" will show in the timer display. |  |
| Set the time by touching the "-" or "+" control of the timer Hint: Touch the "-" or "+" control of the timer once will decrease or increase by 1 minute. Touch and hold the "-" or "+" control of the timer will decrease or increase by 10 minutes. |  |
| Touching the "-" and "+" together, the timer is cancelled, and the "00" will show in the minute display. |  |
| When the time is set, it will begin to count down immediately. The display will show the remaining time and the timer indicator flash for 5 seconds. NOTE: The red dot next to power level indicator will illuminate indicating that zone is selected. |  |
| When cooking timer expires, the corresponding cooking zone will be switched off automatically. |  |

 Other cooking zone will keep operating if they are turned on previously.

3.3.5 Default working times

Auto shut down is a safety protection function for your induction hob. It shut down automatically if ever you forget to turn off your cooking. The default working times for various power levels are shown in the below table:

| | | | | | | | | | |
|------------------------------|---|---|---|---|---|---|---|---|---|
| Power level | 1 | 2 | 3 | 4 | 5 | 6 | 7 | 8 | 9 |
| Default working timer (hour) | 8 | 8 | 8 | 4 | 4 | 4 | 2 | 2 | 2 |

When the pot is removed, the induction hob can stop heating immediately and the hob automatically switch off after 2 minutes.



People with a heart pace maker should consult with their doctor before using this unit.

4. COOKING GUIDELINES



Take care when frying as the oil and fat heat up very quickly, particularly if you're using PowerBoost. At extremely high temperatures oil and fat will ignite spontaneously and this presents a serious fire risk.

4.1 Cooking Tips

- When food comes to the boil, reduce the temperature setting.
- Using a lid will reduce cooking times and save energy by retaining the heat.
- Minimize the amount of liquid or fat to reduce cooking times.
- Start cooking on a high setting and reduce the setting when the food has heated through.

4.1.1 Simmering, cooking rice

- Simmering occurs below boiling point, at around 85 °C, when bubbles are just rising occasionally to the surface of the cooking liquid. It is the key to delicious soups and tender stews because the flavours develop without overcooking the food. You should also cook egg-based and flour thickened sauces below boiling point.
- Some tasks, including cooking rice by the absorption method, may require a setting higher than the lowest setting to ensure the food is cooked properly in the time recommended.

4.1.2 Searing steak

To cook juicy flavorsome steaks:

1. Stand the meat at room temperature for about 20 minutes before cooking.
2. Heat up a heavy-based frying pan.
3. Brush both sides of the steak with oil. Drizzle a small amount of oil into the hot pan and then lower the meat onto the hot pan.
4. Turn the steak only once during cooking. The exact cooking time will depend on the thickness of the steak and how cooked you want it. Times may vary from about 2 – 8 minutes per side. Press the steak to gauge how cooked it is – the firmer it feels the more 'well done' it will be.
5. Leave the steak to rest on a warm plate for a few minutes to allow it to relax and become tender before serving.

4.1.3 For stir-frying

1. Choose an induction compatible flat-based wok or a large frying pan.
2. Have all the ingredients and equipment ready. Stir-frying should be quick. If cooking large quantities, cook the food in several smaller batches.
3. Preheat the pan briefly and add two tablespoons of oil.
4. Cook any meat first, put it aside and keep warm.
5. Stir-fry the vegetables. When they are hot but still crisp, turn the cooking zone to a lower setting, return the meat to the pan and add your sauce.
6. Stir the ingredients gently to make sure they are heated through.
7. Serve immediately.

4.2 Detection of Small Articles

When an unsuitable size or non-magnetic pan (e.g. aluminium), or some other small item (e.g. knife, fork, key) has been left on the hob, the hob automatically go on to standby in 1 minute. The fan will keep cooking down the induction hob for a further 1 minute.

5. HEAT SETTINGS

The settings below are guidelines only. The exact setting will depend on several factors, including your cookware and the amount you are cooking. Experiment with the induction hob to find the settings that best suit you.

| Heat setting | Suitability |
|--------------|-----------------------------------------------------------------------------------------------------------------------------------------------------------------------------------------------------------------|
| 1 - 2 | <ul style="list-style-type: none">• delicate warming for small amounts of food• melting chocolate, butter, and foods that burn quickly• gentle simmering• slow warming |
| 3 - 4 | <ul style="list-style-type: none">• reheating• rapid simmering• cooking rice |
| 5 - 6 | <ul style="list-style-type: none">• pancakes |
| 7 - 8 | <ul style="list-style-type: none">• sautéing• cooking pasta |
| 9 | <ul style="list-style-type: none">• stir-frying• searing• bringing soup to the boil• boiling water |

6. CARE AND CLEANING

| What? | How? | Important! |
|------------------------------------------------------------------------------------------------------------|------------------------------------------------------------------------------------------------------------------------------------------------------------------------------------------------------------------------------------------------------------------------------------------------------------------------------------------------------------------------------------------------------------------------------------------------------------------------------------------------------------------------------------------------------|-----------------------------------------------------------------------------------------------------------------------------------------------------------------------------------------------------------------------------------------------------------------------------------------------------------------------------------------------------------------------------------------------------------------------------------------------------------------------------------|
| Everyday soiling on glass (fingerprints, marks, stains left by food or non-sugary spillovers on the glass) | <ol style="list-style-type: none"> 1. Switch the power to the cooktop off. 2. Apply a cooktop cleaner while the glass is still warm (but not hot!) 3. Rinse and wipe dry with a clean cloth or paper towel. 4. Switch the power to the cooktop back on. | <ul style="list-style-type: none"> • When the power to the cooktop is switched off, there will be no 'hot surface' indication but the cooking zone may still be hot! Take extreme care. • Heavy-duty scourers, some nylon scourers and harsh/abrasive cleaning agents may scratch the glass. Always read the label to check if your cleaner or scourer is suitable. • Never leave cleaning residue on the cooktop: the glass may become stained. |
| Boilovers, melts, and hot sugary spills on the glass | <p>Remove these immediately with a fish slice, palette knife or razor blade scraper suitable for Induction glass cooktops, but beware of hot cooking zone surfaces:</p> <ol style="list-style-type: none"> 1. Switch the power to the cooktop off at the wall. 2. Hold the blade or utensil at a 30° angle and scrape the soiling or spill to a cool area of the cooktop. 3. Clean the soiling or spill up with a dish cloth or paper towel. 4. Follow steps 2 to 4 for 'Everyday soiling on glass' above. | <ul style="list-style-type: none"> • Remove stains left by melts and sugary food or spillovers as soon as possible. If left to cool on the glass, they may be difficult to remove or even permanently damage the glass surface. • Cut hazard: when the safety cover is retracted, the blade in a scraper is razor-sharp. Use with extreme care and always store safely and out of reach of children. |
| Spillovers on the touch controls | <ol style="list-style-type: none"> 1. Switch the power to the cooktop off. 2. Soak up the spill 3. Wipe the touch control area with a clean damp sponge or cloth. 4. Wipe the area completely dry with a paper towel. 5. Switch the power to the cooktop back on. | <ul style="list-style-type: none"> • The cooktop may beep and turn itself off, and the touch controls may not function while there is liquid on them. Make sure you wipe the touch control area dry before turning the cooktop back on. |

7. HINTS AND TIPS

| Problem | Possible causes | What to do |
|-------------------------------------------------------------------------------|----------------------------------------------------------------------------------------------------------------------------------------------------------------------------------------------------------------------|------------------------------------------------------------------------------------------------------------------------------------------------------------------------------------------------------------------------------------------|
| The induction hob cannot be turned on. | No power. | Make sure the induction hob is connected to the power supply and that it is switched on. Check whether there is a power outage in your home or area. If you've checked everything and the problem persists, call a qualified technician. |
| The touch controls are unresponsive. | The controls are locked. | Unlock the controls. See section 'Using your induction cooktop' for instructions. |
| The touch controls are difficult to operate. | There may be a slight film of water over the controls or you may be using the tip of your finger when touching the controls. | Make sure the touch control area is dry and use the ball of your finger when touching the controls. |
| The glass is being scratched. | Rough-edged cookware. Unsuitable, abrasive scourer or cleaning products being used. | Use cookware with flat and smooth bases. See "Choosing the right cookware" See "Care and cleaning". |
| Some pans make crackling or clicking noises. | This may be caused by the construction of your cookware (layers of different metals vibrating differently). | This is normal for cookware and does not indicate a fault. |
| The induction hob makes a low humming noise when used on a high heat setting. | This is caused by the technology of induction cooking. | This is normal, but the noise should quieten down or disappear completely when you decrease the heat setting. |
| Fan noise coming from the induction hob. | A cooling fan built into your induction hob has come on to prevent the electronics from overheating. It may continue to run even after you've turned the induction hob off. | This is normal and needs no action. Do not switch the power to the induction hob off at the wall while the fan is running. |
| Pans do not become hot and appears in the display. | The induction hob cannot detect the pan because it is not suitable for induction cooking. The induction hob cannot detect the pan because it is too small for the cooking zone or not properly centred on it. | Use cookware suitable for induction cooking. See section "Choosing the right cookware". Centre the pan and make sure that its base matches the size of the cooking zone. |

| Problem | Possible causes | What to do |
|---------------------------------------------------------------------------------------------------------------------------------------------------------------------------------------------------|------------------|--------------------------------------------------------------------------------------------------------------------------------------------|
| The induction hob or a cooking zone has turned itself off unexpectedly, a tone sounds and an error code is displayed (typically alternating with one or two digits in the cooking timer display). | Technical fault. | Please note down the error letters and numbers, switch the power to the induction hob off at the wall, and contact a qualified technician. |

8. FAILURE DISPLAY AND INSPECTION

The induction hob is equipped with a self diagnostic function. With this test the technician is able to check the function of several components without disassembling or dismantling the hob from the working surface.

Troubleshooting

1) Failure code occur during customer using & Solution;

| Failure code | Problem | Solution |
|----------------------|------------------------------------------------|----------------------------------------------------------------------------------------------------------------------------------------------------------------|
| Auto-Recovery | | |
| E1 | Supply voltage is above the rated voltage. | Please inspect whether power supply is normal. Power on after the power supply is normal. |
| E2 | Supply voltage is below the rated voltage. | |
| E3 | High temperature of ceramic plate sensor. (1#) | Wait for the temperature of ceramic plate return to normal. Touch "ON/OFF" button to restart unit. |
| E4 | High temperature of ceramic plate sensor. (2#) | |
| E5 | High temperature of IGBT. (1#) | Wait for the temperature of IGBT return to normal. Touch "ON/OFF" button to restart unit. Check whether the fan runs smoothly; if not , replace the fan. |
| E6 | High temperature of IGBT. (2#) | |

| Failure code | Problem | Solution |
|-------------------------|-------------------------------------------------------------------------------|-----------------------------------------------------------------------|
| No Auto-Recovery | | |
| F3/F6 | Ceramic plate temperature sensor failure-short circuit. (F3 for 1#,F6 for 2#) | Check the connection or replace the ceramic plate temperature sensor. |
| F4/F7 | Ceramic plate temperature sensor failure-open circuit. (F4 for 1#,F7 for 2#) | |
| F5/F8 | Ceramic plate temperature sensor failure-invalid . (F5 for 1#,F8 for 2#) | |
| F9/FA | Temperature sensor of the IGBT failure. (short circuit/open circuit for 1#) | Replace the power board. |
| FC/FD | Temperature sensor of the IGBT failure. (short circuit/open circuit for 2#) | |

2) Specific Failure & Solution

| Failure | Problem | Solution A | Solution B |
|------------------------------------------------------------------|----------------------------------------------------------------------|-------------------------------------------------------------------------------|------------|
| The LED does not come on when unit is plugged in. | No power supplied. | Check to see if plug is secured tightly in outlet and that outlet is working. | |
| | The accessorial power board and the display board connected failure. | Check the connection. | |
| | The accessorial power board is damaged. | Replace the accessorial power board. | |
| | The display board is damaged. | Replace the display board. | |
| Some buttons can't work, or the LED display is not normal. | The display board is damaged. | Replace the display board. | |
| The Cooking Mode Indicator comes on, but heating does not start. | High temperature of the hob. | Ambient temperature may be too high. Air Intake or Air Vent may be blocked. | |
| | There is something wrong with the fan. | Check whether the fan runs smoothly; if not, replace the fan. | |
| | The power board is damaged. | Replace the power board. | |

| Failure | Problem | Solution A | Solution B |
|---------------------------------------------------------------------------------------------|----------------------------------------------------------|-----------------------------------------------------------------------------------------------------|------------------------------------------------------------|
| Heating stops suddenly during operation and the display flashes "U". | Pan Type is wrong. | Use the proper pot (refer to the instruction manual.) | Pan detection circuit is damaged, replace the power board. |
| | Pot diameter is too small. | | |
| | Cooker has overheated; | Unit is overheated. Wait for temperature to return to normal. Push "ON/OFF" button to restart unit. | |
| Heating zones of the same side (Such as the first and the second zone) would display "U". | The power board and the display board connected failure; | Check the connection. | |
| | The display board of communicate part is damaged. | Replace the display board. | |
| | The Main board is damaged. | Replace the power board. | |
| Fan motor sounds abnormal. | The fan motor is damaged. | Replace the fan. | |

The above are the judgment and inspection of common failures.

Please do not disassemble the unit by yourself to avoid any dangers and damages to the induction hob.

9. INSTALLATION

9.1 Selection of installation equipment

Cut out the work surface according to the sizes shown in the drawing.

For the purpose of installation and use, a minimum of 50mm space shall be preserved around the hole.

Be sure the thickness of the work surface is at least 30mm. Please select heat-resistant and insulated work surface material (Wood and similar fibrous or hygroscopic material shall not be used as work surface material unless impregnated) to avoid the electrical shock and larger deformation caused by the heat radiation from the hotplate. As shown below:



Note: The safety distance between the sides of the hob and the inner surfaces of the worktop should be at least 3mm.

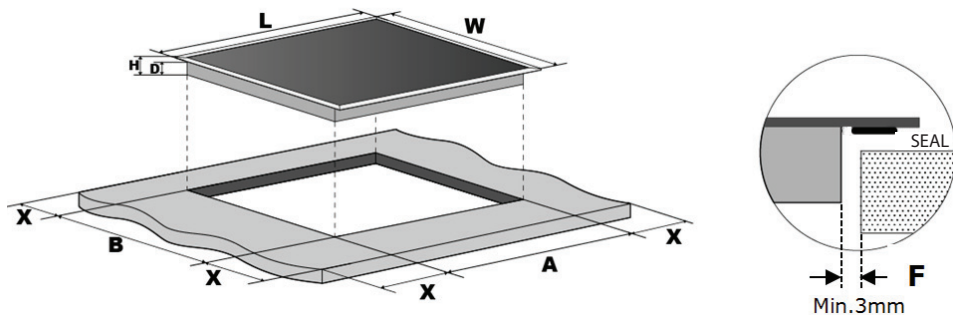

| L (mm) | W (mm) | H (mm) | D (mm) | A (mm) | B (mm) | X (mm) | F (mm) |
|--------|--------|--------|--------|--------------|--------------|---------|--------|
| 590 | 520 | 60 | 56 | 560 +4 +1 | 490 +4 +1 | 50 mini | 3 mini |

Under any circumstances, make sure the Induction cooker hob is well ventilated and the air inlet and outlet are not blocked. Ensure the Induction cooker hob is in good work state. As shown below.



Note: The safety distance between the hotplate and the cupboard above the hotplate should be at least 760 mm.

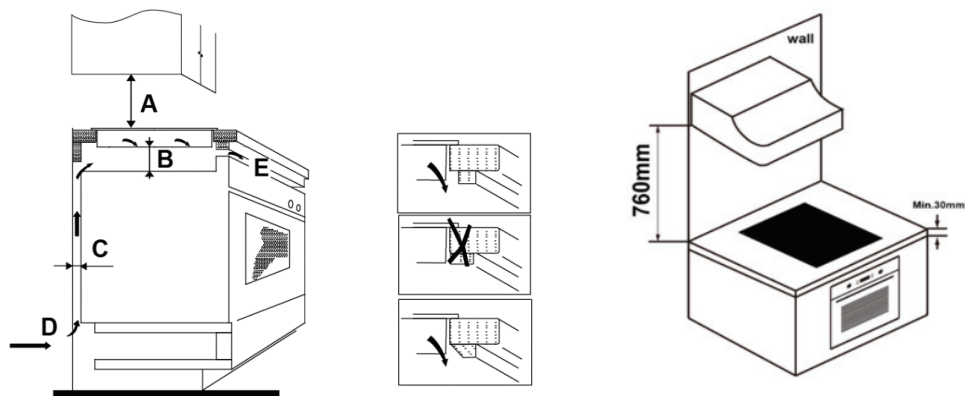

| A (mm) | B (mm) | C (mm) | D | E |
|--------|---------|---------|------------|---------------|
| 760 | 50 min. | 20 min. | Air intake | Air exit 5 mm |

WARNING: Ensuring Adequate Ventilation

Make sure the induction cooker hob is well ventilated and that air inlet and outlet are not blocked. In order to avoid accidental touch with the overheating bottom of the hob, or getting unexpected electric shock during working, it is necessary to put a wooden insert, fixed by screws, at a minimum distance of 50mm from the bottom of the hob. Follow the requirements below.

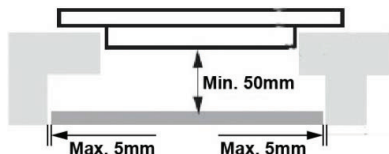

There are ventilation holes around outside of the hob. YOU MUST ensure these holes are not blocked by the worktop when you put the hob into position.



- Be aware that the glue that join the plastic or wooden material to the furniture, has to resist to temperature not below 150 °C, to avoid the unstuck of the paneling.
- The rear wall, adjacent and surrounding surfaces must therefore be able to withstand an temperature of 90 °C.

9.2 Before installing the hob, make sure that

- The work surface is square and level, and no structural members interfere with space requirements.
- The work surface is made of a heat-resistant and insulated material.
- If the hob is installed above an oven, the oven has a built-in cooling fan.
- The installation will comply with all clearance requirements and applicable standards and regulations.
- A suitable isolating switch providing full disconnection from the mains power supply is incorporated in the permanent wiring, mounted and positioned to comply with the local wiring rules and regulations. The isolating switch must be of an approved type and provide a 3 mm air gap contact separation in all poles (or in all active [phase] conductors if the local wiring rules allow for this variation of the requirements).
- The isolating switch will be easily accessible to the customer with the hob installed.
- You consult local building authorities and by-laws if in doubt regarding installation.
- You use heat-resistant and easy-to-clean finishes (such as ceramic tiles) for the wall surfaces surrounding the hob.

9.3 After installing the hob, make sure that

- The power supply cable is not accessible through cupboard doors or drawers.
- There is adequate flow of fresh air from outside the cabinetry to the base of the hob.
- If the hob is installed above a drawer or cupboard space, a thermal protection barrier is installed below the base of the hob.
- The isolating switch is easily accessible by the customer.

9.4 Before locating the fixing brackets

The unit should be placed on a stable, smooth surface (use the packaging). Do not apply force onto the controls protruding from the hob.

9.5 Adjusting the bracket position

Fix the hob on the work surface by screw 2 brackets on the bottom of hob(see picture) after installation. Adjust the bracket position to suit for different table top thickness.

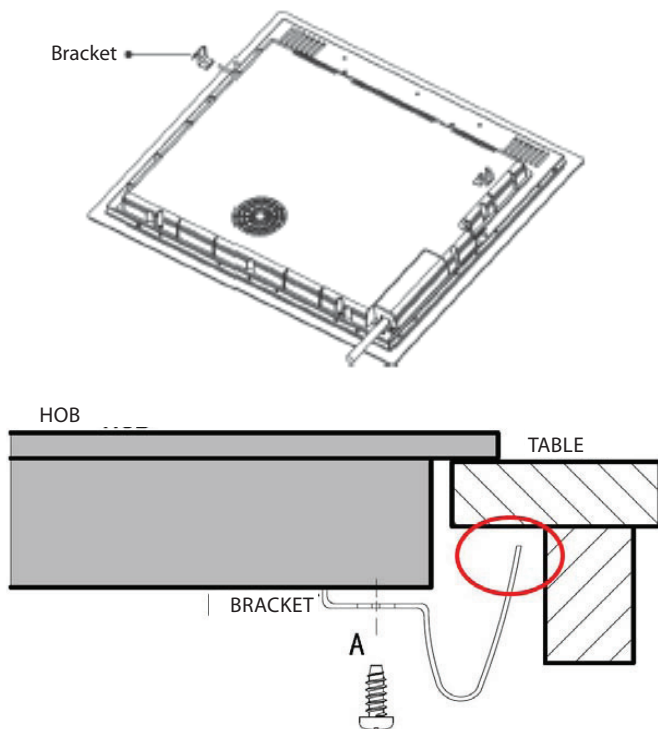



Under any circumstances, the brackets cannot touch with the inner surfaces of the worktop after installation (see picture).

9.6 Cautions

1. The induction hotplate must be installed by qualified personnel or technicians. We have professionals at your service. Please never conduct the operation by yourself.
2. The hob will not be installed directly above a dishwasher, fridge, freezer, washing machine or clothes dryer, as the humidity may damage the hob electronics
3. The induction hotplate shall be installed such that better heat radiation can be ensured to enhance its reliability.
4. The wall and induced heating zone above the table surface shall withstand heat.
5. In order to prevent any damage, the plastic or wooden kitchen material and the adhesive must be resistant to temperatures up to 150 °C.
6. A steam cleaner is not to be used.

9.7 Connecting the hob to the mains power supply



This hob must be connected to the mains power supply only by a suitably qualified person.

Before connecting the hob to the mains power supply, check that:

1. The domestic wiring system is suitable for the power drawn by the hob.
2. The voltage corresponds to the value given in the rating plate
3. The power supply cable sections can withstand the load specified on the rating plate.

To connect the hob to the mains power supply, do not use adapters, reducers, or branching devices, as they can cause overheating and fire.

The power supply cable must not touch any hot parts and must be positioned so that its temperature will not exceed 75°C at any point.



Check with an electrician whether the domestic wiring system is suitable without alterations. Any alterations must only be made by a qualified electrician.

| Model | Mains | Connection | Cable diameter | Cable | Protection calibre |
|-----------|--------------------|------------|----------------------|---------|--------------------|
| PHD 60 IP | 220-240V ~ 50/60Hz | 1Phase+1N | 3*1.5mm ² | H05RR-F | 1 x 16A |

This model includes a power cable with a 230 V electric plug.

- If the cable is damaged or to be replaced, the operation must be carried out by an after-sale agent with dedicated tools to avoid any accidents.
- If the appliance is being connected directly to the mains an omnipolar circuit-breaker must be installed with a minimum opening of 3mm between contacts.
- The installer must ensure that the correct electrical connection has been made and that it is compliant with safety regulations.
- The cable must not be bent or compressed.
- The cable must be checked regularly and replaced by authorised technicians only.
- The yellow/green wire of the power supply cable must be connected to the earth of both power supply and appliance terminals.
- The manufacturer cannot be held responsible for any accidents resulting from the use of an appliance which is not connected to earth, or with faulty earth connection continuity.
- If the appliance has a socket outlet, it must be installed so that the socket outlet is accessible.



The bottom surface and the power cord of the hob are not accessible after installation.

INSTRUCTIONS AND INFORMATION REGARDING THE DISPOSAL OF USED PACKAGING MATERIALS

Dispose of packaging material at a public waste disposal site.

DISPOSAL OF USED ELECTRICAL AND ELECTRONIC APPLIANCES



The meaning of the symbol on the product, its accessory or packaging indicates that this product shall not be treated as household waste. Please, dispose of this product at your applicable collection point for the recycling of electrical & electronic equipment waste. Alternatively in some states of the European Union or other European states you may return your products to your local retailer when buying an equivalent new product. The correct disposal of this product will help save valuable natural resources and help in preventing the potential negative impact on the environment and human health, which could be caused as a result of improper liquidation of waste. Please ask your local authorities or the nearest waste collection centre for further details. The improper disposal of this type of waste may fall subject to national regulations for fines.

For business entities in the European Union

If you wish to dispose of an electrical or electronic device, request the necessary information from your seller or supplier.

Disposal in other countries outside the European Union

If you wish to dispose of this product, request the necessary information about the correct disposal method from local government departments or from your seller.



This product meets all the basic EU regulation requirements that relate to it.

Changes to the text, design and technical specifications may occur without prior notice and we reserve the right to make these changes.

Original of this user manual is in czech language.

Manufacturer/Importer:
Fast ČR, a.s.
Praha 10, Černokostecká 2111
CZ-10000; CZECH REPUBLIC

PHILCO[®] 

**is a registered trademark used under license from
Electrolux Home Products., Inc.**