

Washing Machine

OWNER'S MANUAL

PHILCO



Famous for Quality the World Over

PLDS 106 DG

PLD 147 EG

PLDS 127 DG

PLDS 106 DGPL

PLD 147 EGPL

PLDS 127 DGPL

PLDS 106 DGHU

PLD 147 EGHU

PLDS 127 DGHU

**Dear customer,
Thank you for buying a PHILCO brand product. So that your appliance serves you well, please read all the instructions in this user's manual.**

CONTENTS

PART 1: SAFETY INSTRUCTIONS	2
Safety Instructions	6
PART 2: INSTALLATION	7
Product Description	7
Installation	8
PART 3: OPERATIONS.....	11
Quick Start	11
Before Each Washing.....	12
Detergent Dispenser.....	13
Control Panel	15
Programmes (Model: PLDS 106 DG / PLDS 106 DGPL / PLDS 106 DGHU).....	16
Programmes (Model: PLDS 127 DG / PLDS 127 DGPL / PLDS 127 DGHU).....	18
Programmes (Model: PLD 147 EG / PLD 147 EGPL / PLD 147 EGHU)	20
Programmes.....	22
Option	23
PART 4: MAINTENANCE	27
Cleaning and Care.....	27
Trouble Shooting.....	30
Customer service.....	31
Technical Specifications.....	31
PART 5: PRODUCT INFORMATION SHEET	32

Read This Manual

Use all instructions and explanations of the installation before use. Follow the instructions carefully. Keep the operation instructions handy for later use. If the application is sold or passed on then ensure that the new owner always receives those operation instructions.

PART 1: SAFETY INSTRUCTIONS

THIS APPLIANCE CAN BE USED BY CHILDREN AGED FROM 8 YEARS AND ABOVE AND BY PERSONS WITH REDUCED PHYSICAL, SENSORY OR MENTAL CAPABILITIES OR LACK OF EXPERIENCE AND KNOWLEDGE IF THEY HAVE BEEN GIVEN SUPERVISION OR INSTRUCTIONS CONCERNING USE OF THE APPLIANCE IN A SAFE WAY AND IF THEY UNDERSTAND THE HAZARDS INVOLVED.

CHILDREN MUST NOT PLAY WITH THE APPLIANCE.

CHILDREN YOUNGER THAN 3 YEARS OF AGE SHOULD BE PREVENTED FROM ACCESSING UNLESS THEY ARE UNDER PERMANENT SUPERVISION.

CLEANING AND USER MAINTENANCE CANNOT BE PERFORMED BY CHILDREN WITHOUT SUPERVISION.

IF THE SUPPLY CABLE GETS DAMAGED, HAVE IT REPLACED BY A SPECIALIZED SERVICE CENTRE IN ORDER TO AVOID DANGEROUS SITUATIONS. IT IS PROHIBITED TO USE AN APPLIANCE WITH THE SUPPLY CABLE DAMAGED.

FOR INFORMATION ON THE MAXIMUM DRY WEIGHT FOR WHICH THE APPLIANCE CAN BE USED, SEE PAGE 31 IN THE TECHNICAL DATA SECTION.

THE VENTILATION OPENINGS AT THE BOTTOM MUST NOT BE COVERED WITH CARPET.

THIS APPLIANCE IS INTENDED TO BE USED ONLY IN HOUSEHOLDS AND NOT IN SIMILAR PREMISES, SUCH AS:

- KITCHENETTES IN SHOPS, OFFICES AND OTHER WORKPLACES;
- APPLIANCES USED BY GUESTS IN HOTELS, MOTELS, AND OTHER ACCOMMODATION FACILITIES;
- APPLIANCES USED IN BED AND BREAKFAST FACILITIES;
- APPLIANCES USED IN CATERING AND OTHER SIMILAR NON-VENDING ENVIRONMENTS

ADDITIONAL INFORMATION

THIS APPLIANCE IS INTENDED FOR WASHING FABRICS FOR WHICH THE MANUFACTURER HAS RECOMMENDED SUCH TREATMENT.

ALWAYS USE PROGRAMMES ACCORDING TO THE FABRIC TYPE.

THE WASHING MACHINE COULD GET DAMAGED WHEN WASHING SHOES.

DO NOT USE TO WASH CARPETS.

USE ONLY DETERGENTS THAT ARE INTENDED FOR WASHING CLOTHES IN AN AUTOMATIC DRUM WASHING MACHINE.

SOFTENERS AND SIMILAR PRODUCTS SHOULD ALWAYS BE USED IN ACCORDANCE WITH THEIR INSTRUCTION FOR USE.

- IF THE SUPPLY CORD GETS DAMAGED, IT MUST BE REPLACED BY THE MANUFACTURER, ITS SERVICE AGENT OR A SIMILARLY QUALIFIED PERSON.
- THE APPLIANCE SHOULD BE CONNECTED TO THE WATER SUPPLY AND DRAIN USING NEW HOSES, NOT USING HOSES THAT HAVE ALREADY BEEN USED.
- ALWAYS DISCONNECT THE APPLIANCE FROM THE MAINS BEFORE PERFORMING ANY MAINTENANCE.
- THE POWER CORD PLUG MUST BE CONNECTED TO A GROUNDED THREE-POLE ELECTRIC OUTLET.
- NEVER USE A POWER OUTLET WITH A RATED VOLTAGE THAT IS DIFFERENT FROM THE APPLIANCE'S VOLTAGE.
- DO NOT USE EXTENSION CORD TO CONNECT THE MACHINE TO THE POWER OUTLET.
- THE APPLIANCE, THE POWER CORD OR THE ELECTRIC OUTLET MUST NOT LIE IN, TOUCH OR BE SUBMERGED IN WATER OR ANY OTHER LIQUID TO AVOID ELECTRICAL HAZARDS.
- THE APPLIANCE MUST NOT STAND ON THE POWER CORD.
- THE POWER CORD MUST NOT BE EXCESSIVELY OR DANGEROUSLY BENT OR COMPRESSED DURING INSTALLATION OR OPERATION.
- THE CONTROLS AND DOOR OF THE APPLIANCE ARE NOT TO BE PLAYED WITH.
- THE GLASS DOOR OF THE APPLIANCE CAN GET HOT DURING OPERATION.

APPLIANCE INSTALLATION

- THIS APPLIANCE IS INTENDED FOR INTERIOR USE ONLY.
- THIS APPLIANCE IS INTENDED TO BE BUILT-IN.
- THE ELECTRIC OUTLET THAT THE POWER CORD IS CONNECTED TO MUST BE EASILY ACCESSIBLE AFTER THE APPLIANCE HAS BEEN INSTALLED.
- REMOVE ALL PACKAGING MATERIALS AND SAFETY TRANSPORT BOLTS BEFORE USING THE APPLIANCE. OTHERWISE THE APPLIANCE OR ITS SURROUNDINGS MIGHT GET SERIOUSLY DAMAGED.
- THE APPLIANCE, THE POWER CORD OR THE ELECTRIC OUTLET MUST NOT LIE IN, TOUCH OR BE SUBMERGED IN WATER OR ANY OTHER LIQUID TO AVOID ELECTRICAL HAZARDS.
- THE PACKAGING MATERIALS MUST BE DISPOSED OF IN A PROPER MANNER.
- DO NOT LIFT OR HANDLE THE APPLIANCE WHEN HOLDING ITS DOOR, CONTROLS, THE UPPER BOARD, HOSES OR POWER CORD.
- THE APPLIANCE MUST BE INSTALLED ONTO A FIRM AND EVEN SURFACE.
- AFTER YOU PLACE THE APPLIANCE, MAKE SURE IT IS LEVEL IN ALL DIRECTIONS USING A SPIRIT LEVEL.

PLEASE READ THOSE SAFETY PRECAUTIONS CAREFULLY AND STORE THEM FOR FUTURE REFERENCE.

■ Safety Instructions

For your safety, the information in this manual must be followed to minimize the risk of fire or explosion, electric shock, or to prevent property damage, personal injury or loss of life.

Explanation of the symbols:

Warning!

This combination of symbol and signal word indicates a potentially dangerous situation which may result in death or serious injuries unless it's avoided.

Caution!

This combination of symbol and signal word indicates a potentially dangerous situation which may result in slight or minor injuries or damage to property and the environment.

Note!

This combination of symbol and signal word indicates a potentially dangerous situation which may result in slight or minor injuries.

Packaging/Old appliance



This marking indicates that this product should not be disposed with other household wastes throughout the EU. To prevent possible harm to the environment or human health from uncontrolled waste disposal, recycle it responsibly to promote the sustainable reuse of material resources. To return your used device, please use the collection systems or contact the retailer where the product was purchased. They return and can take this product for environmental safe recycling.

PART 2: INSTALLATION

■ Product Description

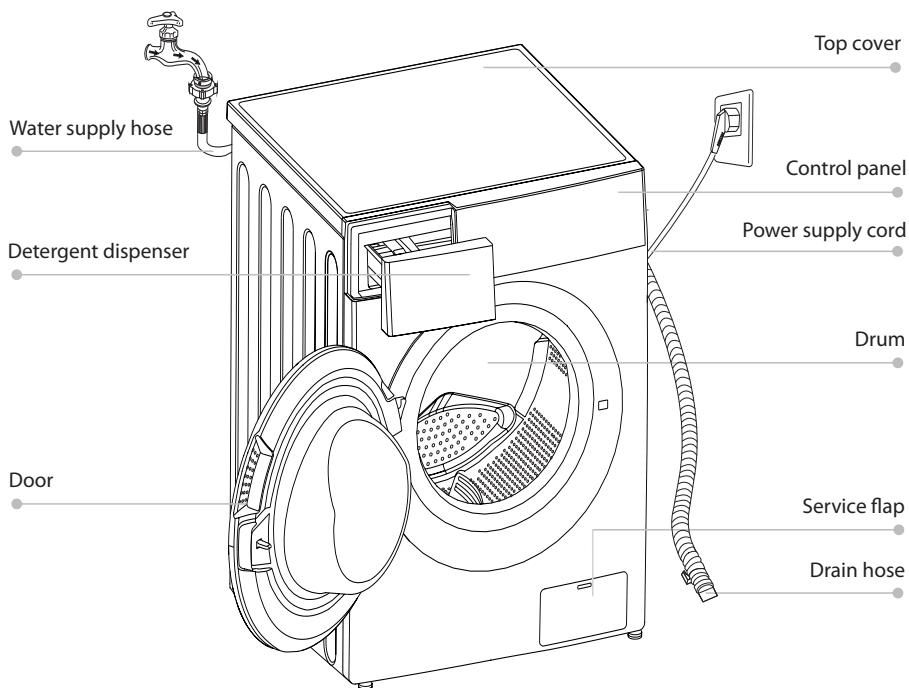

Note!

- The product picture is for illustration only, please refer to real product as reference.

Accessories



4 x Cover capsg



1 x Supply hose
cold water



1 x Owner's
manual

■ Installation

Installation area

⚠ Warning!

- Stability is important to prevent the product from wandering! Make sure the machine is standing leveled and stable.
- Make sure that the product does not stand onto the power cord.
- Make sure to maintain the minimum distances from the walls as shown in the picture.

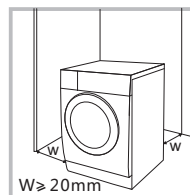

Before installing the machine, the location characterized as follows shall be selected:

1. Rigid, dry, and level surface.
2. Avoid direct sunlight.
3. Sufficient ventilation.
4. Room temperature is above 0°C.
5. Keep far away from the heat sources such as coal or gas burning appliances.

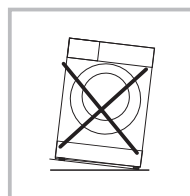

Unpacking the washing machine

⚠ Warning!

- Packaging material (e.g. Films, Styrofoam) can be dangerous for children.
 - There is a risk of suffocation ! Keep all packaging well away from children.
1. Remove the cardboard box and styrofoam packing.
 2. Lift the washing machine and remove the base packaging. Make sure the small triangle foam (a) is removed with the bottom packaging together. If not, lay the unit down on the side surface and remove it manually.
 3. Remove the tape securing the power supply cord and drain hose.
 4. Remove the inlet hose from the drum.

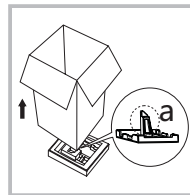

Remove transport bolts

⚠ Warning!

- You must remove the transport bolts from the backside before using the product.



Loosen the 4 transport bolts with a spanner.

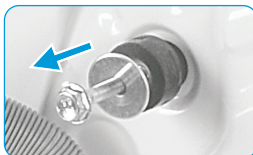

Remove the bolts including the rubber parts and keep them for future use.

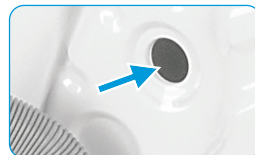

Close the holes using the cover caps.

Levelling the washing machine

Warning!

- The lock nuts on all four feet must be screwed tightly against the housing.
1. Loosen the lock nut.
 2. Turn the foot until it reaches the floor.
 3. Adjust the legs and lock the nuts with a spanner. Make sure the machine is level and steady.

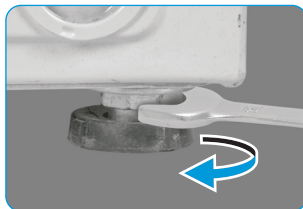

Connect the water supply hose

Warning!

To prevent leakage or water damage, follow the instructions in this chapter

- Do not kink, crush or modify water inlet hose.



Connect the water supply hose to the water inlet valve and a water tap with cold water as indicated.



Note!

- Connect manually, do not use tools. Check if the connections are tight.

Drain Hose

Warning!

- Do not kink or protract the drain hose.
- Position drain hose properly ,otherwise damage might result of water leakage.

There are two ways to place the end of drain hose:

1. Put it into the water trough.

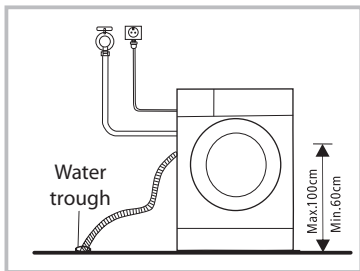

2. Connect it to the branch drain pipe of the trough.

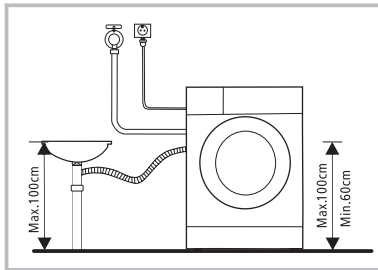

PART 3: OPERATIONS

■ Quick Start

⚠ Caution!

- Before washing, please make sure the washing machine is installed properly.
- Your appliance was thoroughly checked before it left the factory. To remove any residual water and to neutralize potential odors, it's recommended to clean your appliance before first use. For this reason, start the Cotton program at 90°C without laundry and detergent.

1. Before Washing

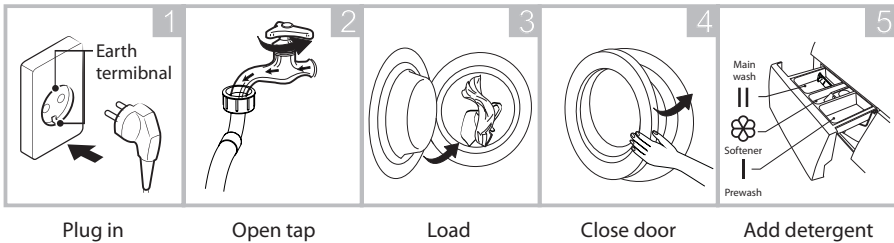

📌 Note!

- Detergent need to be added in compartment I if the pre-wash function is selected.

2. Washing

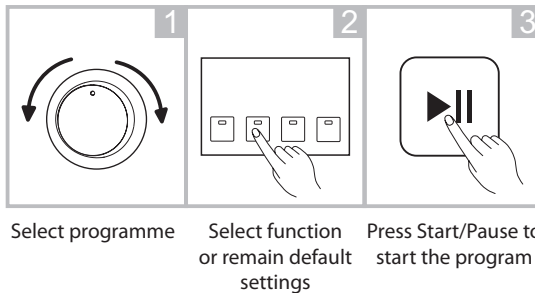

3. After Washing

The door lock and the [Start / Pause] lights flash with the buzzer beeping or two small points flash on the digital screen.

■ Before Each Washing

- The ambient temperature of the washing machine should be 5-40°C. If used under 0°C, the inlet valve and draining system may be damaged. If the machine is installed under freezing conditions, it should be transferred to normal ambient temperature to ensure the water supply hose and drain hose can unfreeze before use.
- Please check your laundry care labels and the detergent use instructions before wash. Use non-foaming or less-foaming detergent suitable for machine washing properly.

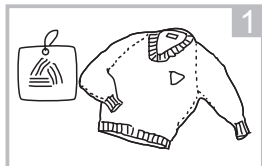

Check the care label

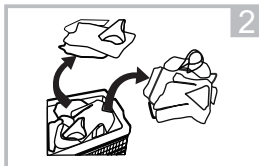

Sort laundry according to color and textile type

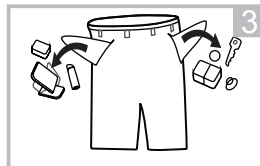

Take all items out of the pockets

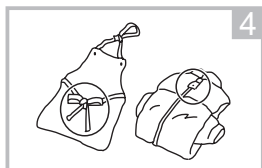

Tie together long textile strips and belts, close zips and button

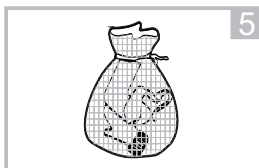

Put small items into a laundry bag

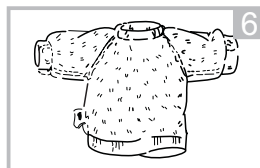



Turn easy-pilling and long-pile fabric inside out

Warning!

- Do not wash or dry articles that have been cleaned in, washed in, soaked in, or dabbed with combustible or explosive substances like wax, oil, paint, gasoline, alcohol, kerosene, and other flammable materials.
- Washing single clothes items may easily create big eccentricity and cause alarm due to unbalance. Therefore it is suggested to add one or two more laundry items to the wash so that spin can be done smoothly.





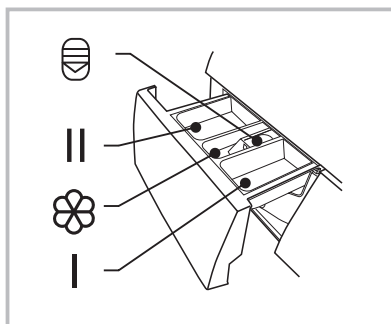



■ Detergent Dispenser









- I Pre wash
- II Main wash
-  Softener
-  Release button to pull out the dispenser



Caution!

- Detergent only need to be added in "compartment I" after selecting pre-wash function.

Programme	I	II	
 Cotton(Cold)	○	●	○
 Cotton (20°C)	○	●	○
 Cotton (40°C)	○	●	○
 Cotton (60°C)	○	●	○
 Jeans	○	●	○
 Delicate		●	○
 ECO 40-60		●	○
 Spin Only			

Programme	I	II	
 Rinse&Spin			○
 Heat Wash 90°C	○	●	○
 Mix (60°C)	○	●	○
 Mix (40°C)	○	●	○
 Mix (20°C)	○	●	○
 Rapid 45'	○	●	○
 Quick 15'		●	○

● Means must ○ Means optional

Detergent Recommendation

Recommended washing detergent	Wash cycles	Washing temp.	Type of laundry and textile
Heavy-duty detergent with bleaching agents and optical brighteners	Cotton, ECO 40-60	30/40/60	White laundry made from boil-proof cotton or linen
Colour detergent without bleaching agent and optical brighteners	Cotton, ECO 40-60	Cold/20/30/40	Coloured laundry made from cotton or linen
Color or mild detergent without optical brighteners	Delicate, Mix	Cold/20/40	Coloured laundry made from easy care fibres or synthetic materials
Mild washing detergent	Delicate	Cold/40	Delicate textiles, silk, viscose

Note!

- Agglomerating or ropy detergent or additive can be diluted in some water before pouring it into the detergent dispenser, to avoid its inlet to get blocked and thus cause a water overflow.
- Please choose the suitable type of detergent to get a maximum of washing performance and a minimum of water and energy consumption
- To achieve the best cleaning result a proper detergent dosing is important.
- Use a reduced detergent amount if the drum is not filled completely.
- Always adjust the amount of detergent to the water hardness, if your tap water is soft, use less detergent.
- Dose according to how dirty your laundry is, less dirty clothes require less detergent.
- Highly concentrated (compact detergent) requires particularly accurate dosing.

Following symptoms are a sign of detergent overdosing:

- heavy foam formation
- poor washing and rinsing result

Following symptoms are a sign of detergent underdosing:

- laundry turns grey
- built-up of limescale deposits on the drum, the heating element and/or the laundry

Control Panel

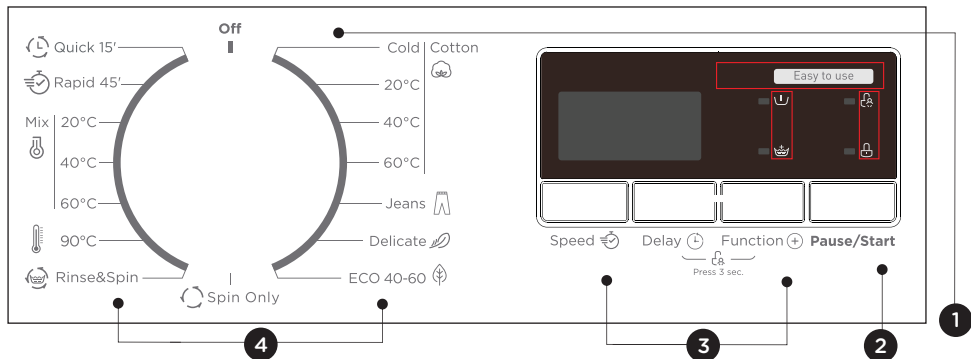

1 On/Off

Turn the appliance on and off.

2 Start/Pause

Start or pause your programme.

3 Option

This allows you to select additional functions and will light when selected.















4 Programmes

Available according to the laundry type.

5 Display







The display shows settings, estimated remaining time, options and status messages.

■ Programmes (Model: PLDS 106 DG / PLDS 106 DGPL / PLDS 106 DGHU)

Programme	Load (kg)	Display Time
	6.0	6.0
 Cotton (Cold)	6.0	2:20
 Cotton (20°C)	6.0	2:20
 Cotton (40°C)	6.0	2:40
 Cotton (60°C)	6.0	2:45
 Jeans	6.0	1:45
 Delicate	2.5	0:50
 ECO 40-60	6.0	3:18
 Spin Only	6.0	0:12
 Rinse&Spin	6.0	0:20
 Heat Wash 90°C	6.0	2:17
 Mix (60°C)	6.0	1:30
 Mix (40°C)	6.0	1:20
 Mix (20°C)	6.0	1:00
 Rapid 45'	2.0	0:45
 Quick 15'	2.0	0:15















Note!

- The parameters in this table are only for user's reference. The actual parameters maybe different with the parameters in above mentioned table.

PLDS 106 DG / PLDS 106 DGPL / PLDS 106 DGHU							
Cycle	Normal capacity in kg	Temperature Setting	Cycle duration in hours and minutes	Energy consumption in kWh/operalling cycle	Water consumption in liter/operalling cycle	Higher temperature °C	Residual moisture in %/spin speed
 Quick 15'	2.0	Cold	0:15	0.035	31	Cold	70%/800
 Cotton (20°C)	6.0	20	2:20	0.426	58	20	65%/1000
 Cotton (40°C)	6.0	40	2:40	0.871	58	40	65%/1000
 Mix (20°C)	6.0	20	1:00	0.239	58	20	65%/1000
 Cotton (60°C)	6.0	60	2:45	1.28	58	60	65%/1000
 ECO 40-60	6.0	-	3:48	0.850	52.5	39	61%/1000
	3.0	-	2:54	0.544	38.7	31	62%/1000
	1.5	-	2:54	0.401	32.6	27	65%/1000







- The above data is for reference only, and the data may change due to different actual use conditions.
- The values given for programmes other than the ECO 40-60 programme and the Wash and Dry cycle are indicative only.
- The new EU energy efficiency class is D Energy test program: ECO 40-60; Other as the default.
Half load for 6.0Kg machine: 3.0Kg.
Quarter load for 6.0Kg machine: 1.5Kg.

■ Programmes (Model: PLDS 127 DG / PLDS 127 DGPL / PLDS 127 DGHU)

Programme	Load (kg)	Display Time
	7.0	7.0
 Cotton (Cold)	7.0	2:20
 Cotton (20°C)	7.0	2:20
 Cotton (40°C)	7.0	2:40
 Cotton (60°C)	7.0	2:45
 Jeans	7.0	1:45
 Delicate	2.5	0:50
 ECO 40-60	7.0	3:28
 Spin Only	7.0	0:12
 Rinse&Spin	7.0	0:20
 Heat Wash 90°C	7.0	2:17
 Mix (60°C)	7.0	1:30
 Mix (40°C)	7.0	1:20
 Mix (20°C)	7.0	1:00
 Rapid 45'	2.0	0:45
 Quick 15'	2.0	0:15















Note!

- The parameters in this table are only for user's reference. The actual parameters maybe different with the parameters in above mentioned table.

PLDS 127 DG / PLDS 127 DGPL / PLDS 127 DGHU							
Cycle	Normal capacity in kg	Temperature Setting	Cycle duration in hours and minutes	Energy consumption in kWh/operalling cycle	Water consumption in liter/operalling cycle	Higher temperature °C	Residual moisture in %/spin speed
 Quick 15'	2.0	Cold	0:15	0.035	31	Cold	70%/800
 Cotton (20°C)	7.0	20	2:20	0.438	65	20	65%/1000
 Cotton (40°C)	7.0	40	2:40	0.929	65	40	65%/1000
 Mix (20°C)	7.0	20	1:00	0.251	65	20	65%/1000
 Cotton (60°C)	7.0	60	2:45	1.385	65	60	65%/1000
 ECO 40-60	7.0	-	3:28	0.940	55.3	39	62%/1200
	3.5	-	2:42	0.590	41.5	35	62%/1200
	2.0	-	2:42	0.435	35.6	30	62%/1200







- The above data is for reference only, and the data may change due to different actual use conditions.
- The values given for programmes other than the ECO 40-60 programme and the Wash and Dry cycle are indicative only.
- The new EU energy efficiency class is D Energy test program: ECO 40-60; Other as the default.
Half load for 7.0Kg machine: 3.5Kg.
Quarter load for 7.0Kg machine: 2.0Kg.

■ Programmes (Model: PLD 147 EG / PLD 147 EGPL / PLD 147 EGHU)

Programme	Load (kg)	Display Time
	7.0	7.0
 Cotton (Cold)	7.0	2:20
 Cotton (20°C)	7.0	2:20
 Cotton (40°C)	7.0	2:40
 Cotton (60°C)	7.0	2:45
 Jeans	7.0	1:45
 Delicate	2.5	0:50
 ECO 40-60	7.0	3:23
 Spin Only	7.0	0:12
 Rinse&Spin	7.0	0:20
 Heat Wash 90°C	7.0	2:17
 Mix (60°C)	7.0	1:30
 Mix (40°C)	7.0	1:20
 Mix (20°C)	7.0	1:00
 Rapid 45'	2.0	0:45
 Quick 15'	2.0	0:15

Note!

- The parameters in this table are only for user's reference. The actual parameters maybe different with the parameters in above mentioned table.

PLD 147 EG / PLD 147 EGPL / PLD 147 EGHU							
Cycle	Normal capacity in kg	Temperature Setting	Cycle duration in hours and minutes	Energy consumption in kWh/operalling cycle	Water consumption in liter/operalling cycle	Higher temperature °C	Residual moisture in %/spin speed
 Quick 15'	2.0	Cold	0:15	0.035	31	Cold	70%/800
 Cotton (20°C)	7.0	20	2:20	0.438	65	20	65%/1000
 Cotton (40°C)	7.0	40	2:40	0.929	65	40	65%/1000
 Mix (20°C)	7.0	20	1:00	0.251	65	20	65%/1000
 Cotton (60°C)	7.0	60	2:45	1.385	65	60	65%/1000
 ECO 40-60	7.0	-	3:28	1.074	55.5	39	53%/1400
	3.5	-	2:42	0.700	42.0	35	53%/1400
	2.0	-	2:42	0.460	34.6	24	53%/1400

- The above data is for reference only, and the data may change due to different actual use conditions.
- The values given for programmes other than the ECO 40-60 programme and the Wash and Dry cycle are indicative only.
- The new EU energy efficiency class is E Energy test program: ECO 40-60; Other as the default.
Half load for 7.0Kg machine: 3.5Kg.
Quarter load for 7.0Kg machine: 2.0Kg.

- 1) The highest temperature reached by the laundry in the wash cycle for at least 5 minutes.
- 2) Residual moisture after the wash cycle in water content percent and the spin speed at which this was achieved.
- 3) The ECO 40-60 programme is able to clean normally soiled cotton laundry declared to be washable at 40°C or 60°C, together in the same cycle. This programme is used to assess the compliance with the regulation (EU) 2019/2023.

The most efficient programmes in terms of energy consumption are generally those that perform at lower temperatures and longer duration.

Loading the household washing machine up to the capacity indicated for the respective programmes will contribute to energy and water savings.











Noise and remaining moisture content are influenced by the spinning speed: the higher the spinning speed in the spinning phase, the higher the noise and the lower the remaining moisture content.

Caution!



























- If there is any break in the power supply while the machine is operating, a special memory stores the selected programme. The machine will continue the programme when the power supply is re-established.

Programmes

Programmes are available according to the laundry type.

 Cotton	Hard-wearing textiles, heat-resistant textiles made of cotton or linen.
 Heat Wash 90°C	Washing the baby's clothes, it can make the baby's wear cleaner and make the rinse performance better to protect the baby skin.
 Rapid 45'	Washing few and not very dirty clothes quickly.
 Mix	Mixed load consisting of textiles made of cotton and synthetics.
 Jeans	Specially for jeans.
 Quick 15'	Extra short programme approx, suitable for lightly soiled washing as a small amounts of laundry.
 Spin Only	Extra spin with selectable spin speed.
 Rinse&Spin	Extra rinse with spin.
 ECO 40-60	Default 40°C, not selectable, suitable for laundry washing at about 40°C-60°C.
 Delicate	For delicate, washable textiles, e.g. made of silk, satin, synthetic fibres or blended fabrics.

■ Option

Cycle	Default Temp (°C)	Additional functions
 Cotton (Cold)	Cold	Delay, U, 
 Cotton (20°C)	20	Delay, U, 
 Cotton (40°C)	40	Delay, U, 
 Cotton (60°C)	60	Delay, U, 
 Jeans	60	Delay, U, 
 Delicate	30	Delay, 
 ECO 40-60	60	Delay
 Spin Only	--	Delay
 Rinse&Spin	--	Delay, 
 Heat Wash 90°C	90	Delay, U, 
 Mix (60°C)	60	Delay, U, 
 Mix (40°C)	40	Delay, U, 
 Mix (20°C)	20	Delay, U, 
 Rapid 45'	40	Delay, U, 
 Quick 15'	Cold	Delay

Note!

- For the maximum spin speed, program time, and other details of the ECO 40-60 program, please refer to the content on the Product Fiche page.
- The table shows which cycle offers which options for adjustment. If an adjustment is not possible for a cycle.

Speed

The speed is:











1000: 0-400-600-800-1000 1200: 0-400-600-800-1000-1200

1400: 0-400-600-800-1000-1200-1400

Model:















PLDS 106 DG / PLDS 106 DGPL / PLDS 106 DGHU

PLD 147 EG / PLD 147 EGPL / PLD 147 EGHU

Programme	Default Speed (rpm)			
	1000	1200	1400 (7kg)	1400 (8kg)
 Cotton(Cold)	1000	1000	1000	1000
 Cotton (20°C)	1000	1000	1000	1000
 Cotton (40°C)	1000	1000	1000	1000
 Cotton (60°C)	1000	1000	1000	1000
 Jeans	1000	1000	1000	1000
 Delicate	600	600	600	600
 ECO 40-60	1000	1150	1400	1350
 Spin Only	1000	1000	1000	1000
 Rinse&Spin	1000	1000	1000	1000
 Heat Wash 90°C	1000	1000	1000	1000
 Mix (60°C)	1000	1000	1000	1000
 Mix (40°C)	1000	1000	1000	1000
 Mix (20°C)	1000	1000	1000	1000
 Rapid 45'	800	800	800	800
 Quick 15'	800	800	800	800

Model:

PLDS 127 DG / PLDS 127 DGPL / PLDS 127 DGHU

Programme	Default Speed (rpm)
	1200
 Cotton(Cold)	1000
 Cotton (20°C)	1000
 Cotton (40°C)	1000
 Cotton (60°C)	1000
 Jeans	1000
 Delicate	600
 ECO 40-60	1200
 Spin Only	1000
 Rinse&Spin	1000
 Heat Wash 90°C	1000
 Mix (60°C)	1000
 Mix (40°C)	1000
 Mix (20°C)	1000
 Rapid 45'	800
 Quick 15'	800

Pre Wash: The Prewash function can get an extra wash before main wash, it is suitable for washing the dust rises to surface of the clothes; You need to put detergent into the Case (I) when select it.

Delay: Delay function can be set with this button, the delaying time is 0-24H.

Speed: It can be set the spin speed to press the button repeatedly.

Extra Rinse: The laundry will undergo extra rinse once after you select it.



Child Lock

To avoid mis operation by children.



Choose the Programme



Start



Press [Delay] and [Function] 3 sec. till buzzer beep.



Caution!

- Press the two button 3sec. also to be released the function.
- The "Child Lock" will lock all buttons except [OFF].
- If you want to change the program on child lock condition, you should unlock the child lock first, then rotate the knob to OFF position, finally choose the program you want.

PART 4: MAINTENANCE

■ Cleaning and Care

Warning!

- Always unplug the appliance and close the water tap before cleaning and maintenance.

Cleaning the Cabinet

Proper maintenance on the washing machine can extend its working life. The surface can be cleaned with diluted non-abrasive neutral detergents when necessary. If there is any water overflow, use a cloth to wipe it off immediately. Never use sharp items to clean the appliance.

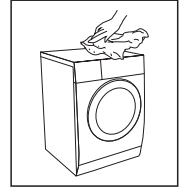

Caution!

- Never use abrasive or caustic agents, formic acids or its diluted solvents or similar substances, like alcohol or chemical products.

Cleaning the Drum

Any rust stains left inside the drum by metal articles must be removed immediately using chlorine-free detergents. Never use steel wool for cleaning the drum!

Note!

- Keep any laundry away from the machine while cleaning the drum.

Cleaning the Door Seal and Glass

Wipe the glass and seal after each wash to remove lint and stains. If lint builds up it can cause leakages. Remove any coins, buttons and other objects from the seal after each wash. Clean the Door Seal and Glass every month to ensure the normal operation of the appliance.

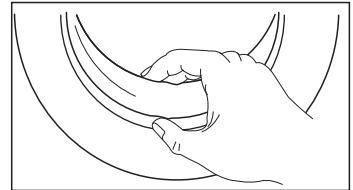

Cleaning the Inlet Filter



Note!

- Diminishing water flow is a sign that the filter need to be cleaned.
1. Close the tap and remove the water supply hose from it.
 2. Clean the filter with a brush.
 3. Unscrew the water supply hose from the backside of the machine. Pull out the filter with long nose pliers.
 4. Use a brush to clean the filter.
 5. Reinstall the filter to the water inlet and reconnect the water supply hose.
 6. Clean the Inlet filter every 3 months to ensure the normal operation of the appliance.

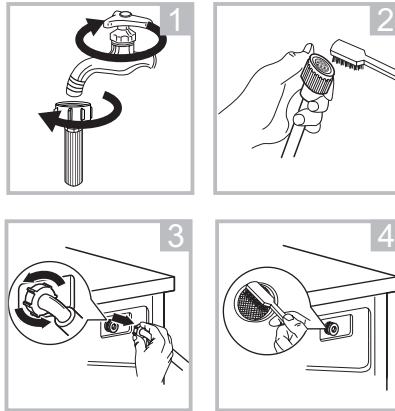

Clean The Detergent Dispenser

1. Press down the release  on the softener cover and pull the dispenser drawer out of the recess. Clean the inside of the recess with a brush.
2. Lift the softener cover off the dispenser drawer and wash both items with water.
3. Restore the softener cover and push the drawer back into the recess.

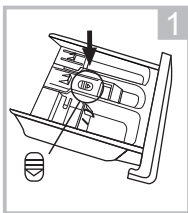

Press the release and remove the dispenser drawer

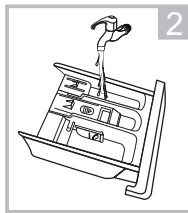

Clean the dispenser drawer and the softener cover under water

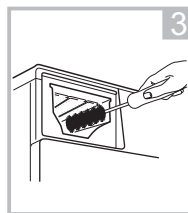

Clean the recess with an soft brush

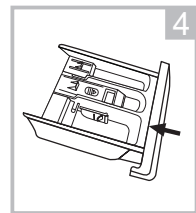

Insert the dispenser drawer

Note!

- Do not use abrasive or caustic agents to clean plastic parts.
- Clean the detergent dispenser every 3 months to ensure the normal operation of the appliance.

Cleaning the Drain Pump Filter

Warning!

- Make sure that the machine has finished the washing cycle and is empty. Switch it off and unplug it before cleaning the drain pump filter.
- Be careful of hot water. Allow the water to cool down. Risk of scalding!
- Clean the filter periodically every 3 months to ensure the normal operation of the appliance.

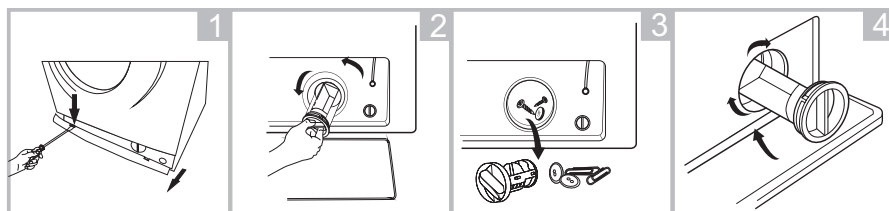

1 Open the Service filter

2 Open the filter by turning to the counter clockwise

3 Remove extraneous matter

4 Close the lower cover cap

Caution!

- When the appliance is in use and depending on the programme selected there can be hot water in the pump. Never remove the pump cover during a wash cycle, always wait until the appliance has finished the cycle, and is empty. When replacing the cover, ensure it is securely re-tightened.

■ Trouble Shooting

Whenever there is a problem with the appliance, check if you can solve it following the tables below. If the problem persists, please contact the customer service.

Description	Reason	Solution
Washing machine cannot start up.	Door is not closed properly.	Restart after the door is closed. Check if the clothes is stuck.
Door can't be opened.	Washer's safety protection design is working.	Disconnect the power, restart the product.
Water leakage.	The connection between inlet pipe or outlet hose is not tight.	Check and fasten water pipes. Clean up outlet hose.
Detergent residues in the box.	Detergent is dampened or agglomerated.	Clean and wipe the detergent box.
Indicator or display does not light.	Disconnect the power. PC board or harness has connection problem.	Check if the power is shut down and the power plug is connected correctly.
Abnormal noise.		Check if the fixing (bolts) have been removed. Check it's installed on a solid and level floor.

LED display models:

Description	Reason	Solution
E30	Door is not closed properly.	Restart after the door is closed. Check if the clothes is stuck.
E10	Water injecting problem while washing.	Check if the water pressure is too low. Straighten the water pipe. Check if the inlet valve filter is blocked.
E21	Overtime water draining.	Check if the drain hose is blocked.
E12	Water overflow.	Restart the washer.
EXX	Others	Please try again first, call up service line if there are still troubles.

Note!

- After the check, activate the appliance. If the problem occurs or the display shows other alarm codes again, contact the service.

Customer service

Spare part for your appliance are available for a minimum of 10 years.

In case of questions please contact our customer service at:

Warning!

Risk of electric shock

- Never try repair an appliance which is defective or presumed to be defective. You may put your own and future users' lives in danger. Only authorised specialists are allowed to carry out this repair work.
- Improper repair will void the warranty and subsequent damages can't be recognized!

Transport

IMPORTANT STEPS WHEN MOVING THE APPLIANCE

- Unplug the appliance and close the water inlet tap.
- Check, if the door and the detergent dispenser are closed properly.
- Remove the water inlet pipe and the outlet hose from the house installations.
- Let the water drain completely from the appliance (see "Maintenance Cleaning the drain pump filter")
- Important: Re-install the 4 transport bolts in the back of the appliance.
- This appliance is heavy. Transport with care. Never hold any protruding part of the machine when lifting. The machine door cannot be used as a handle.

Technical Specifications

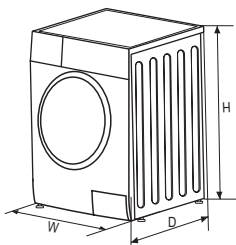

Power Supply	220 - 240V ~, 50Hz			
MAX. Current	10 A			
Standard Water Pressure	0.05MPa~1MPa			
Model	Washing Capacity	Dimension (W/D/H) mm	Net Weight	Rated Power
PLDS 106 DG / PLDS 106 DGPL / PLDS 106 DGHU	6.0kg	595/400/850	52kg	2050W
PLD 147 EG / PLD 147 EGPL / PLD 147 EGHU	7.0kg	595/495/850	60kg	2050W
PLDS 127 DG / PLDS 127 DGPL / PLDS 127 DGHU	7.0kg	595/400/850	55kg	2050W

PART 5: PRODUCT INFORMATION SHEET

Product Information Sheet

PHILCO 

COMMISSION DELEGATED REGULATION (EU) 2019/2016

Supplier's name or trademark: PHILCO

Supplier's address: FAST ČR, a.s., U Sanitasu 1621, 25101 Říčany, Czech Republic

Model identifier: PLDS 106 DG / PLDS 106 DGPL / PLDS 106 DGHU

General product parameters: Washing Machine

Parameter	Value		Parameter	Value	
Rated capacity (kg)	6.0		Dimensions in cm	Height	85
				Width	60
				Depth	40
EEL _w	80.0		Energy efficiency class*	D	
Washing efficiency index	1.031		Rinsing effectiveness (g/kg)	5.0	
Energy consumption in kWh per cycle, based on the eco 40-60 programme. Actual energy consumption will depend on how the appliance is used.	0.648		Water consumption in litre per cycle, based on the eco 40-60 programme. Actual water consumption will depend on how the appliance is used and on the hardness of the water.	43	
Maximum temperature inside the treated textile (°C)	Rated capacity	39	Remaining moisture content (%)	62.9	
	Half	31			
	Quarter	27			
Spin speed (rpm)	Rated capacity	1000	Spin-drying efficiency class	C	
	Half	1000			
	Quarter	1000			
Programme duration (h:min)	Rated capacity	3:18	Type	Free-standing	
	Half	2:36			
	Quarter	2:36			
Airborne acoustical noise emissions in the spinning phase (dB(A) re 1 pW)	80		Airborne acoustical noise emission class (spinning phase)	C	

Off-mode (W)	0.50	Standby mode (W)	1.00
Delay start (W) (if applicable)	4.00	Networked standby (W) (if applicable)	-
Minimum duration of the guarantee offered by the supplier: 24 months			
This product has been designed to release silver ions during the washing cycle		No	
Additional information:			
Weblink to the supplier's website, where the information in point 9 of Annex II to Commission Regulation (EU) 2019/2023 is found: www.philco.cz			

* A (highest efficiency) to G (lowest efficiency)

Product Information Sheet

PHILCO 

COMMISSION DELEGATED REGULATION (EU) 2019/2016

Supplier's name or trademark: PHILCO

Supplier's address: FAST ČR, a.s., U Sanitasu 1621, 25101 Říčany, Czech Republic

Model identifier: PLD 147 EG / PLD 147 EGPL / PLD 147 EGHU

General product parameters: Washing Machine

Parameter	Value		Parameter	Value	
Rated capacity (kg)	7.0		Dimensions in cm	Height	85
				Width	60
				Depth	50
EE _w	91.0		Energy efficiency class*	E	
Washing efficiency index	1.031		Rinsing effectiveness (g/kg)	5.0	
Energy consumption in kWh per cycle, based on the eco 40-60 programme. Actual energy consumption will depend on how the appliance is used.	0.784		Water consumption in litre per cycle, based on the eco 40-60 programme. Actual water consumption will depend on how the appliance is used and on the hardness of the water.	45	
Maximum temperature inside the treated textile (°C)	Rated capacity	39	Remaining moisture content (%)	53.9	
	Half	35			
	Quarter	24			
Spin speed (rpm)	Rated capacity	1400	Spin-drying efficiency class	B	
	Half	1400			
	Quarter	1400			
Programme duration (h:min)	Rated capacity	3:28	Type	Free-standing	
	Half	2:42			
	Quarter	2:42			
Airborne acoustical noise emissions in the spinning phase (dB(A) re 1 pW)	80		Airborne acoustical noise emission class (spinning phase)	C	

Off-mode (W)	0.50	Standby mode (W)	1.00
Delay start (W) (if applicable)	4.00	Networked standby (W) (if applicable)	-
Minimum duration of the guarantee offered by the supplier: 24 months			
This product has been designed to release silver ions during the washing cycle		No	
Additional information:			
Weblink to the supplier's website, where the information in point 9 of Annex II to Commission Regulation (EU) 2019/2023 is found: www.philco.cz			

* A (highest efficiency) to G (lowest efficiency)

Product Information Sheet

PHILCO 

COMMISSION DELEGATED REGULATION (EU) 2019/2016

Supplier's name or trademark: PHILCO

Supplier's address: FAST ČR, a.s., U Sanitasu 1621, 25101 Říčany, Czech Republic

Model identifier: PLDS 127 DG / PLDS 127 DGPL / PLDS 127 DGHU

General product parameters: Washing Machine

Parameter	Value		Parameter	Value	
Rated capacity (kg)	7.0		Dimensions in cm	Height	85
				Width	60
				Depth	40
EEI _w	80.0		Energy efficiency class*	D	
Washing efficiency index	1.031		Rinsing effectiveness (g/kg)	5.0	
Energy consumption in kWh per cycle, based on the eco 40-60 programme. Actual energy consumption will depend on how the appliance is used.	0.690		Water consumption in litre per cycle, based on the eco 40-60 programme. Actual water consumption will depend on how the appliance is used and on the hardness of the water.	45	
Maximum temperature inside the treated textile (°C)	Rated capacity	39	Remaining moisture content (%)	62.9	
	Half	35			
	Quarter	30			
Spin speed (rpm)	Rated capacity	1200	Spin-drying efficiency class	C	
	Half	1200			
	Quarter	1200			
Programme duration (h:min)	Rated capacity	3:28	Type	Free-standing	
	Half	2:42			
	Quarter	2:42			
Airborne acoustical noise emissions in the spinning phase (dB(A) re 1 pW)	80		Airborne acoustical noise emission class (spinning phase)	C	

Off-mode (W)	0.50	Standby mode (W)	1.00
Delay start (W) (if applicable)	4.00	Networked standby (W) (if applicable)	-
Minimum duration of the guarantee offered by the supplier: 24 months			
This product has been designed to release silver ions during the washing cycle		No	
Additional information:			
Weblink to the supplier's website, where the information in point 9 of Annex II to Commission Regulation (EU) 2019/2023 is found: www.philco.cz			

* A (highest efficiency) to G (lowest efficiency)

- 1) The actual energy consumption will depend on how the appliance is used.
- 2) The actual water consumption will depend on how the appliance is used and on the hardness of the water.
- 3) Delivery of the spare parts within 15 working days after having received the order.

Product Data Sheet concerning (EU) 2019/2014

The product data sheet for your appliance can be found online.

Go to <https://eprel.ec.europa.eu> and enter the model identifier for your appliance to download the data sheet. The model identifier for your appliance can be found in the technical specifications section.

TECHNICAL INFORMATION

Technical information can be found on the type plate on the inside of the appliance and on the energy label. The QR code, on the supplied energy label, contains a link to register the appliance in the EU Eprel database. Keep the energy label, the instructions for use, together with other documents supplied with the device.

TESTING INFORMATION

The delivered device is in accordance with EcoDesign and EN60456:2016,EN60456:2016/A11:2020, CLC/TS 50707:2020, CLC/TS 50677:2019, EN 50564:2011, EN 60704-1:2010+A11:2012, EN 60704-24:2012+A11:2020, EN 60704-3:2019. Air access requirements for proper operation of the device, the minimum distance from the wall and the dimensions of the device are part of this manual. If you have any further questions, please contact the manufacturer.

CUSTOMER CARE AND SERVICE

Always use original spare parts.

Model name and serial number can be found on the rating plate. Position of rating plate can be changed without notice.

The original spare parts for some specific components are available for a minimum of 7 or 10 years, based on the type of component, from the placing on the market of the last unit of the model.

When contacting our authorized service, have the model designation, serial number and defect description available.

To download documents, visit www.philco.cz.

To report a defect and obtain additional service information, visit <https://philco.cz/podpora-a-servis>.

Subject to change without notice.

INSTRUCTIONS AND INFORMATION REGARDING THE DISPOSAL OF USED PACKAGING MATERIALS

Dispose of packaging material at a public waste disposal site.

DISPOSAL OF USED ELECTRICAL AND ELECTRONIC APPLIANCES



The meaning of the symbol on the product, its accessory or packaging indicates that this product shall not be treated as household waste. Please, dispose of this product at your applicable collection point for the recycling of electrical & electronic equipment waste. Alternatively in some states of the European Union or other European states you may return your products to your local retailer when buying an equivalent new product. The correct disposal of this product will help save valuable natural resources and help in preventing the potential negative impact on the environment and human health, which could be caused as a result of improper liquidation of waste. Please ask your local authorities or the nearest waste collection centre for further details. The improper disposal of this type of waste may fall subject to national regulations for fines.

For business entities in the European Union

If you wish to dispose of an electrical or electronic device, request the necessary information from your seller or supplier.

Disposal in other countries outside the European Union

If you wish to dispose of this product, request the necessary information about the correct disposal method from local government departments or from your seller.



This product meets all the basic EU regulation requirements that relate to it.

Changes to the text, design and technical specifications may occur without prior notice and we reserve the right to make these changes.

Original of this user manual is in czech language.

Výrobce/Manufacturer:
Fast ČR, a.s.
U Sanítasu 1621
Říčany 251 01, CZECH REPUBLIC

Distributor:
FAST PLUS, a.s.
Na pántoch 18
831 06 Bratislava, SLOVAKIA

Distributor:
FAST POLAND Sp. z o. o.
Kwietniowa 36
05-090 Wypędy, POLAND

Distributor:
FAST HUNGARY Kft.
H-2310 Szigetszentmiklós
Kántor utca 10, HUNGARY

PHILCO[®] 

is a pending or registered trademark of Electrolux Home Products, Inc. and used under a license from Electrolux Home Products, Inc.