

# **FREEZER**

## **OWNER'S MANUAL**

**PHILCO**



*Famous for Quality the World Over*

**PTF 60 EW**

**Dear customer,  
Thank you for buying a PHILCO brand product. So that your appliance serves you well, please read all the instructions in this user's manual.**

# CONTENTS

<b>PART 1: SAFETY INFORMATION</b> .....	<b>3</b>
<b>PART 2: PROPER USE OF REFRIGERATOR</b> .....	<b>12</b>
PLACEMENT.....	12
LEVELLING FEET.....	13
DOOR RIGHT-LEFT CHANGE.....	14
START TO USE.....	16
ENERGY SAVING TIPS.....	17
TABLE CLIMATE CLASSES.....	17
SPECIAL FOR NEW EUROPEAN STANDARD.....	18
<b>PART 3: STRUCTURE AND FUNCTIONS</b> .....	<b>19</b>
KEY COMPONENTS.....	19
FREEZING CHAMBER.....	19
TEMPERATURE-CONTROL KNOB.....	20
<b>PART 4: MAINTENANCE AND CARE OF REFRIGERATOR</b> .....	<b>21</b>
CLEANING.....	21
DEFROST.....	22
STOP USING.....	22
<b>PART 5: TROUBLESHOOTING</b> .....	<b>23</b>
STORAGE INSTRUCTIONS.....	24
PLACEMENT OF FOOD IN THE APPLIANCE.....	25
<b>PART 6: PRODUCT INFORMATION SHEET</b> .....	<b>26</b>
TECHNICAL INFORMATION.....	28
TESTING INFORMATION.....	28
CUSTOMER CARE AND SERVICE.....	28
INSTRUCTIONS AND INFORMATION REGARDING THE DISPOSAL OF USED PACKAGING MATERIALS.....	29
DISPOSAL OF USED ELECTRICAL AND ELECTRONIC APPLIANCES.....	29



This appliance has been tested in accordance with the directives in force in the European Union.  
This appliance conforms to the relevant safety provisions for electrical appliances in force in the European Union.

## **Dear customer:**

Thank you for buying this refrigerator. To ensure that you get the best results from your new refrigerator, please take time to read through the simple instructions in this booklet.

Please ensure that the packing material is disposed of in accordance with the current environmental requirements.

When disposing of any refrigerator equipment please contact your local waste disposal department for advice on safe disposal.

This appliance must be only used for its intended purpose.

## **CAUTION:**

The appliance is not intended for use by young children or infirm persons without supervision.

Young children should be supervised to ensure that they do not play with the appliance.

## PART 1: SAFETY INFORMATION



FOR YOUR SAFETY AND CORRECT USAGE, BEFORE INSTALLING AND FIRST USING THE APPLIANCE, READ THIS USER MANUAL CAREFULLY, INCLUDING ITS HINTS AND WARNINGS. TO AVOID UNNECESSARY MISTAKES AND ACCIDENTS, IT IS IMPORTANT TO MAKE SURE THAT ALL PEOPLE USING THE APPLIANCE ARE THOROUGHLY FAMILIAR WITH ITS OPERATION AND SAFETY FEATURES. SAVE THESE INSTRUCTIONS AND BE SURE THAT THEY REMAIN WITH THE APPLIANCE IF IT IS MOVED OR SOLD, SO THAT ANYONE USING IT THROUGHOUT ITS LIFE, WILL BE PROPERLY INFORMED ON ITS USAGE AND SAFETY NOTICES. FOR THE SAFETY OF LIFE AND PROPERTY, KEEP THE PRECAUTIONS OF THESE USER'S INSTRUCTIONS AS THE MANUFACTURER IS NOT RESPONSIBLE FOR DAMAGES CAUSED BY OMISSION.

- THIS APPLIANCE CAN BE USED BY CHILDREN AGED FROM 8 YEARS AND ABOVE AND PERSONS WITH REDUCED PHYSICAL, SENSORY OR MENTAL CAPABILITIES OR LACK OF EXPERIENCE AND KNOWLEDGE IF THEY HAVE BEEN GIVEN SUPERVISION OR INSTRUCTION CONCERNING USE OF THE APPLIANCE IN A SAFE WAY AND UNDERSTAND THE HAZARDS INVOLVED.
- CHILDREN AGED FROM 3 TO 8 YEARS ARE ALLOWED TO LOAD AND UNLOAD REFRIGERATING APPLIANCES.
- CHILDREN SHALL NOT PLAY WITH THE APPLIANCE.
- CLEANING AND USER MAINTENANCE CANNOT BE PERFORMED BY CHILDREN WITHOUT SUPERVISION.

● IF THE SUPPLY CABLE GETS DAMAGED, HAVE IT REPLACED BY A SPECIALIZED SERVICE CENTER IN ORDER TO AVOID DANGEROUS SITUATIONS. IT IS PROHIBITED TO USE THE APPLIANCE WHEN THE SUPPLY CABLE IS DAMAGED.

● **CAUTION:** IF YOUR MODEL IS EQUIPPED WITH AN ICE MAKER WITHOUT WATER SUPPLY CONNECTION, FILL IT WITH DRINKING WATER ONLY.

● **WARNING:** KEEP VENTILATION OPENINGS, IN THE APPLIANCE ENCLOSURE OR IN THE BUILT-IN STRUCTURE, CLEAR OF OBSTRUCTION.

● **WARNING:** DO NOT USE MECHANICAL DEVICES OR OTHER MEANS TO ACCELERATE THE DEFROSTING PROCESS, OTHER THAN THOSE RECOMMENDED BY THE MANUFACTURER.

● **WARNING:** DO NOT DAMAGE THE REFRIGERANT CIRCUIT.

● **WARNING:** DO NOT USE ELECTRICAL APPLIANCES INSIDE THE FOOD STORAGE COMPARTMENTS OF THE APPLIANCE, UNLESS THEY ARE OF THE TYPE RECOMMENDED BY THE MANUFACTURER.

● **WARNING:** DO NOT STORE EXPLOSIVE SUBSTANCES SUCH AS AEROSOL CANS WITH A FLAMMABLE PROPELLANT IN THIS APPLIANCE.

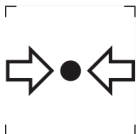

ISO 7000-1701 MARK (2004-01)  
LABELS MEDIA UNDER PRESSURE.

THIS APPLIANCE IS INTENDED TO BE USED IN HOUSEHOLDS AND SIMILAR PREMISES, SUCH AS:

– KITCHENETTES IN SHOPS, OFFICES AND OTHER WORKPLACES; APPLIANCES USED BY GUESTS IN HOTELS, MOTELS, AND OTHER ACCOMMODATION FACILITIES; APPLIANCES USED IN BED-AND-BREAKFAST FACILITIES; APPLIANCES USED IN CATERING AND OTHER SIMILAR NON-VENDING ENVIRONMENTS.

ONLY SOME REFRIGERATOR MODELS ARE EQUIPPED WITH ICE MAKER. INTEGRATED ICE MAKERS MUST BE INSTALLED BY THE MANUFACTURER OR ITS SERVICING ORGANIZATION ONLY.

● THE FOLLOWING GOES FOR SELECTED MODELS EQUIPPED WITH AN ICE MAKER WITH WATER CONNECTION:

**CAUTION:** CAN ONLY BE CONNECTED TO DRINKING WATER SUPPLY.

● **CAUTION:** THE APPLIANCE MUST BE FASTENED IN ACCORDANCE WITH THE MANUAL TO PREVENT DANGER CAUSED BY ITS INSTABILITY.

● **CAUTION:** THE COOLING SYSTEM CONTAINS REFRIGERANT UNDER HIGH PRESSURE. DO NOT MANIPULATE WITH THE SYSTEM. THE SYSTEM MAY BE REPAIRED BY AUTHORIZED PERSONS ONLY.



**WARNING :**  
RISK OF FIRE / FLAMMABLE MATERIALS

CONTAINS COOLING GAS ISOBUTANE

# R600a

## REFRIGERANT

THE REFRIGERANT ISOBUTENE (R600a) IS CONTAINED WITHIN THE REFRIGERANT CIRCUIT OF THE APPLIANCE, A NATURAL GAS WITH A HIGH LEVEL OF ENVIRONMENTAL COMPATIBILITY, WHICH IS NEVERTHELESS FLAMMABLE. DURING TRANSPORTATION AND INSTALLATION OF THE APPLIANCE, ENSURE THAT NONE OF THE COMPONENTS OF THE REFRIGERANT CIRCUIT BECOMES DAMAGED. THE REFRIGERANT (R600a) IS FLAMMABLE.

● **WARNING** — REFRIGERATORS CONTAIN REFRIGERANT AND GASES IN THE INSULATION. REFRIGERANT AND GASES MUST BE DISPOSED OF PROFESSIONALLY AS THEY MAY CAUSE EYE INJURIES OR IGNITION. ENSURE THAT TUBING OF THE REFRIGERANT CIRCUIT IS NOT DAMAGE PRIOR TO PROPER DISPOSAL.



THE SYMBOL  IS A WARNING AND INDICATES THE REFRIGERANT AND INSULATION BLOWING GAS ARE FLAMMABLE.



## **WARNING : RISK OF FIRE / FLAMMABLE MATERIALS**

IF THE REFRIGERANT CIRCUIT SHOULD BE DAMAGED:

- AVOID OPENING FLAMES AND SOURCES OF IGNITION.
- THOROUGHLY VENTILATE THE ROOM IN WHICH THE APPLIANCE IS SITUATED.

IT IS DANGEROUS TO ALTER THE SPECIFICATIONS OR MODIFY THIS PRODUCT IN ANY WAY.

ANY DAMAGE TO THE CORD MAY CAUSE A SHORT CIRCUIT, FIRE, AND/OR ELECTRIC SHOCK.

● **CAUTION:** THE COOLING SYSTEM CONTAINS REFRIGERANT UNDER HIGH PRESSURE. DO NOT MANIPULATE WITH THE SYSTEM.

THE SYSTEM MAY BE REPAIRED BY AUTHORIZED PERSONS ONLY.

● **CAUTION:** WHEN PLACING THE APPLIANCE IT MUST BE ENSURED THAT THE SUPPLY CORD DOES NOT GET CAUGHT OR DAMAGED.

● **CAUTION:** DO NOT PLACE PORTABLE MULTIPLE SOCKET-OUTLETS OR PORTABLE EXTENSION CABLES TO THE REAR SIDE OF THE APPLIANCE.



### **ELECTRICAL SAFETY**

1. THE POWER CORD MUST NOT BE LENGTHENED.
2. MAKE SURE THAT THE POWER PLUG IS NOT CRUSHED OR DAMAGED.  
A CRUSHED OR DAMAGED POWER PLUG MAY OVERHEAT AND CAUSE A FIRE.
3. MAKE SURE THAT YOU CAN ACCESS THE MAIN PLUG OF THE APPLIANCE.
4. DO NOT PULL THE MAIN CABLE.

5. IF THE POWER PLUG SOCKET IS LOOSE, DO NOT INSERT THE POWER PLUG. THERE IS A RISK OF ELECTRIC SHOCK OR FIRE.
6. YOU MUST NOT OPERATE THE APPLIANCE WITHOUT THE INTERIOR LIGHTING LAMP COVER.
7. THE FRIDGE IS ONLY APPLIED WITH POWER SUPPLY OF SINGLE PHASE ALTERNATING CURRENT OF 220-240~ V/50HZ. IF FLUCTUATION OF VOLTAGE IN THE DISTRICT OF USER IS SO LARGE THAT THE VOLTAGE EXCEEDS THE ABOVE SCOPE, FOR SAFETY SAKE, BE SURE TO APPLY A.C. AUTOMATIC VOLTAGE REGULATOR OF MORE THAN 350W TO THE FRIDGE.

THE FRIDGE MUST EMPLOY A SPECIAL POWER SOCKET INSTEAD OF COMMON ONE WITH OTHER ELECTRIC APPLIANCES. ITS PLUG MUST MATCH THE SOCKET WITH GROUND WIRE.

## **DAILY USE**

- DO NOT STORE FLAMMABLE GAS OR LIQUIDS IN THE APPLIANCE, THERE IS A RISK OF AN EXPLOSION.
- DO NOT OPERATE ANY ELECTRICAL APPLIANCES IN THE APPLIANCE (E.G. ELECTRIC ICE CREAM MAKERS, MIXERS ETC.).
- WHEN UNPLUGGING ALWAYS PULL THE PLUG FROM THE MAINS SOCKET, DO NOT PULL ON THE CABLE.
- DO NOT PLACE HOT ITEMS NEAR THE PLASTIC COMPONENTS OF THIS APPLIANCE.
- DO NOT PLACE FOOD PRODUCTS DIRECTLY AGAINST THE AIR OUTLET ON THE REAR WALL.
- STORE PRE-PACKED FROZEN FOOD IN ACCORDANCE WITH THE FROZEN FOOD MANUFACTURE'S INSTRUCTIONS.
- THE APPLIANCES MANUFACTURES STORAGE RECOMMENDATIONS SHOULD BE STRICTLY ADHERED TO. REFER TO RELEVANT INSTRUCTIONS FOR STORAGE.

- DO NOT PLACE CARBONATED OR FIZZY DRINKS IN THE FREEZER COMPARTMENT AS IT CREATES PRESSURE ON THE CONTAINER,WHICH MAY CAUSE IT TO EXPLODE,RESULTING IN DAMAGE TO THE APPLIANCE.
- FROZEN FOOD CAN CAUSE FROST BURNS IF CONSUMED STRAIGHT FROM THE FREEZER COMPARTMENT.
- DO NOT PLACE THE APPLIANCE IN DIRECT SUNLIGHT.
- KEEP BURNING CANDLES,LAMPS AND OTHER ITEMS WITH NAKED FLAMES AWAY FROM THE APPLIANCE SO THAT DO NOT SET THE APPLIANCE ON FIRE.
- THE APPLIANCE IS INTENDED FOR KEEPING FOOD STUFF AND/ OR BEVERAGES IN NORMAL HOUSEHOLD AS EXPLAINED IN THIS INSTRUCTION BOOKLET. YOU SHOULD TAKE CARE WHEN MOVE IT AS THE APPLIANCE IS HEAVY.
- DO NOT REMOVE OR TOUCH ITEMS FROM THE FREEZER COMPARTMENT IF YOUR HANDS ARE DAMP/WET, AS THIS COULD CAUSE SKIN ABRASIONS OR FROST/FREEZER BURNS.
- NEVER USE THE BASE,DRAWERS,DOORS ETC. TO STAND ON OR AS SUPPORTS.
- FROZEN FOOD MUST NOT BE REFROZEN ONCE IT HAS BEEN THAWED OUT.
- DO NOT CONSUME ICE POPSICLES OR ICE CUBES STRAIGHT FROM THE FREEZER AS THIS CAN CAUSE FREEZER BURN TO THE MOUTH AND LIPS.
- TO AVOID ITEMS FALLING AND CAUSING INJURY OR DAMAGE TO THE APPLIANCE,DO NOT OVERLOAD THE DOOR RACKS OR PUT TOO MUCH FOOD IN THE CRISPER DRAWERS.

## **INSTALLATION IMPORTANT!**

- FOR ELECTRICAL CONNECTION CAREFULLY, FOLLOW THE INSTRUCTIONS GIVEN IN THIS MANUAL. UNPACK THE APPLIANCE AND CHECK IF THERE ARE DAMAGES ON IT.
- DO NOT CONNECT THE APPLIANCE IF IT IS DAMAGED. REPORT POSSIBLE DAMAGES IMMEDIATELY TO THE PLACE YOU BOUGHT IT. IN THIS CASE RETAIN PACKING.
- IT IS ADVISABLE TO WAIT AT LEAST FOUR HOURS BEFORE CONNECTING THE APPLIANCE TO ALLOW THE OIL TO FLOW BACK IN THE COMPRESSOR.
- ADEQUATE AIR CIRCULATION SHOULD BE AROUND THE APPLIANCE, LACKING THIS LEADS TO OVERHEATING. TO ACHIEVE SUFFICIENT VENTILATION, FOLLOW THE INSTRUCTIONS RELEVANT TO INSTALLATION.
- WHEREVER POSSIBLE THE BACK OF THE PRODUCT SHOULD NOT BE TOO CLOSE TO A WALL TO AVOID TOUCHING OR CATCHING WARM PARTS (COMPRESSOR, CONDENSER) TO PREVENT THE RISK OF A FIRE, FOLLOW THE INSTRUCTIONS RELEVANT TO INSTALLATION.
- THE APPLIANCE MUST NOT BE LOCATE CLOSE TO RADIATORS OR COOKERS.
- MAKE SURE THAT THE MAINS PLUG IS ACCESSIBLE AFTER THE INSTALLATION OF THE APPLIANCE.
- PLACE ALL PACKAGING MATERIALS OUT OF THE REACH OF CHILDREN, THERE IS A RISK OF SUFFOCATION.

- THE INTERIOR OF YOUR REFRIGERATOR / FREEZER MAY SMELL BEFORE FIRST USE. THIS IS NORMAL. THE ODOR DISAPPEARS AS SOON AS THE APPLIANCE STARTS TO COOL / FREEZE.
- BEFORE CONNECTING THE REFRIGERATOR I FREEZER, MAKE SURE THAT THE MAINS VOLTAGE CORRESPONDS TO THE REQUIREMENTS FOR CONNECTING THE REFRIGERATOR / FREEZER. IF IN DOUBT, CONSULT A QUALIFIED ELECTRICIAN.
- THE APPLIANCE MUST BE CONNECTED TO A SOCKET WITH THE APPROPRIATE VOLTAGE AND A CORRECTLY INSTALLED FUSE SOCKET.
- THE REFRIGERATOR I FREEZER MUST NOT BE PLACED OUTDOORS OR EXPOSED TO RAIN.
- THE REFRIGERATOR I FREEZER MUST BE LOCATED AT LEAST 50CM FROM HEATERS, ELECTRIC OVENS, GAS OVENS, ETC.
- IF THE REFRIGERATOR WITH FREEZER IS LOCATED NEXT TO THE FREEZER, THERE MUST BE A MIN. 2CM SPACING.
- DO NOT PLACE HEAVY OBJECTS ON THE REFRIGERATOR / FREEZER, DO NOT COVER IT.
- ABOVE THE FRIDGE / FREEZER THERE MUST BE A MIN. 150MM FREE SPACE.
- INSTALL TWO PLASTIC GUIDES ON THE REFRIGERATOR / FREEZER CONDENSER THAT PREVENT THE WALL AND CONDENSER FROM TOUCHING.
- THIS APPLIANCE IS MADE FOR DOMESTIC USE AND IS ONLY SUITABLE FOR COOLING / FREEZING FOOD. NOT SUITABLE FOR COMMERCIAL USE AND / OR STORAGE OF SUBSTANCES OTHER THAN FOOD. THE MANUFACTURER IS NOT LIABLE FOR ANY LOSSES CAUSED BY IMPROPER USE OF THE APPLIANCE.

## PART 2: PROPER USE OF REFRIGERATOR

### Placement

- Before use, remove all packing materials, including bottom cushions, foam pads and tapes inside of the refrigerator; tear off the protective film on the doors and the refrigerator body.

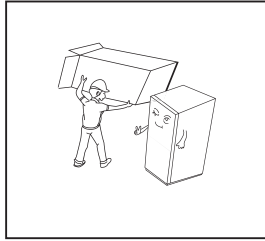

- Keep away from heat and avoid direct sunlight. Do not place the freezer in moist or watery places to prevent rust or reduction of insulating effect.
- Do not spray or wash the refrigerator; do not put the refrigerator in moist places easy to be splashed with water so as not to affect the electrical insulation properties of the refrigerator.

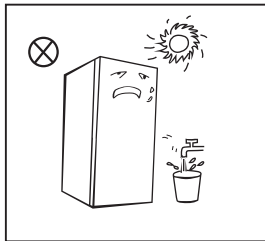

- The refrigerator is placed in a well-ventilated indoor place; the ground shall be flat, and sturdy (rotate left or right to adjust the wheel for leveling if unstable).

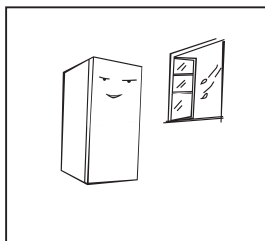

- The top space of the refrigerator shall be greater than 30cm, and the refrigerator should be placed against a wall with a free distance more than 10cm to facilitate heat dissipation.

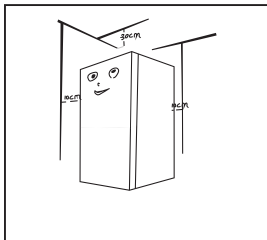

Precautions before installation:

Information in the Instruction Manual is only for reference. The physical product may differ. Before installation and adjusting of accessories, it shall be ensured that the refrigerator is disconnected from power. Precautions shall be taken to prevent fall of the handle from causing any personal injury.

## Levelling feet

Schematic diagram of the levelling feet

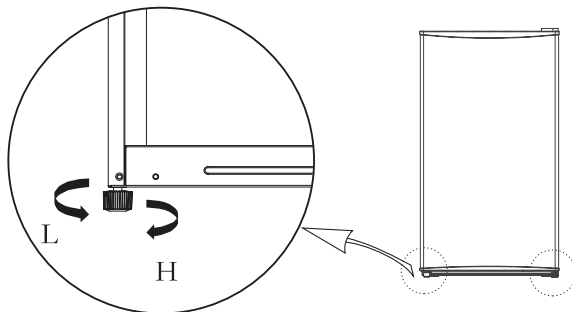





(The picture above is only for reference. The actual configuration will depend on the physical product or statement by the distributor)

Adjusting procedures:

- Turn the feet clockwise to raise the refrigerator;
- Turn the feet counterclockwise to lower the refrigerator;
- Adjust the right and left feet based on the procedures above to a horizontal level.

## Door Right-Left Change

List of tools to be provided by the user			
	Cross screwdriver		Putty knife thin-blade screwdriver
	5/16" socket spanner		Masking tape

Parts to be used for door reverse			
Number	Name	Number	Note
1	Upper hinge	1	Pre-installed on the refrigerator, still used when door is reversed
2	Hinge cover	1	Pre-installed on the refrigerator, still used when door is reversed
3	Tapping locking screw	5	Pre-installed on the refrigerator, still used when door is reversed
4	Hole cap	1	Pre-installed on door end caps, still used when door is reversed
5	Pin	2	Pre-installed on the refrigerator, still used when door is reversed
6	Lower hinge assembly	1	Pre-installed on the refrigerator, still used when door is reversed
7	Levelling foot	1	Pre-installed on the refrigerator, still used when door is reversed
8	Tapping screw	1	Pre-installed on door end caps, still used when door is reversed



- 1) Power off the refrigerator, and remove all objects from the door trays.
- 2) Dismantle the hinge cover, screws and upper hinge, and remove the hole cap and pins from the other side.

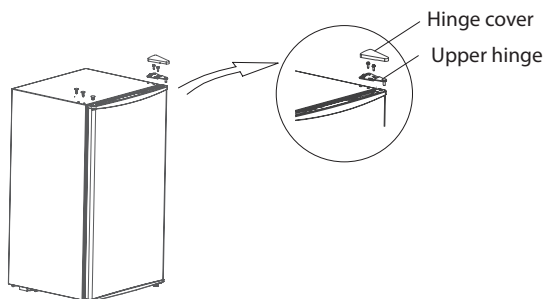

- 3) Remove the door first, then remove the lower hinge assembly and levelling foot, interchange the positions of the lower hinge assembly and levelling foot and install them.

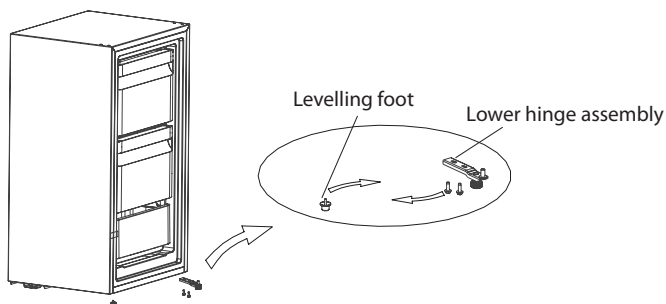

- 4) Dismantle the hole cap under the door, then assemble the hole cap on the other side.

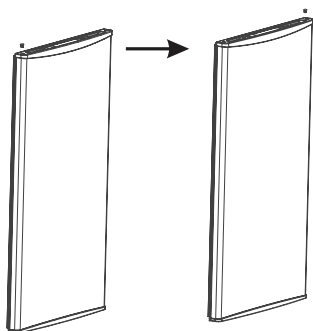

- 5) Install the door on the lower hinge assembly, and then install the upper hinge, hinge cover, pins and hole cap in sequence.

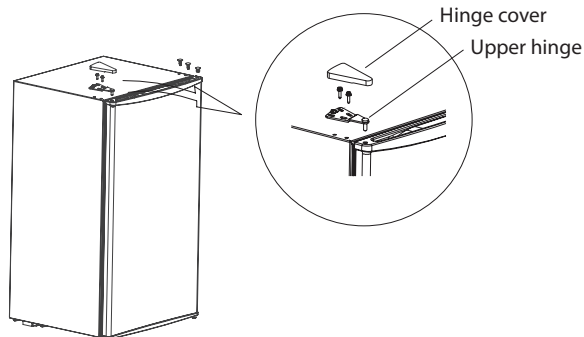

(The picture above is only for reference. The actual configuration will depend on the physical product or statement by the distributor)

## Start to use

- Before initial start, keep the refrigerator still for half an hour before connecting it to power supply.
- Before putting any fresh or frozen foods, the refrigerator shall have run for 2-3 hours, or for above 4 hours in summer when the ambient temperature is high.

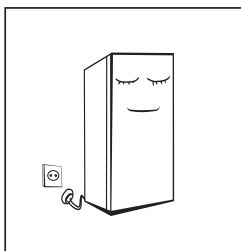

- Spare enough space for convenient opening of the doors and drawers or statement by the distributor.

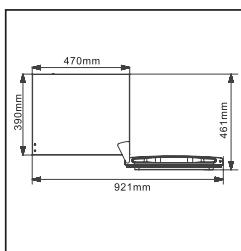

## Energy saving tips

- The appliance should be located in the coolest area of the room, away from heat producing appliances or heating ducts, and out of the direct sunlight.
- Let hot foods cool to room temperature before placing in the appliance. Overloading the appliance forces the compressor to run longer. Foods that freeze too slowly may lose quality, or spoil.
- Be sure to wrap foods properly, and wipe containers dry before placing them in the appliance. This cuts down on frost build-up inside the appliance.
- Appliance storage bin should not be lined with aluminum foil, wax paper, or paper toweling. Liners interfere with cold air circulation, making the appliance less efficient.
- Organize and label food to reduce door openings and extended searches. Remove as many items as needed at one time, and close the door as soon as possible.

## Table Climate classes

Class	Symbol	Ambient temperature range °C
Extended temperate	SN	+ 10 to + 32
Temperate	N	+ 16 to + 32
Subtropical	ST	+ 16 to + 38
Tropical	T	+ 16 to+ 43

### Extended temperate:

this refrigerating appliance is intended to be used at ambient temperatures ranging from 10°C to 32°C;

### Temperate:

this refrigerating appliance is intended to be used at ambient temperatures ranging from 16°C to 32°C;

### Subtropical:

this refrigerating appliance is intended to be used at ambient temperatures ranging from 16°C to 38°C;

### Tropical:

this refrigerating appliance is intended to be used at ambient temperatures ranging from 16°C to 43°C;

If the wine cooler operates outside the climate class (ambient temperature range) for which it is rated then it may not be able to maintain satisfactory eternal temperatures.

## Special for new European standard

- The ordered parts in the following table can be acquired from channel:

<b>Ordered Part</b>	<b>Provided by</b>	<b>Minimum Time Required for Provision</b>
thermostats	Professional maintenance personnel.	At least 7 years after the last model is launched on the market.
temperature sensors	Professional maintenance personnel.	At least 7 years after the last model is launched on the market.
printed circuit boards	Professional maintenance personnel.	At least 7 years after the last model is launched on the market.
door handles	Professional repairers and final users.	At least 7 years after the last model is launched on the market.
door hinges	Professional repairers and final users.	At least 7 years after the last model is launched on the market.
trays	Professional repairers and final users.	At least 7 years after the last model is launched on the market.
baskets	Professional repairers and final users.	At least 7 years after the last model is launched on the market.
door gaskets	Professional repairers and final users.	At least 10 years after the last model is launched on the market.

- The shortest period for providing after-sales spare parts is 15 working days.
- The model information and model identification in the product database can be obtained by scanning the web link on the QR code (if any) on the product energy efficiency label.

### Dear customer

1. If you want to return or replace the product, please contact the store where you buy.  
(Remember to bring the purchase invoice)
2. If your product breaks down which needs to repair, please contact after-sales service provider.  
Telephone:  
Email address:

## PART 3: STRUCTURE AND FUNCTIONS

### Key components

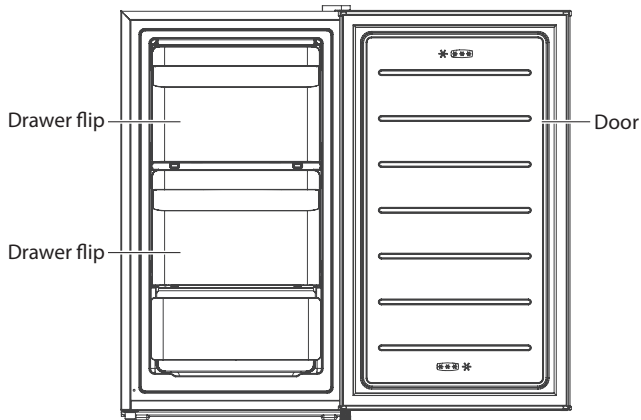

(The picture above is only for reference. The actual configuration will depend on the physical product or statement by the distributor)

### Freezing chamber

- The low temperature freezing chamber may keep food fresh for a long time and it is mainly used to store frozen foods and making ice.  
Putting food in the bottom drawer is the most energy efficient.
- The freezing chamber is suitable for storage of meat, fish, rice balls and other foods not to be consumed in short term.
- Large pieces of meat should be divided into small pieces as much as possible and then put in, which is convenient for quick freezing and taking.  
**Note:** Storage of too much food during operation after the initial connection to power may adversely affect the freezing effect of the refrigerator. Foods stored shall not block the air outlet; or otherwise the freezing effect will also be adversely affected.

## Temperature-control knob

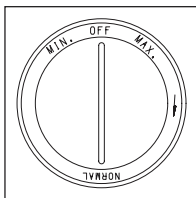

- The markings on control knob indicate the "MIN, NORMAL, MAX and OFF" for the different temperature level.  
"MIN." is the warmest setting;  
"MAX." is the coldest setting;  
For normal use, please set the control knob to "NORMAL" position.  
Recommended gear: "NORMAL"

## PART 4: MAINTENANCE AND CARE OF REFRIGERATOR

### Cleaning

- Dusts behind the refrigerator and on the ground shall be timely cleaned to improve the cooling effect and energy saving.
- Check the door gasket regularly to make sure there are no debris. Clean the door gasket with a soft cloth dampened with soapy water or diluted detergent.
- The interior of the refrigerator should be cleaned regularly to avoid odor.
- Please turn off the power before cleaning interior, remove all foods, drinks .shelves, drawers, etc.
- Use a soft cloth or sponge to clean the inside of the refrigerator, with two tablespoons of baking soda and a quart of warm water. Then rinse with water and wipe clean. After cleaning, open the door and let it dry naturally before turning on the power.
- For areas that are difficult to clean in the refrigerator (such as narrow sandwiches, gaps or corners), it is recommended to wipe them regularly with a soft rag, softbrush, etc. and when necessary,combined with some auxiliary tools (such as thin sticks) to ensure no contaminants or bacterials accumulation in these areas.
- Do not use soap, detergent, scrub powder, spray cleaner, etc., as these may cause odors in the interior of the refrigerator or contaminated food.
- Clean the bottle frame, shelves and drawers with a soft cloth dampened with soapy water or diluted detergent. Dry with a soft cloth or dry naturally.
- Wipe the outer surface of the refrigerator with a soft cloth dampened with soapy water, detergent, etc., and then wipe dry.
- Do not use hard brushes, clean steel balls, wire brushes, abrasives(such as toothpastes), organic solvents (such as alcohol, acetone, banana oil, etc.), boiling water, acid or alkaline items, which may damage the cooler surface and interior. Boiling water and organic solvents such as benzene may deform or damage plastic parts.
- Do not rinse directly with water or other liquids during cleaning to avoid short circuits or affect electrical insulation after immersion.



Please unplug the refrigerator for defrost and cleaning.

## Defrost

- Power off the refrigerator.
- Remove the food from the refrigerator and place it properly to prevent food from melting.
- Clear the drain pipe (to use soft materials to prevent damage to the liner). Prepare the water containers for defrosting.  
(Pay attention to clean the compressor compartment water draining tray. Avoiding overflow to the ground).
- You can use the natural temperature for the natural defrost, you can also use the ice shovel to eliminate the frost (to use plastic or wooden ice shovel, for avoiding damage to the liner or pipe)
- You can also use the appropriate amount of hot water to speed up the defrost, with a dry towel to dry the water after defrosting.
- After defrosting, put back the foods in cabinet, and power on the refrigerator.

## Stop using

- Power failure: In case of power failure, even if it is in summer, foods inside the appliance can be kept for several hours; during the power failure, the times of door opening shall be reduced, and no more fresh food shall be put into the appliance.
- Long-time nonuse: The appliance shall be unplugged and then cleaned; then the doors are left open to prevent odor.
- Moving: Before the refrigerator is moved, take all objects inside out, fix the glass partitions, vegetable holder, freezing chamber drawers and etc. with tape, and tighten the leveling feet; close the doors and seal them with tape. During moving, the appliance shall not be laid upside down or horizontally, or be vibrated; the inclination during movement shall be no more than 45°. Do not hold the door and hinge when moving this unit.

The appliance shall run continuously once it is started. Generally, the operation of the appliance shall not be interrupted; or otherwise the service life may be impaired.



## PART 5: TROUBLESHOOTING

You may try to solve the following simple problems by yourself.  
If them cannot be solved, please contact the after-sales department.

Problem	Possible Cause & Solution
Not work.	Check whether the appliance is connected to power or whether the plug is in well contact. Check whether the voltage is too low. Check whether there is a power failure or partial circuits have tripped.
Odor.	Odorous foods shall be tightly wrapped. Check whether there is any rotten food. Clean the inside of the refrigerator.
Long-time operation of the compressor.	Long operation of the refrigerator is normal in summer when the ambient temperature is high. It is not suggestible having too much food in the appliance at the same time. Food shall get cool before being put into the appliance. The doors are opened too frequently.
Doors cannot be properly closed.	The door is stuck by food package. Too much food is placed. The refrigerator is tilted.
Loud noise.	Check whether the floor is level and whether the refrigerator is placed stably. Check whether accessories are placed at proper locations.
Gasket gap.	Remove foreign matters on the door seal. Heat the door seal and then cool it for restoration (or blow it with an electrical drier or use a hot towel for heating).
Water pan overflows.	There is too much food in the chamber or food stored contains too much water,resulting in heavy defrosting. The doors are not closed properly, resulting in frosting due to entry of air and increased water due to defrosting.
Over heat on sidewall.	Heat dissipation of the built-in condenser via the housing, which is normal. When housing becomes hot due to high ambient temperature, storage of too much food or shutdown of the compressor is shut down, provide sound ventilation to facilitate heat dissipation.
Surface condensation.	Condensation on the exterior surface and door seals of the refrigerator is normal when the ambient humidity is too high. Just wipe the condensate with a clean towel.
Abnormal noise.	Buzz: The compressor may produce buzzes during operation, and the buzzes are loud particularly upon start or stop. This is normal. Creak: Refrigerant flowing inside of the appliance may produce creak, which is normal.

## Storage instructions

To avoid contamination of food, please respect the following instructions

- Opening the door for long periods can cause a significant increase of the temperature in the compartments of the appliance.
- Clean regularly surfaces that can come in contact with food and accessible drainage systems.
- Store raw meat and fish in suitable containers in the refrigerator, so that it is not in contact with or drip onto other food.
- Two-star frozen-food compartments are suitable for storing pre-frozen food, storing or making icecream and making ice cubes.
- One-, two- and three-star compartments are not suitable for the freezing of fresh food.

Order	Compartments TYPE	Target storage temp.[°C]	Appropriate food
1	Fridge	+2~+8	Eggs, cooked food, packaged food, fruits and vegetables, dairy products, cakes, drinks and other foods which are not suitable for freezing.
2	(***)*-Freezer	≤-18	Seafood (fish,shrimp,shellfish),freshwater aquatic products and meat products (recommended for 3 months , he longer the storage time,the worse the taste and nutrition),suitable for frozen fresh food.
3	***-Freezer	≤-18	Seafood (fish, shrimp, shellfish),freshwater aquatic products and meat products (recommended for 3 months, the longer the storage time,the worse the taste and nutrition), are not suitable for frozen fresh food
4	**-Freezer	≤-12	Seafood (fish, shrimp, shellfish), freshwater aquatic products and meat products (recommended for 2 months,the longer the storage time,the worse the taste and nutrition), are not suitable for frozen fresh food.
5	*-Freezer	≤-6	Seafood (fish, shrimp, shellfish), freshwater aquatic products and meat products (recommended for 1 month,the longer the storage time,the worse the taste and nutrition), are not suitable for frozen fresh food.
6	0-star	-6~0	Fresh pork, beef, fish, chicken, some packaged processed foods, etc. (Recommended to eat within the same day, preferably no later than 3 days). Partially encapsulated processed foods (non-freezable foods.)

7	Chill	-2~+3	Fresh/frozen pork, beef, chicken, freshwater aquatic products, etc. (7 days below 0 °C and above 0 °C is recommended for consumption within that day, preferably no more than 2 days). Seafood (less than 0 for 15 days, it is not recommended to store above 0 °C).
8	Fresh Food	0~+4	Fresh pork,beef,fish,chicken,cooked food,etc. (Recommended to eat within the same day,preferably no more than 3 days.)
9	Wine	+5~+20	Red wine,white wine,sparkling wine etc.

**Note:** Please store different foods according to the compartments or target storage temperature of your purchased products.

- If the refrigerating appliance is left empty for long periods,switch off,defrost, clean,dry, and leave the door open to prevent mould developing within the appliance.

## Placement of food in the appliance

- Potatoes, onions and garlic should not be stored in the refrigerator / freezer.
- Under normal circumstances, the temperature setting in the refrigerator is sufficient to + 4 °C.
- The temperature of the refrigerator should be between 0 °C and 80 C. Fresh foods stored below 0 °C freeze, rot. The bacterial load increases when stored above 8 °C and food spoils.
- Do not put warm or hot food in the fridge / freezer, wait for it to cool to room temperature. Hot food raise the temperature inside the refrigerator / freezer and can cause unnecessary spoilage and possible food poisoning.
- Meat, fish, etc. should be stored in a designated refrigerated compartment - if available.
- Fruits and vegetables should be stored in a designated refrigerated compartment - if available.
- To prevent contamination of meat products with bacteria, do not store fruits and vegetables in a common compartment. The same is true in reverse - contamination of fruits and vegetables with bacteria from meat products.

# PART 6: PRODUCT INFORMATION SHEET

## Product Information Sheet

PHILCO 

COMMISSION DELEGATED REGULATION (EU) 2019/2016

**Supplier's name or trademark:** PHILCO

**Supplier's address:** FAST ČR, a.s., U Sanitasu 1621, Říčany 251 01, Czech Republic

**Model identifier:** PTF 60 EW

**Type of refrigerating appliance:** Freezer

Low-noise appliance:	No	Design type:	freestanding
----------------------	----	--------------	--------------

Wine storage appliance:	No	Other refrigerating appliance:	Yes
-------------------------	----	--------------------------------	-----

### General product parameters:

Parameter		Value	Parameter	Value
Overall dimensions (millimetre)	Height	845	Total volume (dm <sup>3</sup> or l)	60
	Width	475		
	Depth	445		
Energy efficiency Index (EEL)		100	Energy efficiency class*	E
Airborne acoustical noise emissions (dB(A) re 1 pW)		41	Airborne acoustical noise emission class	C
Annual energy consumption (kWh/a)		156	Climate class:	temperate, subtropical
Minimum ambient temperature (°C), for which the refrigerating appliance is suitable		16	Maximum ambient temperature (°C), for which the refrigerating appliance is suitable	38
Winter setting		No		

### Compartment Parameters:

Compartment type	Compartment parameters and values			
	Compartment volume (dm <sup>3</sup> or l)	Recommended temperature setting for optimised food storage (°C) These settings shall not contradict the storage conditions set out in Annex IV, Table 3	Freezing capacity (kg/24h)	Defrosting type (auto-defrost=A, manual defrost=M)
Pantry	No	-	-	-

Wine storage	No	-	-	-	-
Cellar	No	-	-	-	-
Fresh food	No	-	-	-	-
Chill	No	-	-	-	-
0-star or ice-making	No	-	-	-	-
1-star	No	-	-	-	-
2-star	No	-	-	-	-
3-star	No	-	-	-	-
4-star	Yes	60.0	-18	6.0	M
2-star section	No	-	-	-	-
Variable temperature compartment	-	-	-	-	-
<b>For 4-star compartments</b>					
Fast freeze facility			No		
<b>Light source parameters:</b>					
Type of light source			-		
Energy efficiency class			-		
<b>Minimum duration of the guarantee offered by the manufacturer:</b> 24 months					
<b>Additional information:</b>					
<b>Weblink to the manufacturer's website, where the information in point 4(a) Annex of Commission Regulation (EU) 2019/2019 is found:</b> <a href="http://www.philco.cz">www.philco.cz</a>					

\* A (highest efficiency) to G (lowest efficiency)

## TECHNICAL INFORMATION

Technical information can be found on the type plate on the inside of the appliance and on the energy label. The QR code, on the supplied energy label, contains a link to register the appliance in the EU Eprel database. Keep the energy label, the instructions for use, together with other documents supplied with the device.

## TESTING INFORMATION

The delivered device is in accordance with EcoDesign and EN62552. Air access requirements for proper operation of the device, the minimum distance from the wall and the dimensions of the device are part of this manual. If you have any further questions, please contact the manufacturer.

## CUSTOMER CARE AND SERVICE

Always use original spare parts.

Model name and serial number can be found on the rating plate. Position of rating plate can be changed without notice.

The original spare parts for some specific components are available for a minimum of 7 or 10 years, based on the type of component, from the placing on the market of the last unit of the model.

When contacting our authorized service, have the model designation, serial number and defect description available.

To download documents, visit [www.philco.cz](http://www.philco.cz).

To report a defect and obtain additional service information, visit <https://philco.cz/podpora-a-servis>.

Subject to change without notice.

## INSTRUCTIONS AND INFORMATION REGARDING THE DISPOSAL OF USED PACKAGING MATERIALS

Dispose of packaging material at a public waste disposal site.

## DISPOSAL OF USED ELECTRICAL AND ELECTRONIC APPLIANCES



The meaning of the symbol on the product, its accessory or packaging indicates that this product shall not be treated as household waste. Please, dispose of this product at your applicable collection point for the recycling of electrical & electronic equipment waste. Alternatively in some states of the European Union or other European states you may return your products to your local retailer when buying an equivalent new product. The correct disposal of this product will help save valuable natural resources and help in preventing the potential negative impact on the environment and human health, which could be caused as a result of improper liquidation of waste. Please ask your local authorities or the nearest waste collection centre for further details. The improper disposal of this type of waste may fall subject to national regulations for fines.

### For business entities in the European Union

If you wish to dispose of an electrical or electronic device, request the necessary information from your seller or supplier.

### Disposal in other countries outside the European Union

If you wish to dispose of this product, request the necessary information about the correct disposal method from local government departments or from your seller.



This product meets all the basic EU regulation requirements that relate to it.

Changes to the text, design and technical specifications may occur without prior notice and we reserve the right to make these changes.

Original of this user manual is Czech.



**WARNING!** DURING USING, SERVICE AND DISPOSAL THE APPLIANCE, PLEASE PAY ATTENTION TO SYMBOL SIMILAR AS LEFT SIDE, WHICH IS LOCATED ON REAR OF APPLIANCE (REAR PANEL OR COMPRESSOR) AND WITH YELLOW OR ORANGE COLOR.



IT'S RISK OF RE WARNING SYMBOL. THERE ARE FLAMMABLE MATERIALS IN REFRIGERANT PIPES AND COMPRESSOR. PLEASE BE FAR AWAY RE SOURCE DURING USING, SERVICE AND DISPOSAL.

Výrobce/Manufacturer:  
Fast ČR, a.s.  
U Sanítasu 1621  
Říčany 251 01, CZECH REPUBLIC

Distributor:  
FAST PLUS, a.s.  
Na pántoch 18  
831 06 Bratislava, SLOVAKIA

Distributor:  
FAST POLAND Sp. z o. o.  
Kwietniowa 36  
05-090 Wypędy, POLAND

Distributor:  
FAST HUNGARY Kft.  
H-2310 Szigetszentmiklós  
Kántor utca 10, HUNGARY

**PHILCO**<sup>®</sup> 

**is a pending or registered trademark of Electrolux Home Products, Inc. and used under a license from Electrolux Home Products, Inc.**