

# SENCOR®

SRV 9150WH



ROBOTIC VACUUM CLEANER

Translation of the original manual



# SENCOR®

## SRV 9150WH



**A**

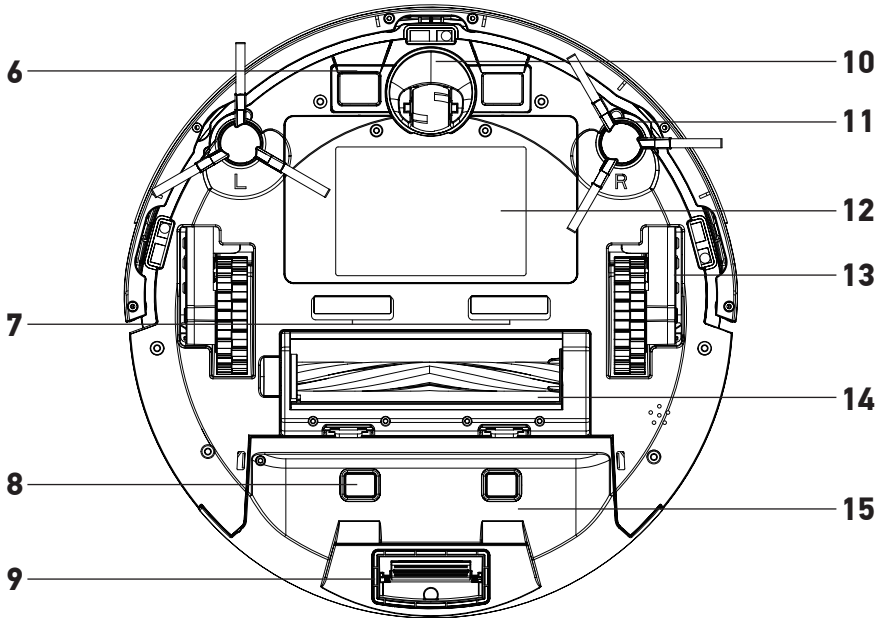
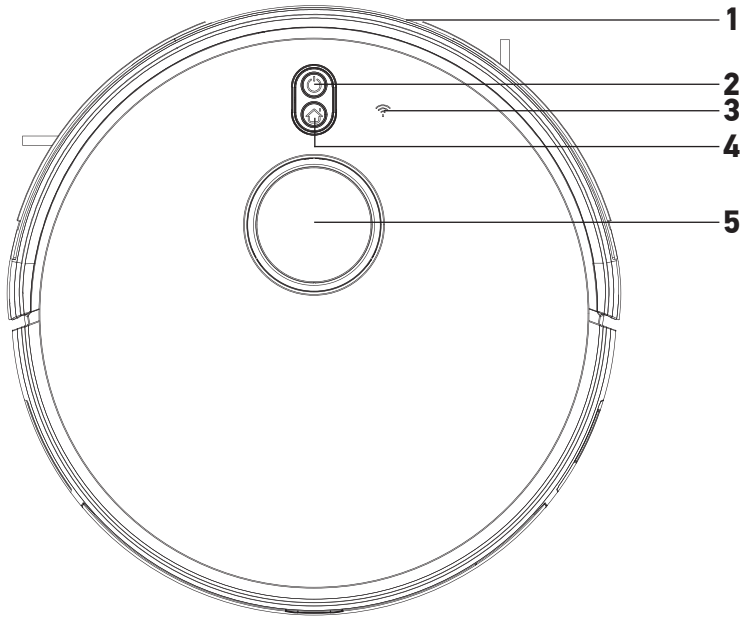

16

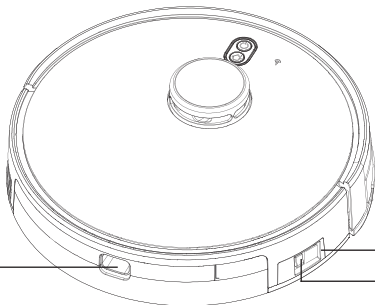

17  
18



19



20



21

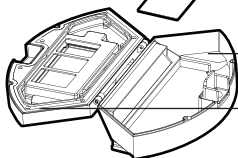

22

23

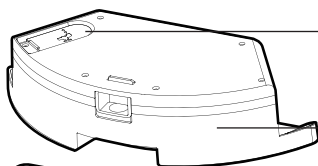

24

25



26

27

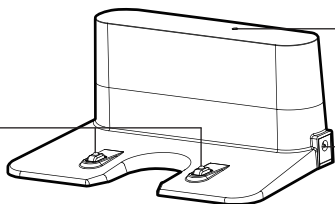

28

29

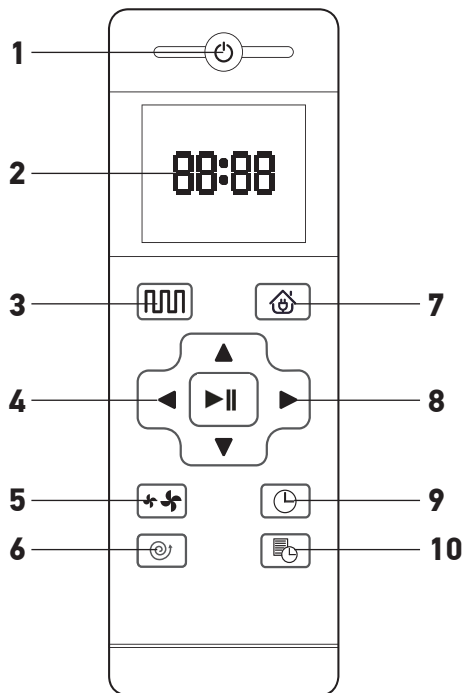
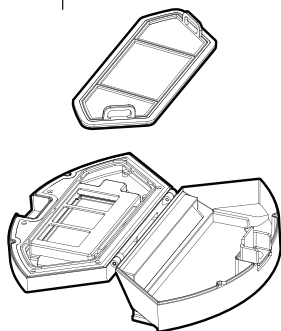
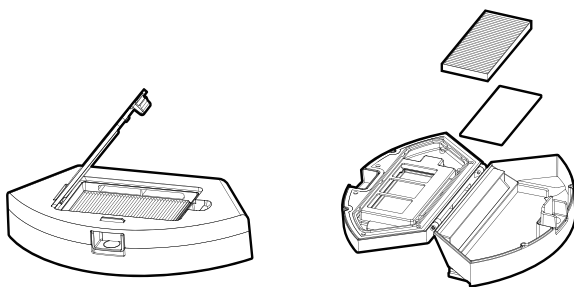
**B****C1****C2**

**D**

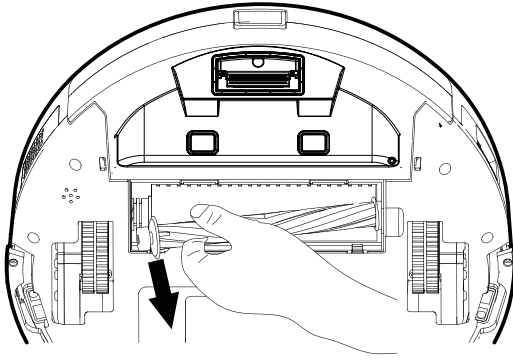

# EN Robotic vacuum cleaner

## Important safety instructions

### READ CAREFULLY AND STORE FOR FUTURE USE.

- This appliance may be used by children 8 years of age and older and by persons with physical, sensory or mental impairments or by inexperienced persons, if they are properly supervised or have been informed about how to use the product in a safe manner and understand the potential dangers.
- Children must not play with the appliance. Cleaning and maintenance performed by the user must not be performed by unsupervised children.
- In the event that the power adapter or the power unit are damaged, have them repaired at a professional service centre to prevent causing a dangerous situation. It is forbidden to use the appliance if it has a damaged power adapter or power unit.
- Prior to cleaning or maintenance, always disconnect the appliance from the power socket and turn it off using the power switch.
- The appliance must only be used with the power adapter and power unit that came with it.



#### **WARNING:**

Do not use the power unit or the power adapter for charging batteries or appliances that are not intended for it.

- The power adapter of the power unit is connected only to a power socket with a protective contact.

## Electrical safety

- Before connecting the adapter to a power socket check that the technical details on the rating label match the electrical voltage in the socket.
- Connect the power adapter only to a properly grounded power socket. Do not use an extension cord.
- Do not disconnect the power adapter from the power socket by pulling on the power cord. This could damage the power adapter or the power socket. Disconnect the power adapter from the power socket by pulling on the plug.
- Do not place the power cord of the power adapter over sharp objects. Make sure that the power cord does not hang over the edge of a table and that it is not touching a heated or hot surface.
- It is forbidden to use a power adapter with a damaged plug or power cord. For a replacement power adapter, please contact an authorised service centre.
- Never use the power adapter supplied with this appliance for any other purposes.
- Keep the power adapter and its power cord dry.
- Do not connect and disconnect the power adapter cord to and from the power socket with wet hands.
- Do not uncover the electronic parts of the robotic vacuum cleaner or its battery. They do not contain any components repairable by the user. Have the appliance serviced by qualified persons.
- To avoid any injury by electrical shock, do not spray the robotic vacuum cleaner, the power unit or the power adapter with water and do not submerge these in water or any other liquid.
- If you will not be using the robotic vacuum cleaner for an extended period of time, take out the battery. Prior to taking out the battery, ensure that the robotic vacuum cleaner is disconnected from the power supply and that it is turned off using the power switch.
- Do not use the robotic vacuum cleaner when it is not working correctly, if it has been damaged or has been submerged in water.
- To avoid the danger of injury by electrical shock, do not repair the robotic vacuum cleaner yourself or make any adjustments to it. Have all repairs performed at an authorised service centre. Tampering with the robotic vacuum cleaner during the warranty period may void the warranty.
- Prior to cleaning or maintenance, always disconnect the robotic vacuum cleaner from the power socket and turn it off using the power switch.

## Safety during use

- This robotic vacuum cleaner is designed for use in households, offices and similar types of areas. Do not use it in industrial surroundings or outdoors.
- The robotic vacuum cleaner is not intended for vacuuming water and therefore must not be used in damp or wet areas, for example in laundries, bathrooms or around swimming pools. If it were to come into contact with water, the internal electronics of the vacuum cleaner would be destroyed.
- Do not use the robotic vacuum cleaner to vacuum the following items:
  - smouldering cigarettes, burning or flammable items, matches or ash;
  - water and other liquids;
  - sharp items, e.g. splinters, needles, pins, etc.;
  - flour, wall plaster and other building materials;
  - larger pieces of paper or plastic bags, which can easily block the suction hole.
- Do not expose the robotic vacuum cleaner to direct sunlight and do not place it near an open fire or appliances that are a source of heat.
- Do not use the robotic vacuum cleaner on narrow raised surfaces such as tables, wardrobes, etc. If the vacuum cleaner does not have sufficient space for manoeuvring, it may fall and be damaged.
- Only use the robotic vacuum cleaner with the original accessories from the manufacturer.
- Ensure that the robotic vacuum cleaner has a dust filter correctly installed in the dust container before use.
- Before putting the robotic vacuum cleaner into operation, check that the entry door into your apartment or house is closed. From the floor surfaces, remove clothing, paper, toys, power or extension cords and other items that the vacuum cleaner could suck in or catch. Lift curtains and drapes that reach to the floor so that they do not get caught in the vacuum cleaner.
- Do not place any items on to the robotic vacuum cleaner and do not step or sit on it.
- If the robotic vacuum cleaner is running, watch out for children and household pets.
- When the robotic vacuum cleaner is running, ensure that the air vents are not covered and that the suction hole is not blocked. Otherwise, the robotic vacuum cleaner may be damaged.
- Adhere to the instructions contained in this user's manual when performing cleaning and maintenance tasks.
- Do not push on the laser navigation module or attempt to lift its cover. This could damage the module.
- Do not look into the light of the UV lamp and do not point the UV lamp at eyes.

## Laser

- The laser sensor meets the laser safety class according to standard EN 60825-1.
- When using, handling or performing maintenance tasks on the robotic vacuum cleaner with a laser sensor, always adhere to the following instructions:
  - Prior to any handling, turn off the robotic vacuum cleaner using the power switch.
  - Do not point the laser beam at people.
  - Do not look into the direct or reflected beam of the laser.
  - Modifications or repairs of the laser sensor that are not performed by an authorised service centre are forbidden.





### Warning:

Not following the instructions contained in this user's manual may result in dangerous irradiation!



- Thank you for purchasing a SENCOR brand product and we hope that you will be happy with it.
- Prior to using this appliance, please read the user's manual thoroughly, even in cases, when one has already familiarised themselves with previous use of similar types of appliances. Only use the appliance in the manner described in this user's manual. Keep this user's manual in a safe place where it can be easily retrieved for future use. In the event that you hand this appliance over to somebody else, make sure to also include this user's manual. We recommend saving the original cardboard box, packaging material, purchase receipt and responsibility statement of the vendor or warranty card for at least the duration of the legal liability for unsatisfactory performance or quality. In the event of transportation, we recommend that you pack the appliance in the original box from the manufacturer.
- Carefully unpack the appliance and take care not to throw away any part of the packaging before you find all the parts of the appliance.
- The remote control facilitates convenient control, enabling the vacuum cleaner to be turned on and off, to be set to the automatic cleaning mode, to select an operating mode, to send the robotic vacuum cleaner to the charging station or to set scheduled cleaning.
- The vacuum cleaner is equipped with GYRO MAPPING function (orientation in space), which can identify the space geometry of a room in which it is cleaning, thereby the vacuum cleaner is able to better clean the floor. The vacuum cleaner is also equipped with laser navigation by means of which it maps out each room and then starts to clean it systematically. Both functions are built-in and cannot be affected in any way.
- The vacuum cleaner is equipped with a UV-C light that removes potentially infectious organisms from the cleaned surfaces. Do not shine this light at people or pets.

### DESCRIPTION OF THE VACUUM CLEANER AND ITS ACCESSORIES

<b>A1</b> Bumper bar	<b>A17</b> Power adapter plug connection socket
<b>A2</b>  button (On/Off)	<b>A18</b> Main switch
<b>A3</b> Wi-Fi indicator	<b>A19</b> Coarse filter
<b>A4</b>  button (home)	<b>A20</b> HEPA filter
<b>A5</b> Laser module	<b>A21</b> Foam filter
<b>A6</b> Front charging contacts	<b>A22</b> Internal area for dust container
<b>A7</b> UV lamp	<b>A23</b> Dust container lid
<b>A8</b> Rear charging contacts	<b>A24</b> Water tank lid
<b>A9</b> Lock for opening the dust container	<b>A25</b> Water tank
<b>A10</b> Front swivel wheel	<b>A26</b> Mop
<b>A11</b> Side brushes	<b>A27</b> Charging contacts
<b>A12</b> Battery cover	<b>A28</b> Charging status indicator
<b>A13</b> Wheels	<b>A29</b> Power adapter plug connection socket
<b>A14</b> Suction hole with rotary brush	<b>A30</b> Power adapter (not shown)
<b>A15</b> Dust container	
<b>A16</b> Dust container release button	

### REMOTE CONTROL

<b>B1</b> On/Off button	<b>B6</b> Spiral cleaning button
<b>B2</b> Display	<b>B7</b> Return to charging station button
<b>B3</b> Smart cleaning button	<b>B8</b> Direction buttons
<b>B4</b> Confirm/start vacuum cleaner button	<b>B9</b> Clock set button
<b>B5</b> Suction power adjustment button	<b>B10</b> Scheduled cleaning setting button

### PURPOSE OF USE AND FEATURES OF THE ROBOTIC VACUUM CLEANER

- The robotic vacuum cleaner is intended for cleaning various types of hard floors such as wooden or laminate floating floors, tiles, vinyl, etc. and carpets with a low pile height. While vacuuming, it effectively combines various routes to optimally clean the entire floor area.
- The suction hole effectively removes hair, animal fur, etc. The two side rotary brushes brush dirt out of hard-to-reach places along walls and furniture and out of corners. The motorised rubber wheels protect sensitive floors against scratching and can travel over threshold strips up to a height of 1.5 cm and ride on to a 2 cm high carpet.
- The suspended bumper enables the vacuum cleaner to dampen the approach to an obstacle and to efficiently clean around it. The infrared sensors in the front bumper prevent the robotic vacuum cleaner from colliding with obstacles. Safe operation in rooms with stairs is made possible by the bottom anti-stair-fall sensors.

### PREPARING THE ROBOTIC VACUUM CLEANER

- Take the robotic vacuum cleaner and all its accessories out of the packaging. Check that you have taken out all the parts.
- Check the robotic vacuum cleaner and its accessories for damage.
- Remove the protective film from the robotic vacuum cleaner and the accessories.

### Installing the side rotary brushes

- The side rotary brushes are intended for smooth floor surfaces and ensure effective cleaning in corners, along walls and furniture.
- Turn the vacuum cleaner upside down. Gradually push in the rotary brushes precisely and with force on to the pins that are intended for them. While doing this, make sure that the marks **L** and **R** both on the brushes and on the vacuum cleaner match. The correct location of the brushes is indicated by a click. Turn the vacuum cleaner back over.
- When using the vacuum cleaner to clean rooms with carpets, remove the rotary brushes. When removing them, proceed in the reverse sequence to their installation.

### Inserting and removing the battery

- The robotic vacuum cleaner is equipped with a Li-ion battery. If the battery is packed separately, it is necessary insert it into the vacuum cleaner before first use. Use only the original battery type.
- Make sure that the vacuum cleaner is turned off with the main switch. Turn the vacuum cleaner upside down and screw off the cover.
- Remove the vacuum cleaner connector from the battery compartment. Connect the battery connector to it. The battery can only be connected in one direction.
- Screw the cover back on and turn the vacuum cleaner back over to the operating position.
- Remove the battery in reverse sequence. Prior to removing it, always check that the vacuum cleaner is turned off using the main switch. The fabric strips on the body of the battery make battery removal easier.
- When the vacuum cleaner will not be used for an extended period of time, take out the battery and store it in a dry, clean and cool place out of children's reach.

### LOCATION OF THE CHARGING STATION

- The charging station serves to automatically recharge the battery and the vacuum cleaner must have good access to it.
- Locate the charging station against a wall on a hard, even and dry surface within reach of a power socket. Make sure that there are no stairs or obstacles within a distance of 1 m on the left and right of the charging station and within a distance of 2 m in front of the charging station, that would prevent the vacuum cleaner from finding the charging station and docking successfully.

- Insert the power adapter plug into the socket of the charging station, and insert the adapter plug into a power socket. Place the power cord in such a way that it does not tangle into the cleaning brushes of the vacuum cleaner.
- In the event that the vacuum cleaner is not used for an extended period of time, disconnect the charging station from the power socket and store it in a dry, clean and cool place.



**Note:**

The cleaning process may be interrupted at any time by pressing the  button on the remote control or by sending a command using the application. The vacuum cleaner will finish cleaning, then seek out the charging station and dock in it.

**CHARGING THE ROBOTIC VACUUM CLEANER**

- It is possible to charge the vacuum cleaner in the charging station, which the vacuum cleaner will automatically seek out after finishing cleaning or if it registers a low battery charge level, or it is possible to charge it directly by connecting the power adapter plug into the socket on the side of the robotic vacuum cleaner.
- Always make sure that the main power switch is in the "I" position before charging. Otherwise, charging will not be possible.

**Charging the vacuum cleaner for the first time**

- Before first use, it is necessary to fully charge the robotic vacuum cleaner.
- Allow the robotic vacuum cleaner to charge for 12 hours. We recommend charging it by directly connecting the power adapter plug.
- To extend the lifespan of the built-in battery, allow the vacuum cleaner to discharge fully before recharging it again.

**Charging in the charging station**

- Check that the charging station is correctly positioned and connected to a power socket according to chapter Location of the charging station.
- Set the main power switch to position "I" (On).
- Grasp the vacuum cleaner and manually place it into the charging station so that the charging contacts on the underside of the vacuum cleaner and the charging contacts on the charging station are connected. When the contacts are connected, the charging process will start.

**Direct charging from the power adapter**

The vacuum cleaner can be charged directly by connecting the power adapter plug into the socket on the side of the vacuum cleaner. Insert the power adapter plug into a power socket.

**Automatic charging**

- The robotic vacuum cleaner utilises the automatic charging function whenever it finishes cleaning and in cases, where during operation, it detects low power on the built-in battery.
- The robotic vacuum cleaner will start to actively seek out the charging station. It is thus important that it is always connected to a power source and is freely accessible for the vacuum cleaner so that it can dock in it.
- After docking in the charging station, the charging cycle will commence. A complete charge takes approximately 4 to 6 hours. The actual charging time depends on the power level of the battery at the start of the charging process.
- A full charge will provide up to 120 minutes of operation.
- Once the charging base is connected to the power socket, the green light on the charging base flashes to indicate that the charging base is in use. This status does not change even when the robotic vacuum cleaner is recharged.
- In the event that the charging contacts are disconnected during the charging cycle, the vacuum cleaner will move away from the charging station and then re-dock itself to resume the charging process, unless it is prevented from doing so by an obstacle.
- In the event of a power outage, the charging cycle will be interrupted and will continue after the power supply is renewed.
- In the event that the maximum charging current is exceeded, the charging station will automatically interrupt the charging cycle.



**Note:**

In the event that the robotic vacuum cleaner is discharged completely, e.g. because the vacuum cleaner failed to seek out or dock in the charging station, it is necessary to manually place it into the charging station.

**REMOTE CONTROL**

- Push down the latch of the cover on the rear side of the remote control to release it and remove the cover.
- Insert two type AAA (1.5 V) batteries into the remote control. When inserting the batteries ensure the correct polarity as shown inside the battery compartment. Put the cover back on and click it into place.
- In the event that the batteries are flat, replace them with new ones. Do not combine various types of batteries or new and old batteries.
- The signal range of the remote control is approximately 6 m.
- When replacing batteries, first remove the flat batteries and then insert the new ones.



**Note:**

Never combine flat and new batteries nor various types of batteries.

**Operating the robotic vacuum cleaner**





**Note:**

Before starting the vacuum cleaner, always check that the dust container and the HEPA filter or the mop attachment are inserted in place.

**Turning on the robotic vacuum cleaner**

- Set the main power switch to position I (On) to turn on the vacuum cleaner.
- Press the  button on the vacuum cleaner or on the remote control and the vacuum cleaner will start.

**Pausing the cleaning process**

- Press the  button on the vacuum cleaner or on the remote control and the vacuum cleaner will stop. To restart the vacuum cleaner, press the  button again.

**Sleep mode**

- The sleep mode serves to save the battery's capacity. The robotic vacuum cleaner will enter the sleep mode automatically after three minutes of inactivity.
- To wake the vacuum cleaner from the sleep mode to the stand-by mode, press button  on the vacuum cleaner or on the remote control.



**Note:**

When the vacuum cleaner is in sleep mode, it is not possible to wake it up using the mobile phone application. In the sleep mode, it only responds to button .

**Turning off the robotic vacuum cleaner**

- If you wish to completely turn off the vacuum cleaner, set the main switch to position O (Off). When the vacuum cleaner is turned off, it will not respond to any button.

**SELECTING THE ROBOTIC VACUUM CLEANER CLEANING MODE**

- Before starting the cleaning process, check that the entry door into your apartment or house is closed. From the floor surfaces, remove clothing, paper, toys, power or extension cords and other items that the vacuum cleaner could suck in or catch. Lift curtains and drapes that reach to the floor so that the vacuum cleaner does not catch them.

**Tip:**

When vacuuming in a new environment for the first time, carefully observe the movement of the vacuum cleaner. You can thereby recognise problematic obstacles and remove them for the next cleaning session.







**Smart cleaning mode**

- Press the  button on the remote control. The vacuum cleaner will enter the smart cleaning mode in which the vacuum cleaner cleans in Letter-S form based on the parameters of the room. As soon as the vacuum cleaner finishes cleaning, it will seek out the charging station and dock in it.

**Spiral cleaning mode**

- Press the  button on the remote control. The vacuum cleaner will enter the spiral cleaning mode. It will determine its position by means of a starting point, and will start vacuuming in clockwise circles. The radius will gradually increase up to a maximum distance of 1.5 m. Then it will turn around 180° and will travel anticlockwise reducing its radius until it reaches the starting point.
- In the event that during the cleaning process the vacuum cleaner impacts an obstacle, it will turn around 180° and will continue cleaning from a new starting point.
- Do not use this cleaning mode when the vacuum cleaner is located near or directly in a corner. This could cause it to become stuck. If this happens, the automatic cleaning mode is cancelled after about 2 to 3 minutes.











**PLANNING CLEANING (USING THE REMOTE CONTROL)****Setting the clock**

- Press the  button.
- Use the direction buttons to set the hours and minutes. Use buttons   to set the numerical value and buttons   to toggle between hours and minutes.
- To confirm, press the  button.

**Note:**

We recommend setting the time based on actual time.

**Scheduling cleaning**





- Press the  button. Icon  will start flashing on the display.
- Use the direction buttons to set the time when the scheduled cleaning should start. Use buttons   to set the numerical value and buttons   to toggle between hours and minutes.
- To confirm, press the  button. The setting will be saved and the icon  will be lit on the display.
- The robotic vacuum cleaner will turn on and start cleaning at the set time.
- If you need to cancel the setting, hold down button  for 3 seconds and the  icon will disappear from the display.

**SETTING THE SUCTION POWER**

- Press the  button to set the suction power of the vacuum cleaner. You can set standard suction power or high suction power.

**DIRECTION BUTTONS**

When the vacuum cleaner is in the stand-by mode, the direction buttons are used to move it around as follows:

-  move forward
-  turn around 180°
-  turn left
-  turn right

Releasing the button will stop the movement of the vacuum cleaner and it will switch to the stand-by mode.

**Note:**

In the clock setting and scheduled cleaning time setting mode, the direction buttons are used to set the time and to toggle between hours and minutes.

**MOP UNIT**

The mop unit is used for wiping smooth floor areas. The water tank is equipped with an electronically-controlled water pump that automatically doses the water on to the mop and also stops dosing water at the end of the cleaning process to prevent water from leaking on to the floor or the charging station.

**Attention:**

Only use the mop unit intended for this type of robotic vacuum cleaner. Do not use the vacuum cleaner without attaching the mop. The mop unit is not intended for cleaning carpets.

- Remove the water tank cap and pour water into it.
- Dip the mop in clean water and wring it out. This will speed up the soaking process.
- Put the mop on to the mop unit. Thanks to the Velcro zip, it is easy to attach the mop to the mop unit.
- Insert the mop unit into the vacuum cleaner.

**Warning:**

Take the mop unit off the vacuum cleaner when charging it.

**CONTROL VIA THE SENCOR HOME APPLICATION**

- The robotic vacuum cleaner can be controlled via the Sencor HOME application.
- Download the application to your smart phone, register yourself and control the vacuum cleaner via the application. It enables you to select the cleaning mode, stop the cleaning process or send the vacuum cleaner to the charging station; it provides an overview of how much time was spent cleaning and about the condition of the vacuum cleaner.

**Note:**

The robotic vacuum cleaner supports Wi-Fi in the 2.4 GHz frequency band. If you are unsure about which standards are used by your Wi-Fi network and your router, please contact your internet service provider or the manufacturer of the router.



- If you already have the application installed, add the vacuum cleaner to your devices.

**Adding the vacuum cleaner to the device list via a QR code**

- The robotic vacuum cleaner can also be added to the Sencor HOME application using the QR code provided below. On the home screen of the application, click on the "+" icon and on the add device screen, click on the icon  in the top right hand corner.

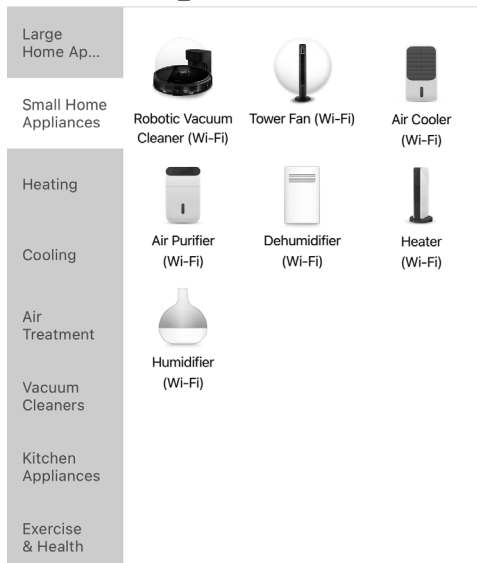

#### QR code for adding the control panel of the vacuum cleaner to the application Sencor HOME



#### Manually adding the robotic vacuum cleaner to the device list

- On the main screen, click on "Add device" or on the "+" in the top right hand corner.
- A screen with appliance categories will appear together with a list of appliances.
- Click on "Robotic vacuum cleaners" and from the list, select "Robotic vacuum cleaner (Wi-Fi)".
- On the next screen, you will be asked to select a Wi-Fi network. Select a network with a frequency of 2.4 GHz, enter the password and click on "Next". Ensure that the robotic vacuum cleaner is ready for pairing. It is important that the robotic vacuum cleaner is connect to a power source and is in stand-by mode. The Wi-Fi indicator will start flashing quickly.
- In the application, confirm that the Wi-Fi icon is flashing quickly. Ensure that the "AP Mode" is selected in the top right. Then click on "Next". If the "EZ mode" is set, click on it and select the "AP mode". If will be necessary to again select a Wi-Fi network - see preceding description.
- The vacuum cleaner will automatically be added to the device list. The Wi-Fi icon will be lit on the display.
- In the device list on the main screen, click on the icon of the vacuum cleaner to enter control interface.

#### CLEANING AND MAINTENANCE

- Prior to cleaning it, always turn off the vacuum cleaner using the power switch.
- For cleaning, never use abrasive cleaning products, solvents, etc.
- Neglecting cleaning and maintenance may negatively affect the working order of the vacuum cleaner and lead to its reduced performance.

#### Dust container and filters

Empty out the dust container after every use and clean it regularly.

- Take the dust container out of the vacuum cleaner, open it and dump out its contents. For hygiene reasons, we recommend doing this away from living areas.
- Remove the coarse filter of the dust container – see figure C1.
- Open the cover and remove the HEPA filter and the foam filter – see figure C2.
- Wipe the dust container using a damp cloth. If it is still heavily soiled, wash the dust container under running water and dry it well.
- Tap out the filters and carefully remove any dust and dirt. Check them for damage and excessive wear and tear. If necessary, replace them with a new ones.



#### Warning:

Do not wash the filters in water. This could damage them.

- Insert the filter back in its place.
- Close the the dust container and insert it into the vacuum cleaner.



#### Attention:

Before putting the vacuum cleaner back into operation, check that the filters are in their place. Otherwise the vacuum cleaner may be damaged.

#### Mop unit

Clean the mop unit after every use. If necessary, pour out any remaining water and allow it to dry out to prevent the growth of unwanted micro-organisms.

- Remove the mop and wash it by hand in lukewarm water with the addition of a small amount of gentle washing powder and allow it to dry naturally.
- Open the cap and pour out any remaining water from the water tank.
- Keep the cap open to allow the water tank to dry out.
- Wipe the outer surface of the water tank with a lightly dampened cloth and then use a clean wiping cloth to wipe it dry.

#### Central rotary brush

- Press down the clip on the cover of the middle rotary brush and take it out of the vacuum cleaner – see figure D.
- Use a dry wiping cloth to clean out the area in which the rotary brush is housed. Check and clean out the suction hole. Dirt and dust that accumulates around the suction hole may reduce the suction power of the vacuum cleaner.
- Remove any dirt and material (dust, wound on hair, animal fur, etc.) from the rotary brush.
- Insert the rotary brush back into the cover and then into the vacuum cleaner.

#### Side rotary brushes

- Take out the rotary brushes by pulling them upwards. Remove any dust and dirt from the location where the brushes were mounted.
- Remove all dust and dirt from the brushes. If necessary you may wash the brushes under running water. If the bristles were deformed while the vacuum cleaner was running, dip them in warm water to allow them to return to their original shape. Allow the brushes to dry before reattaching to the vacuum cleaner.
- After cleaning them, reattach them.



**Note:**

The rotary brushes become worn out when used. After a certain time it is necessary to replace the used brushes with new ones. To order new brushes, please contact your vendor or an authorised service centre.

**Complete robotic vacuum cleaner**

- Regularly wipe the surface of the vacuum cleaner using a soft dry wiping cloth.
- Clean the front swivel wheel, motorised wheels, suction hole, rotary brush and the bottom sensors at least once per week or more frequently.
- First remove any coarser dirt from the front swivel wheel and the motorised wheels. Then clean them around their entire perimeter using a lightly dampened cloth and wipe them dry. Do not forget to also clean the area around the wheels.
- Wipe the sensors on the underside of the vacuum cleaner using a soft dry wiping cloth or cotton bud.

**Storage**

- When not using the vacuum cleaner for an extended period of time, do the following:
- Clean the vacuum cleaner as described in chapter CLEANING AND MAINTENANCE.
- It is recommended to charge the vacuum cleaner every 3 months as this will extend the lifetime of the built-in battery.

**TROUBLESHOOTING**

Problem	Cause	Solution
The vacuum cleaner is not charging itself.	The charging contacts are not touching.	Check that the contacts are touching when inserting the vacuum cleaner into the charging station.
	The charging station is disconnected from the power source.	Insert the power adapter into a power socket and keep the charging station permanently connected.
The vacuum cleaner is stuck in a single location.	The vacuum cleaner has become entangled in wires/cables lying on the ground, in curtains or other foreign objects on the carpet.	The vacuum cleaner will always attempt to free itself on its own, however, we recommend to remove it by hand from the stuck location.
The vacuum cleaner returned to the charging station without completing the cleaning process.	The vacuum cleaner detected a low battery charge level and automatically returned to the charging station to recharge.	This is normal. Allow the vacuum cleaner to recharge.
The vacuum cleaner does not perform the cleaning process automatically as scheduled.	The vacuum cleaner is not switched on and cannot perform the cleaning process as scheduled.	Turn on the vacuum cleaner.
	The vacuum cleaner battery is almost flat.	Allow the vacuum cleaner to recharge.
	The vacuum cleaner has become stuck or is blocked by a foreign object.	Turn off the vacuum cleaner, empty out the dust container. Turn the vacuum cleaner upside down and remove dust and dirt from the wheels and brushes.

The remote control doesn't work. (Recommended distance is 5 m.)	Batteries are flat.	Replace the batteries in the remote control.
	The vacuum cleaner battery is almost flat.	Allow the vacuum cleaner to recharge.
	The remote signal receiver on the vacuum cleaner or the signal transmitter on the remote control is blocked or soiled.	Wipe the signal receiver and transmitter using a clean wiping cloth.
	The remote control signal is being interfered with by another device in its vicinity.	Do not use the remote control in the vicinity of devices with an infrared signal.
Whilst the vacuum cleaner is running, vacuuming locations are being left out, its travel path is chaotic, it is travelling in the opposite direction, the map in the application is showing inaccuracies or is not defined.	The floor is too smooth, the central wheel slides on the floor and the vacuum cleaner travels over low obstacles, thresholds and strips, and this affects its decision making process regarding the cleaning area in the entire home.	We recommend closing the doors of individual rooms and a to allow them to be cleaned individually. The vacuum cleaner is equipped with a function for the identification of a single room. It will return to its starting location.
	The floor is washed and polished or too smooth, which reduces friction between the wheels and the floor.	We recommend cleaning the floor after it has been waxed.
	Cables, foreign objects on the floor affect the operation of the vacuum cleaner.	Prior to starting the vacuum cleaner, it is important to remove from the floor any cables, slippers, toys and other foreign objects to reduce the number of obstacles, which the vacuum cleaner will need to drive around.

**TECHNICAL SPECIFICATIONS**

**Robotic vacuum cleaner**

Dimensions (diameter × height).....	330 × 101 mm
Weight.....	3.1 kg
Operating time per single charge.....	up to 120 min
Dust container capacity.....	600 ml
Water tank capacity.....	350 ml
Laser sensor class.....	I

**Power adapter**

Rated voltage range.....	100–240 V ~
Rated frequency.....	50–60 Hz
Output.....	19 V DC, 0.6 A

**Battery**

Type.....	Li-ion / 14.4 V / 2 600 mAh
Charging time.....	4–6 h

**Charging station**

Input.....	19 V DC, 0.6 A
Output.....	19 V DC, 0.6 A

The declared noise emission level is lower than 75 dB(A), which represents a level A of sound power with respect to a reference sound power of 1 pW.



**Safety class for electrical shock protection:**

Class II – Electrical shock protection is provided by double or heavy-duty insulation.



Product with protection class III: product is built for safety extra-low voltage. Electrical shock protection is provided by safety extra-low voltage.



The product is intended for household use only. The product is not intended for outdoor use.

**EXPLANATION OF TECHNICAL TERMINOLOGY**

**Laser sensor class:**

Very low power lasers or encapsulated lasers. Safe for viewing with the eye for a time of 100 seconds even with the use of optical devices.

**DISPOSAL OF USED BATTERIES**

Prior to handing over the product at a specialised collection facility, it is necessary to ensure that the battery is removed. Prior to removing the battery, turn off the vacuum cleaner using the main switch. Disconnect the battery using the reverse sequence to that described in chapter INSERTING AND REMOVING THE BATTERY.



This symbol indicates that used batteries do not belong in ordinary municipal waste. Hand over used batteries to designated collection points for proper disposal. Correct disposal of batteries will help prevent negative impacts on the environment and human health.

**Disposal in other countries outside the European Union.**

This symbol is valid in the European Union. If you wish to dispose of used batteries, request the necessary information about the correct disposal method from the local authorities or from your vendor.

**INSTRUCTIONS AND INFORMATION REGARDING THE DISPOSAL OF USED PACKAGING MATERIALS**

Dispose of used packaging material at a site designated for waste in your municipality.

**DISPOSAL OF USED ELECTRICAL AND ELECTRONIC EQUIPMENT**



This symbol on products or original documents means that used electric or electronic products must not be added to ordinary municipal waste. For proper disposal, renewal and recycling, hand these appliances over to determined collection points. Alternatively, in some European Union states or other European countries you may return your appliances to the local retailer when buying an equivalent new appliance. Correct disposal of this product helps save valuable natural resources and prevents potential negative effects on the environment and human health, which could result from improper waste disposal. Ask your local authorities or collection facility for more details. In accordance with national regulations penalties may be imposed for the incorrect disposal of this type of waste.

**For business entities in European Union states**

If you want to dispose of electrical or electronic equipment, ask your retailer or supplier for the necessary information.

**Disposal in other countries outside the European Union.**

This symbol is valid in the European Union. If you wish to dispose of this product, request the necessary information about the correct disposal method from the local council or from your retailer.



This product meets all the basic requirements of EU directives related to it.

SENCOR hereby declares that radio device model number SRV 9150WH is in compliance with directive 2014/53/EU. The full wording of the EU Declaration of Conformity is available at the website: [www.sencor.eu](http://www.sencor.eu).

