

# SENCOR®

SWK 7500WH  
SWK 7501BK



ELECTRIC KETTLE  
Translation of the original manual



**SENCOR®**

**SWK 7500WH  
SWK 7501BK**



**A**

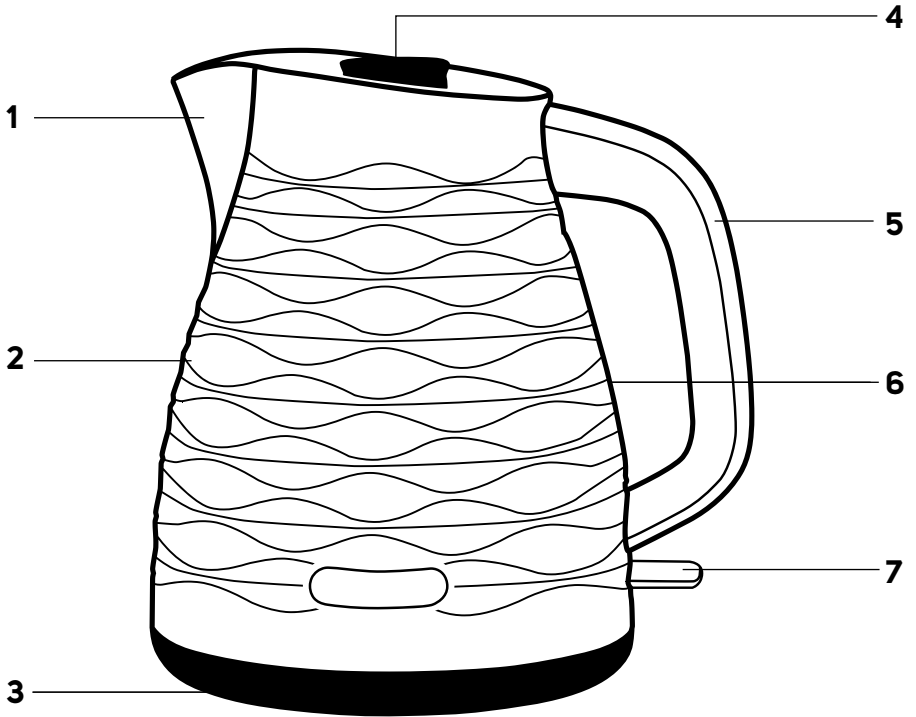

## EN

### DESCRIPTION OF THE APPLIANCE

- A1** Spout with a removable filter inside
- A2** Kettle body
- A3** Base with a central connector
- A4** Removable lid with clip
- A5** Handle
- A6** Water level mark
- A7** On/Off toggle switch (I/O) with power indicator light

## SK

### POPIS SPOTREBIČA

- A1** Výtlevka s vyberateľným filtrom vnútri
- A2** Telo kanvice
- A3** Podstavec so stredovým konektorom
- A4** Odnímateľné veko s úchytkou
- A5** Rukoväť
- A6** Vodoznak
- A7** Prepínač zapnutia/vypnutia (I/O) so svetelnou indikáciou prevádzky

## PL

### OPIS URZĄDZENIA

- A1** Lejek z wymiowanym filtrem w środku
- A2** Korpus czajnika
- A3** Podstawa z centralnym złączem
- A4** Zdejmowana pokrywa z uchwytem
- A5** Rękojeść
- A6** Wskaźnik poziomu wody
- A7** Przełącznik włączenia/wyłączenia (I/O) z sygnalizacją świetlną pracy

## HR

### OPIS UREĐAJA

- A1** Grič s odvojivim filtrom
- A2** Kućište kuhala
- A3** Postolje sa središnjim priključkom
- A4** Odvojivi poklopac s korčom
- A5** Ručka
- A6** Oznaka razine vode
- A7** Prekidač za uključivanje/isključivanje (I/O) sa svjetlosnim indikatorom uključenosti

## CZ

### POPIS SPOTŘEBIČE

- A1** Výtlevka s vyjímatelným filtrem uvnitř
- A2** Tělo konvice
- A3** Podstavec se středovým konektorem
- A4** Odnímatelné víko s úchytkou
- A5** Rukojeť
- A6** Vodoznak
- A7** Přepínač zapnutí/vypnutí (I/O) se světelnou indikací provozu

## HU

### A KÉSZÜLÉK RÉSZEI

- A1** Kiöntő csőr, kivehető szűrővel
- A2** Kanna
- A3** Talp, középcsatlakozóval
- A4** Levehető fedél, fogantyúval
- A5** Fogantyú
- A6** Vízsztint kijelző
- A7** Be/kí kapcsoló (I/O), működésjelző lámpával

## RU

### ОПИСАНИЕ ЭЛЕКТРОПРИБОРА

- A1** Носик со съёмным внутренним фильтром
- A2** Корпус чайника
- A3** Подставка с центральным разъёмом
- A4** Съёмная крышка с держателем
- A5** Ручка
- A6** Указатель уровня
- A7** Переключатель включения/выключения (I/O) со световой индикацией работы

## GR

### ΠΕΡΙΓΡΑΦΗ ΤΗΣ ΣΥΣΚΕΥΗΣ

- A1** Στόμιο με αφαιρούμενο φίλτρο στο εσωτερικό
- A2** Σώμα βραστήρα
- A3** Βάση με κεντρικό σύνδεσμο
- A4** Αφαιρούμενο καπάκι με κλιπ
- A5** Λαβή
- A6** Ένδειξη στάθμης νερού
- A7** Διακόπτης εναλλαγής On/Off (I/O) ενδεικτική λυχνία ισχύος

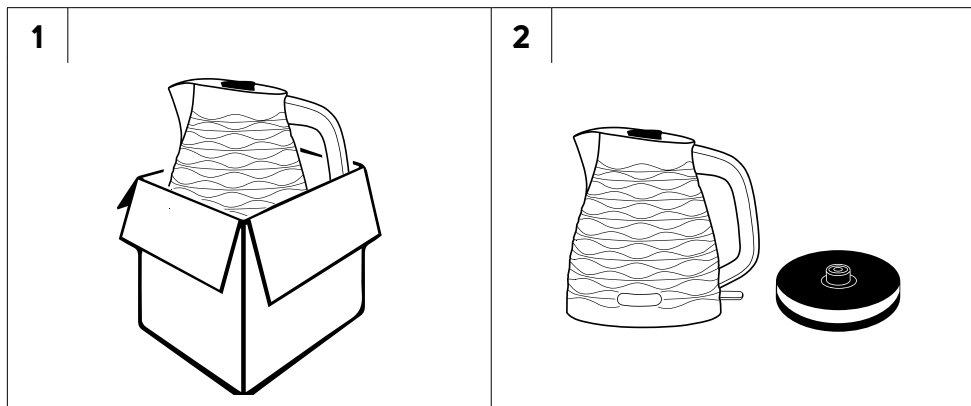

EN - BEFORE FIRST USE / CZ - PŘED PRVNÍM POUŽITÍM / SK - PRED PRVÝM POUŽITÍM / HU - AZ ELSŐ HASZNÁLTÁBA VÉTEL ELŐTT  
/ PL - PRZED PRZYSTĄPIENIEM DO EKSPLOATACJI / RU - ПЕРЕД НАЧАЛОМ ИСПОЛЬЗОВАНИЯ / HR - PRIJE PRVE UPOTREBE  
/ GR - ΠΡΙΝ ΑΠΟ ΤΗΝ ΠΡΩΤΗ ΧΡΗΣΗ

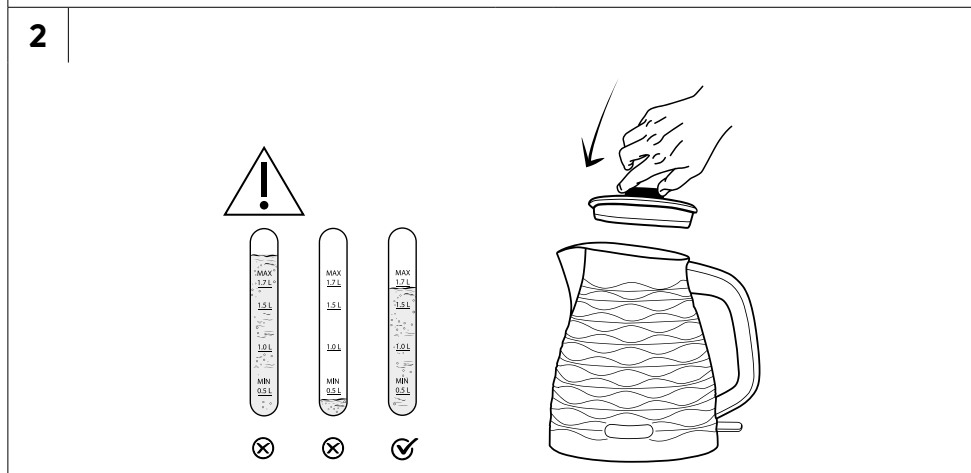
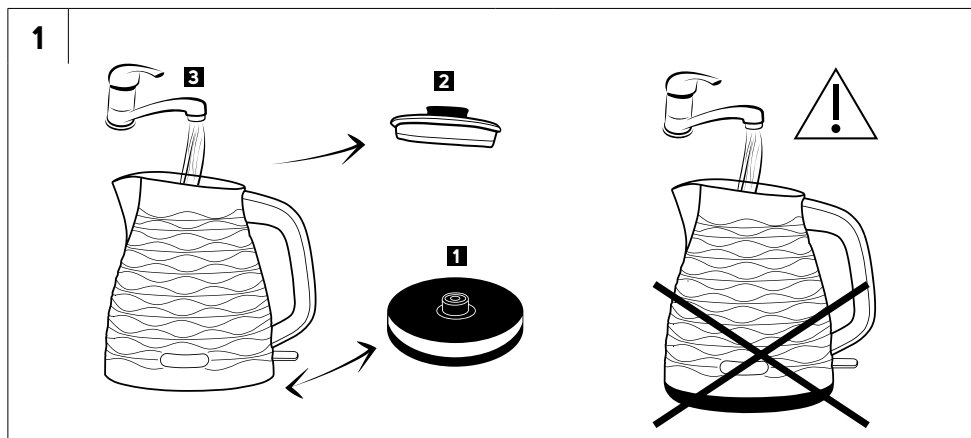

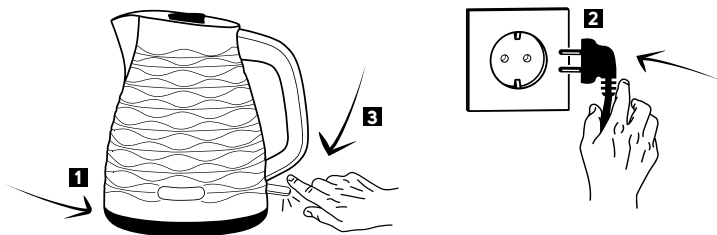
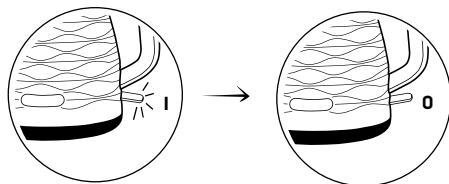
**3****4**

EN - AUTOMATIC SHUT-OFF / CZ - AUTOMATICKÉ VYPNUTÍ  
/ SK - AUTOMATICKÉ VYPNUTIE / HU - AUTOMATIKUS  
KIKAPCSOLÁS / PL - WYŁĄCZANIE AUTOMATYCZNE  
/ RU - АВТОМАТИЧЕСКОЕ ВЫКЛЮЧЕНИЕ  
/ HR - AUTOMATSKO ISKLJUČIVANJE  
/ GR - ΑΥΤΟΜΑΤΗ ΑΠΕΝΕΡΓΟΠΟΙΗΣΗ

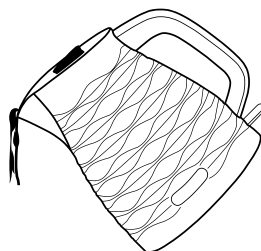
**5**

1-5: 2x - 3x

1

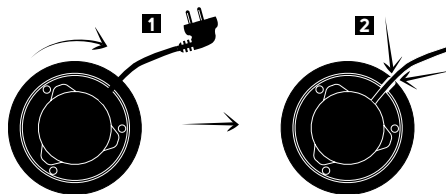

2

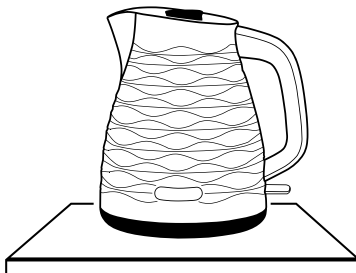

3

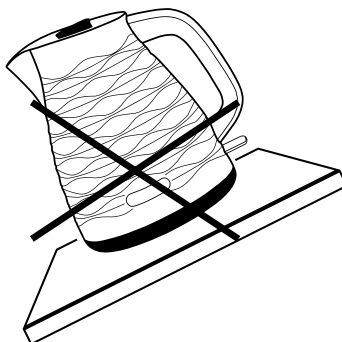

4

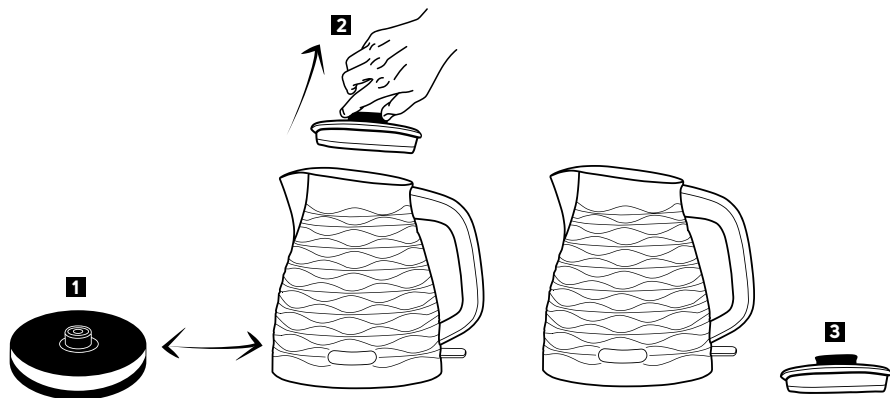

5

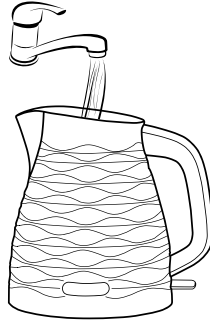

6

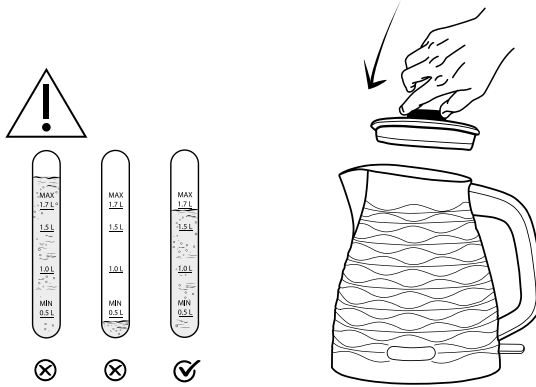

7

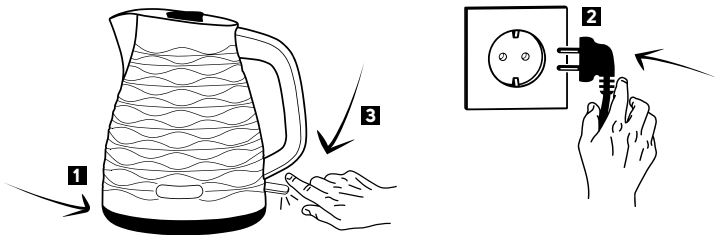



8

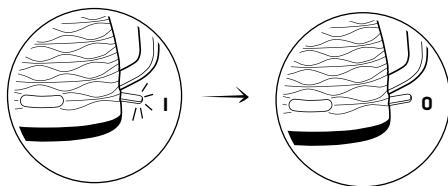

EN - AUTOMATIC SHUT-OFF / CZ - AUTOMATICKÉ VYPNUTÍ  
 / SK - AUTOMATICKÉ VYPNUTIE / HU - AUTOMATIKUS  
 KIKAPCSOLÁS / PL - WYŁĄCZANIE AUTOMATYCZNE  
 / RU - АВТОМАТИЧЕСКОЕ ВЫКЛЮЧЕНИЕ  
 / HR - AUTOMATSKO ISKLJUČIVANJE  
 / GR - ΑΥΤΟΜΑΤΗ ΑΠΕΝΕΡΓΟΠΟΙΗΣΗ

9

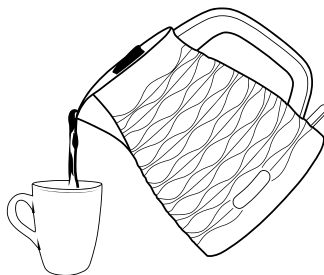

10

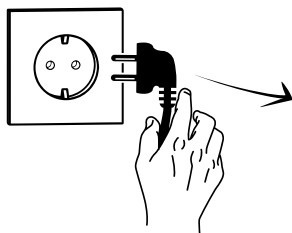

EN - PREMATURE KETTLE SHUT OFF / CZ - PŘEDČASNÉ VYPNUTÍ KONVICE / SK - PREDČASNÉ VYPNUTIE KANVICE / HU - A VÍZFORRALÓ  
 KORÁBBI KIKAPCSOLÁSA / PL - WCZEŚNIEJSZE WYŁĄCZENIE CZAJNIKA / RU - ПРЕЖДЕВРЕМЕННОЕ ВЫКЛЮЧЕНИЕ ЧАЙНИКА  
 / HR - PRIJEVREMENO ISKLJUČIVANJE KUHALA / GR - ΠΡΟΩΡΗ ΑΠΕΝΕΡΓΟΠΟΙΗΣΗ ΒΡΑΣΤΗΡΑ

1

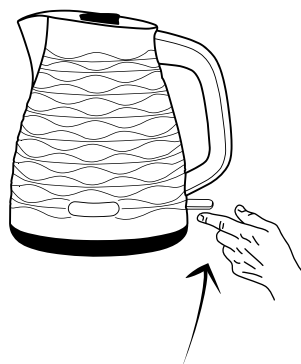

# EN Electric kettle

## Important safety instructions

### **READ CAREFULLY AND STORE FOR FUTURE USE.**

- This appliance may be used by children 8 years of age and older and by persons with physical, sensory or mental impairments or by inexperienced persons, if they are properly supervised or have been informed about how to use the product in a safe manner and understand the potential dangers.
- Children must not play with the appliance.
- Cleaning and maintenance performed by the user must not be performed by children unless they are older than 8 years of age and under supervision.
- Keep the appliance and its power cord out of reach of children younger than 8 years of age.
- In the event that the power cord is damaged, have it repaired at a professional service centre to prevent causing a dangerous situation. It is forbidden to use the appliance if it has a damaged power cord.
- This appliance is intended for home use. Likewise, this appliance is intended for personal non-commercial use in locations such as:
  - kitchens in stores, offices and other workplaces;
  - in agriculture;
  - guests of hotels, motels and other accommodation locations;

- in bed and breakfast establishments.
- Do not wash the kettle or its base stand under running water and do not submerge it or its base stand in water or another liquid.
- If the kettle is overfilled, then hot water may splash out.



**WARNING:**

Do not open the lid while the water is boiling.

- Only use the kettle with the supplied base stand. Do not use the base stand with other types of appliances.



**ATTENTION:**

Make sure that the appliance is turned off before removing it from the base stand.



**WARNING:**

Avoid spillage of water on the connector.

- Rinse out the inner surface of the kettle with clean water. Follow the cleaning instructions in chapter "Cleaning and maintenance".



**WARNING:**

Incorrect use may result in a risk of injury.

- The surface of the heating element retains residual heat after use. Do not touch the hot surface.

- Before connecting the kettle to a power socket check that the nominal voltage matches the electrical voltage in the socket.
- Fully unwind the power cord before use. Make sure the power cord does not hang over the edge of a table or that it is not touching a hot surface or sharp objects.
- Connect the kettle only to a properly grounded socket.
- Do not place the kettle on window sills, kitchen sink drainboards or unstable surfaces. Always place it on a stable, even and dry surface.
- Do not place the kettle on an electric or gas stove or in its vicinity, do not place it in the vicinity of an open fire or an appliance that is a source of heat.
- Never use the kettle in the near vicinity of a bath, shower or swimming pool.
- Do not use the kettle outdoors or in an excessively wet/humid environment. During its use, there must be a sufficient area around the kettle to enable air circulation. Never cover the appliance when using it, when it is connected to a power socket or when it is hot or filled with water.
- Use the kettle exclusively for boiling drinking water. Do not use it to heat other liquids or foodstuffs.
- Do not fill the kettle when it is located on the base stand. Take the kettle off the base stand before filling it. When filling it, make sure that the water level covers at least the minimum mark and does not go past the maximum mark.
- Check that the lid is securely closed before starting the kettle.
- Do not turn on the kettle when it is empty. Incorrect use may negatively affect its lifetime. For the event that it is accidentally started without water, the kettle is equipped with a safety mechanism that protects it against damage.
- Use the handle for lifting and carrying.
- Do not tamper with the lid while the water is boiling.
- Be especially careful when pouring water out of the kettle to avoid scalding by the boiling water or steam.
- Prior to refilling it, empty the contents of the kettle.
- Do not pour icy cold water into the hot kettle.
- Always disconnect the kettle from the power socket when not using it, when leaving it without supervision, before moving or cleaning it.
- Disconnect the kettle from the power socket by gently pulling the plug of the power cord, and not the power cord itself. Otherwise, this could damage the power cord or the socket.
- To avoid the danger of injury by electrical shock, do not repair the kettle yourself or make any adjustments to it. Have all repairs or adjustments performed at an authorised service centre. By tampering with the appliance, you risk voiding your legal rights arising from unsatisfactory performance or quality warranty.

- Thank you for purchasing a SENCOR brand product and we hope that you will be happy with it.
- Prior to using this appliance, please read the user's manual thoroughly, even in cases, when one has already familiarised themselves with previous use of similar types of appliances. Only use the appliance in the manner described in this user's manual. Keep this user's manual in a safe place where it can be easily retrieved for future use.
- We recommend saving the original cardboard box, packaging material, purchase receipt and responsibility statement of the vendor or warranty card for at least the duration of the legal liability for unsatisfactory performance or quality. In the event of transportation, we recommend that you pack the appliance in the original box from the manufacturer.

#### PROTECTION AGAINST OVERHEATING WHEN TURNED ON WITHOUT WATER

- In the event that you turn on the kettle without water inside or if the kettle is filled with an insufficient amount of water, then it will turn off automatically after a certain time. The kettle can be started again after several minutes, once the heating bottom has cooled down.

#### CLEANING AND MAINTENANCE

- Completely empty out the contents of the kettle after every use.
- Disconnect the power plug from the power socket and allow the appliance to cool down before cleaning it.
- For cleaning, do not use cleaning products with an abrasive effect, solvents, etc. that could damage the appliance. No part of this appliance is intended for washing in a dishwasher.



#### Warning:

To prevent the risk of injury by electrical shock, do not submerge the appliance, power cord or power plug in water or any another liquid.

- If necessary, wipe the outer surface of the kettle first with a slightly dampened cloth and then wipe it dry using a clean, dry cloth. In order to prevent water entering the central connector, only wipe the bottom part that is used to seat the kettle on the base using a clean, dry cloth.
- To clean the base stand, use a clean, dry cloth.

#### Cleaning the filters

- The removable filter serves to capture limescale, and thereby prevents it from being poured into a cup together with the water. Regularly clean the filter under running water using a soft nylon brush or submerge it for several hours into a vinegar - water solution (recommended dilution ratio 1:2). After applying the solution, thoroughly rinse the filter under clean running water.

#### Removing limescale deposits

- Limescale deposits inside the kettle may negatively affect its lifetime, so it is important to regularly remove it based on how frequently the kettle is used. During standard use (3 to 5 times per day), we recommend limescale deposits be removed:
  - once per month in areas with hard and very hard water;
  - once every two to three months in areas with soft and medium hard water.
- To remove limescale deposits it is possible to use:
  - 8% white vinegar, generally available in stores. Fill the kettle with a 1:1 water and vinegar solution. Bring the solution to a boil and leave it to

act in the kettle for 2 hours. Then empty the kettle and before further use, boil clean water in it four to five times.

- citric acid. Boil 1 l of water in the kettle, into the boiled water, add 30 g of citric acid and allow the solution to act for about 30 minutes. Then empty the kettle and before further use, boil clean water in it four to five times.

#### STORAGE

- When not using the appliance for an extended period of time, disconnect the plug of the power cord from the power socket, completely empty out the contents of the kettle and allow the appliance to cool down.
- Clean out the appliance according to the instructions in chapter „Cleaning and maintenance“.
- Place the thoroughly cleaned and completely dry appliance in a clean, dry place out of the reach of children and animals. Do not expose the appliance to extreme temperatures.

#### TECHNICAL SPECIFICATIONS

Rated voltage range.....	220–240 V
Rated frequency.....	50–60 Hz
Rated power input.....	1850–2200 W
Maximum capacity.....	1.7 l

We reserve the right to change text and technical specifications.

Due to the continuous development, the images in this user's manual may differ from the actual appliance. We reserve the right to such a change.

#### INSTRUCTIONS AND INFORMATION REGARDING THE DISPOSAL OF USED PACKAGING MATERIALS

Dispose of used packaging material at a site designated for waste in your municipality.

#### DISPOSAL OF USED ELECTRICAL AND ELECTRONIC EQUIPMENT



This symbol on products or original documents means that used electric or electronic products must not be added to ordinary municipal waste. For proper disposal, renewal and recycling, hand these appliances over to determined collection points. Alternatively, in some European Union states or other European countries you may return your products to the local retailer when buying an equivalent new product. Correct disposal of this product helps save valuable natural resources and prevents potential negative effects on the environment and human health, which could result from improper waste disposal. Ask your local authorities or collection facility for more details. In accordance with national regulations penalties may be imposed for the incorrect disposal of this type of waste.

#### For business entities in European Union states

If you want to dispose of electrical or electronic equipment, ask your retailer or supplier for the necessary information.

#### Disposal in other countries outside the European Union.

This symbol is valid in the European Union. If you wish to dispose of this product, request the necessary information about the correct disposal method from the local council or from your retailer.



This product meets all the basic requirements of EU directives related to it.

