

SENCOR®

SES 800BK



FULLY AUTOMATIC ESPRESSO/ CAPPUCCINO MACHINE

Translation of the original manual



SENCOR®

SES 800BK



A

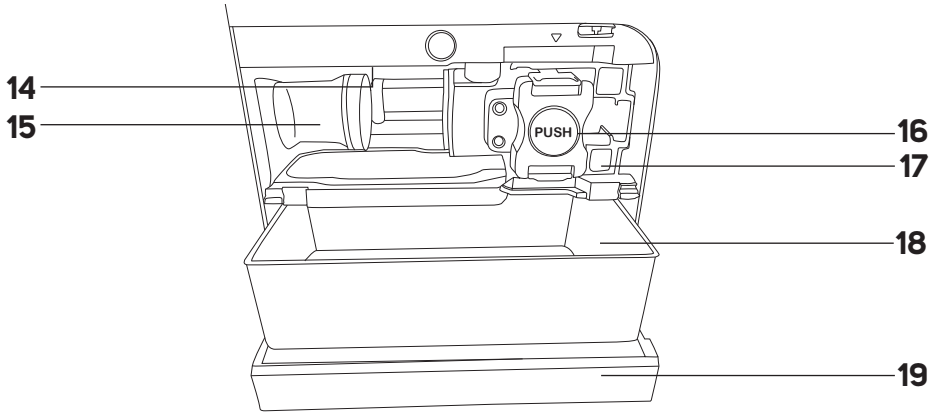
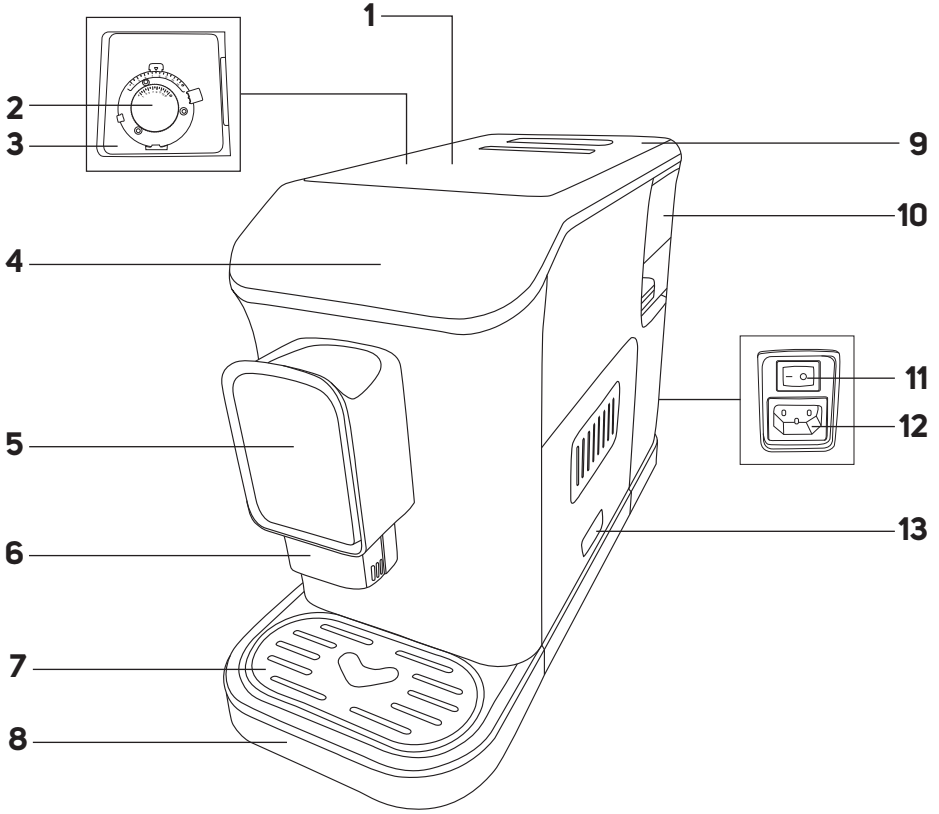

A

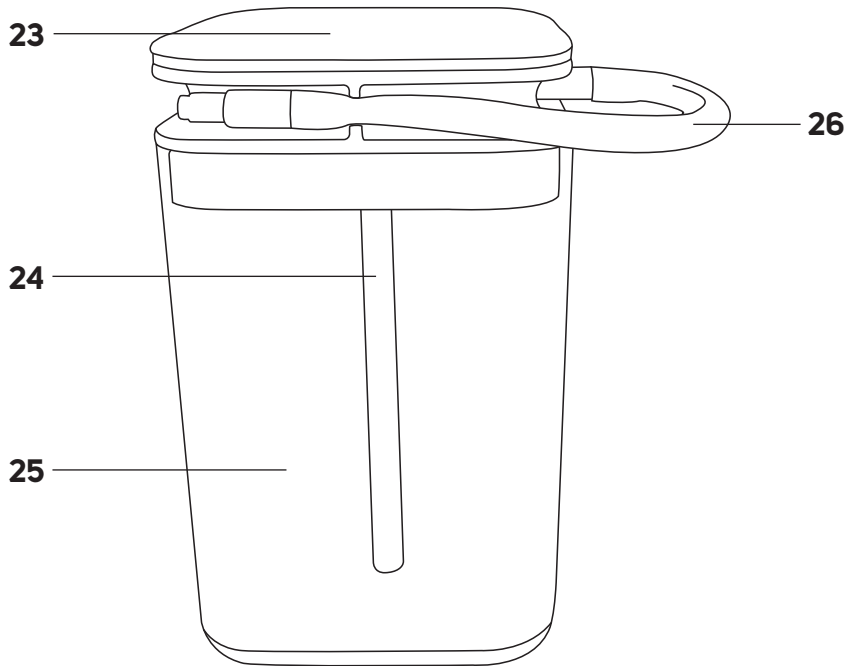
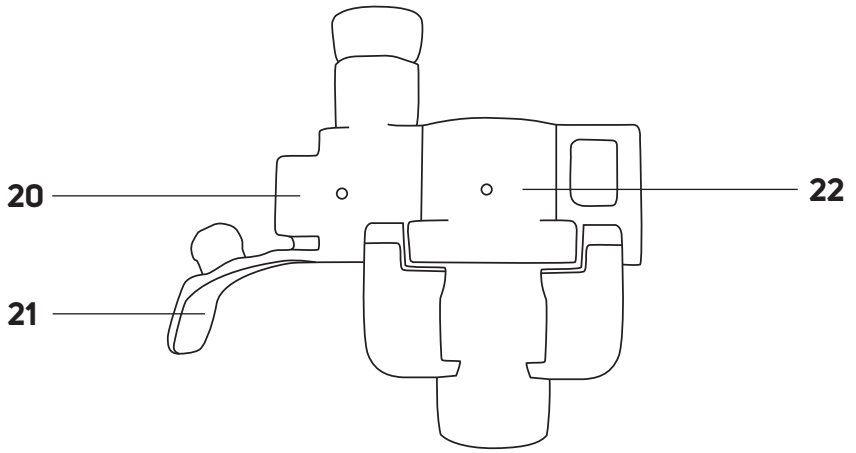

B

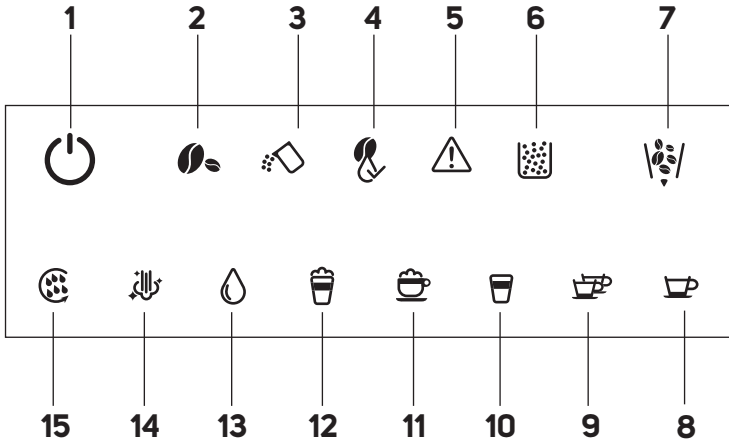

C1

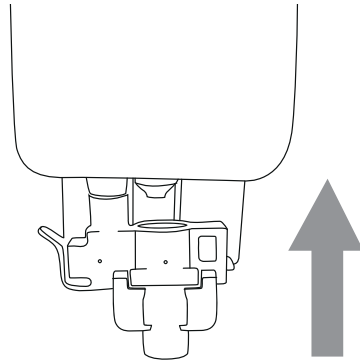

C2

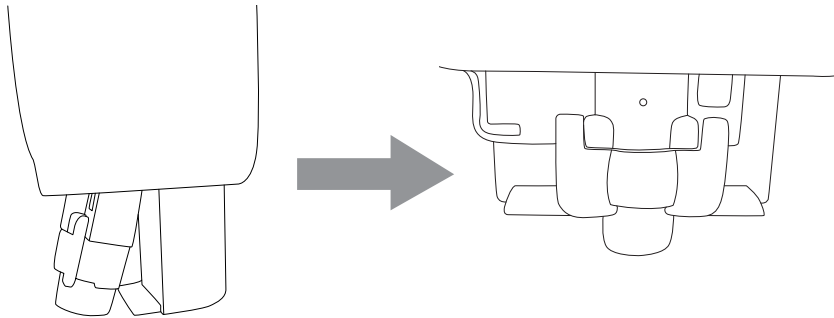

D1

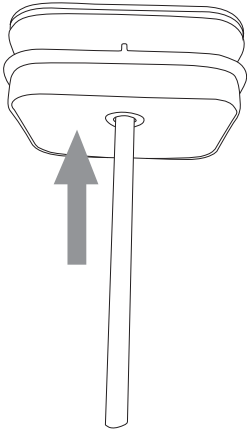

D2

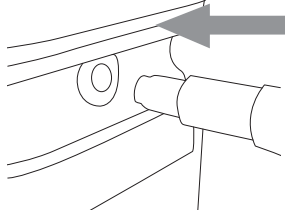

D3

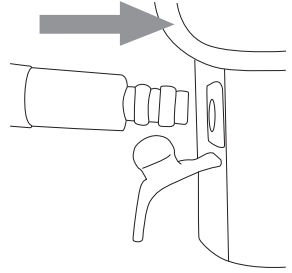

E

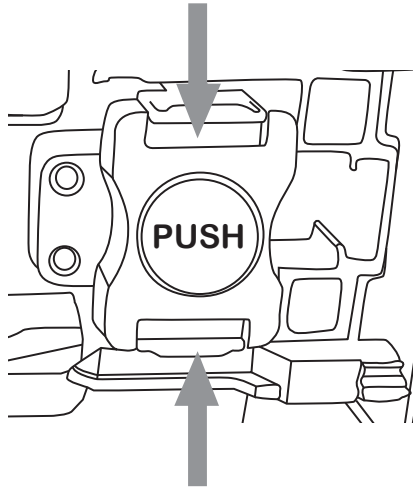

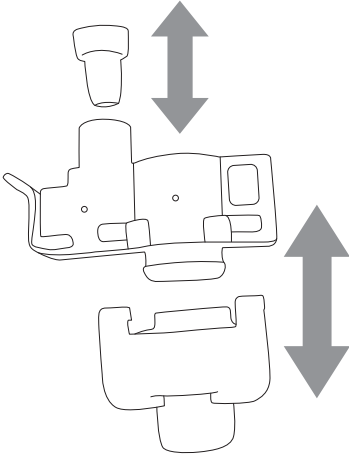
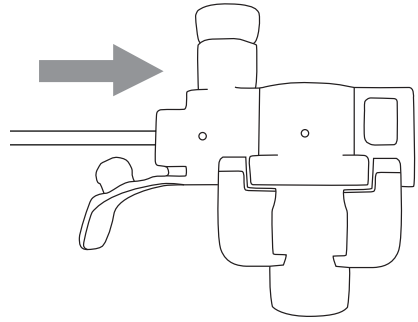
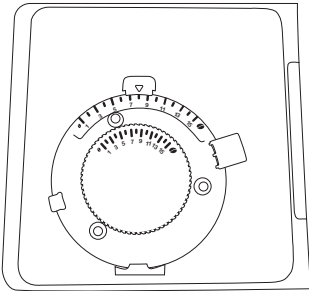
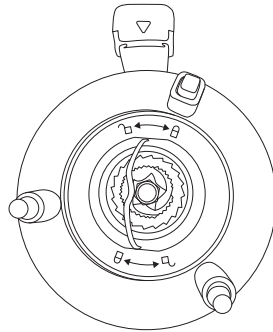
F1**F2****G1****G2**

EN Fully Automatic Espresso/Cappuccino Machine

Important Safety Instructions

READ CAREFULLY AND STORE FOR FUTURE USE.

- This appliance is not to be used by children. Keep this appliance and its power cord out of the reach of children.
- The appliance may be used by persons with reduced physical, sensory or mental abilities or lack of experience and knowledge, provided they are supervised or have been instructed in the safe use of the appliance and understand the potential hazards.
- Children must not play with the appliance.
- Cleaning and maintenance performed by the user must not be performed by children.
- If the power cord is damaged, have it replaced in a professional service centre in order to prevent a dangerous situation. It is forbidden to use the appliance with the power cord damaged.
- Always clean the parts of the appliance that come into contact with food with clean warm water and a little neutral dishwashing liquid, rinse them with clean water and wipe dry.



WARNING:

Incorrect use may lead to injury.

Always disconnect the appliance from the power supply when leaving it unattended and before assembly, disassembly or cleaning.

This appliance is intended for use in the home.

It is not intended for use in areas such as:

- kitchenettes in shops, offices and other workplaces;
- agriculture;
- by guests in hotels, motels and other residential areas;
- bed and breakfast establishments.



WARNING:

Avoid spilling on the plug.



WARNING:

The outer surface of the appliance heats up during use and may be hot for some time after use. Be very careful.

The appliance must not be placed in a cabinet when in use.



WARNING:

The filling hole must not be opened during use. Do not do submerge the power cord, plug or appliance in water or any other liquid.

Electrical Safety

- Before connecting the appliance to a power outlet, make sure that its nominal voltage indicated on the rating plate matches the electrical voltage of the socket.
- Connect the appliance only to a properly grounded socket. For safety reasons, we don't recommend using adaptor plugs or extension cords.
- Do not place the appliance on windowsills, sink drain trays or unstable surfaces. Always place the appliance on a stable, flat and dry surface.
- Do not place the appliance on an electric or gas stove or near an open flame.
- Never use the appliance in the immediate vicinity of a bath, shower or swimming pool.
- Use the appliance only for the purpose for which it has been designed.
- Use the appliance according to the instructions in this user manual. Otherwise injury, damage to the appliance or dangerous situation might occur.
- Only use the appliance with the original accessories supplied with it.
- During operation, a clear space of at least 15 cm must be left around and above the appliance to ensure sufficient air circulation.
- Do not place any items on the top surface of the appliance.
- Fill the water tank with clean, cold water. Do not pour hot water or other liquids into it or place any objects inside it.
- Before turning on the appliance, make sure that:
 - the drip tray with grid is installed in its place;
 - the water tank is filled with a sufficient amount of water and is properly installed in its position;
 - the bean hopper is filled with fresh coffee beans.

Safety in Use

- The water level must not exceed the maximum mark.
- Take extra care when operating the appliance to avoid scalding with hot water or steam.
- The hot water function may only be used continuously for a maximum of one emptying of the entire water tank.
- When using the appliance, check the water level in the water tank regularly. If the water level falls below the minimum mark, refill the water tank. Before adding water, first turn off the appliance and disconnect it from the power socket.
- Use the built-in coffee grinder only for grinding coffee beans. Do not use it for any other purposes.
- Ensure that no hair or other items enter the grinder area during the grinding process. The coffee bean hopper lid should always be properly closed unless you are refilling coffee beans or adjusting the grinding coarseness.
- The appliance is equipped with a built-in thermal fuse that shuts it off when the pump is idling to prevent damage. If such a situation occurs, unplug the power cord and allow the appliance to cool down for at least 30 minutes. Then you can use it again.
- Do not move the appliance with a coffee cup located on the grid of the drip tray.
- Ensure that the power cord does not come into contact with a hot surface.
- Unplug the appliance from the power socket by pulling the plug, not the power cord. Otherwise, damage to the power cord or the socket may occur.
- Do not submerge the appliance, power cord or plug in water or any other liquid.
- Make sure that the power cord and plug does not come into contact with water or other fluid.
- To avoid the danger of injury by electrical shock, do not repair or modify the appliance yourself. Have all repairs or adjustments performed at an authorised service centre. By tampering with the appliance, you expose yourself to the risk of losing your legal rights regarding faulty performance or warranty for quality.

- Thank you for purchasing our SENCOR product; we hope you will be satisfied with it.
- Before using this appliance, please familiarise yourself with the user manual, even if you are already familiar with using similar types of appliances. Use the appliance only as described in this user manual. Keep the manual for future reference.
- For the duration of the legal rights regarding faulty performance or warranty for quality, we recommend keeping the original packaging, packaging materials, receipt, and proof of the seller's liability or warranty certificate. When transporting the appliance, we recommend packaging it again in the original box provided by the manufacturer.
- Fully unwind the detachable power cord and connect it to the socket at the back of the appliance.

PREPARING THE COFFEE MACHINE BEFORE USE

Filling the Water Tank

1. Carefully open the lid of the tank. The lid serves as a handle.
2. Remove the water tank from the rear of the appliance.
3. Fill the water tank with clean water up to the maximum mark and insert it back into the appliance. Make sure that the water tank is properly installed in its place.



Note:

The water that you pour into the water tank should ideally be at room temperature (approximately 25°C). Water that is too cold can adversely affect the final taste of the coffee drink.

Warning:

The maximum capacity of the water tank is 1.5 l of water. Do not overfill it. Never fill the water tank with warm or hot water, sparkling water or other liquids such as milk. This could damage the appliance. Never fill the water tank by pouring water into it while it is inserted inside the appliance. There is a risk of spilling the appliance or overfilling the water tank.



Note:

Do not leave water in the water tank for more than one day. For brewing quality fresh coffee, it is necessary to always use fresh water. Otherwise, the taste of the resulting beverage may be adversely affected.

DESCRIPTION OF THE COFFEE MACHINE

A1 Bean hopper lid	A14 Ground coffee dispensing channel cover
A2 Grinding coarseness regulator	A15 Tamper
A3 Bean hopper, capacity 200 g	A16 Brewing unit
A4 Control panel	A17 Brewing unit holder
A5 Coffee dispensing brewing head (height is adjustable)	A18 Coffee grounds container
A6 Coffee outlet cover	A19 Inner tray
A7 Drip tray grid	A20 Inlet opening
A8 Drip tray	A21 Stopper
A9 Water tank lid	A22 Milk frothing system
A10 Water tank, capacity 1.5 l	A23 Milk container lid
A11 Main power switch	A24 Milk frothing tube
A12 Power cord socket	A25 Mild container, volume 750 ml
A13 Service door	A26 Connecting hose

Not shown: Cleaning brush, power cord

DESCRIPTION OF THE CONTROL PANEL

B1 Button : coffee machine power on/off	B9 Button : start brewing espresso (2 cups)
B2 Indicator light : warning for empty bean hopper	B10 Button : start brewing Americano
B3 Indicator light : warning for empty water tank	B11 Button : start brewing cappuccino
B4 Indicator light : warning for cleaning the brewing unit	B12 Button : start brewing latte
B5 Warning indicator light	B13 Button : hot water dispensing
B6 Indicator light : warning for full coffee grounds container	B14 Button : milk frothing
B7 Button : grinder emptying	B15 Button : manual cleaning
B8 Button : start brewing espresso (1 cup)	

BEFORE FIRST USE

- Before first use, remove the appliance and its accessories from the packaging and remove all promotional labels and tags. Check that neither the appliance nor any of its components is damaged.
- Install the appliance on an even, dry and clean surface.
- Remove the water tank, the brewing unit, the milk frothing system and the milk container. Wash them with clean water and a small amount of neutral kitchen detergent. Then rinse them properly with clean water, dry them and put them back in place.
- Secure the drip tray properly to the appliance.
- Wipe the outer surface of the appliance with a slightly damp cloth and then wipe dry properly.

Filling the Bean Hopper

1. Remove the bean hopper lid.
2. Pour roasted coffee beans into the bean hopper and close the lid. Do not leave the lid of the bean hopper open, otherwise the coffee beans will lose their aroma more quickly.



Warning:

The maximum capacity of the hopper is 200 g of coffee beans. Do not overfill it. Never fill the bean hopper with ground or instant coffee, caramelised or otherwise specially treated coffee beans, cocoa beans or other items that may cause damage to the appliance.

Grinding Coarseness Regulator

Use the grinding coarseness regulator to adjust the appropriate coarseness of the ground coffee. Only adjust the grinding coarseness when the grinder is running. The new coarseness will be reflected on the second or third coffee preparation since the grinding coarseness was changed.

1. You can adjust the coarseness of the grinding in 15 levels by using the grinding coarseness regulator, which is located inside the bean hopper. For first use, we recommend setting the grinding coarseness to 8 and then adjusting as needed.
2. Turn the regulator clockwise to set a coarser grind, turn counterclockwise to set a finer grind. Always adjust by one level. Try it out and then readjust as needed.
3. Only adjust the grinding coarseness when the grinder is running. Otherwise, damage to the appliance could occur.

- If the brewed coffee flows out very slowly, it means that the beans are ground too finely and a coarser grind should be set. On the other hand, if the brewed coffee flows out too fast, it means that the grains are ground too coarsely and a finer grind should be set.

Milk Frothing System

If you are planning to prepare latte, cappuccino, or need to froth milk, it is necessary to attach the milk frothing system. Follow these steps:

- Carefully remove the coffee outlet cover by pressing its sides and pulling it away from the outlet.
- Attach the milk frothing system to the coffee outlet from below (Figure C1). Push gently upwards and then secure it onto the pins so that the round shape of the outlet fits into the round cutout (Figure C2).
- Reattach the coffee outlet cover.

Milk Container



If you are planning to make latte, cappuccino, or need to froth milk, assemble the milk container as follows:

- Pour fresh, cold milk into the container. Always fill below the maximum level. The maximum capacity of the milk container is 750 mL.
- Insert the milk tube into the hole on the inner side of the lid (Figure D1).
- Place the milk container on a stable and flat surface at a sufficient distance from the coffee machine.
- Put the lid on the container.
- Insert one end of the connecting hose into the hole in the lid of the milk container (Figure D2).
- Open the plug of the inlet opening in the milk frothing system and insert the other end of the connecting hose into the opening (Figure D3).

Brewing Head Height Adjustment

- The brewing head can be moved up/down according to the height of the cup in which you will be preparing the coffee. First, place the cup under the brewing head and then adjust the height.

Brewing Unit

- Gently press on the bottom part of the service door where the indentation is located. The service door will swing open. Remove it and check if the brewing unit is properly installed in its place. When inserting the brewing unit into the coffee machine, align the arrow on the brewing unit with the arrow above the brewing unit compartment. After checking, reattach the service door.
- If you remove and reinsert the brewing unit and hear a click, it indicates that the brewing unit is properly installed.
- If the warning indicator light  is continuously on, the brewing unit is not installed correctly.
- If the warning indicator light  blinks when you press the beverage preparation button, the service door is not closed properly.

Coffee Grounds Container and Inner Tray

- Gently press on the bottom part of the service door where the indentation is located. The service door will swing open. Remove it and check if the coffee grounds container and the inner tray are properly installed in their place.
- If the warning indicator light  is continuously on, the inner tray or coffee grounds container is not installed correctly.

Drip Tray

- Attach the grid to the drip tray.
- Place the folded drip tray against the lower front wall of the coffee machine and press it slightly into the machine.
- The tray must be securely in place to prevent the cup with hot beverage from tipping over during preparation.
- Water from the outlet flows into the drip tray during each rinsing, self-cleaning, and also coffee brewing, which may cause spills. Therefore, clean and empty the drip tray daily.

USING THE COFFEE MACHINE









- Place the coffee machine on a flat, dry and clean surface at a sufficient distance from the power socket. Ensure there is enough space around it for manipulation, at least 15 cm around the entire coffee machine.
- Make sure that the water tank is refilled with fresh water, the bean hopper has an adequate amount of coffee beans, and that the appliance is properly assembled.
- Plug the power cord connector into the socket in the coffee machine and connect the power cord plug to the power socket.



Note:

(When refilling water and coffee beans, always follow the instructions provided in chapter "Filling the Water Tank" and "Filling the Bean Hopper".

Turning on the Coffee Machine, Rinsing and Preheating

- Switch the main power switch at the back of the machine to the "I" position (on). You will hear a sound alert and the control panel will briefly light up. Once it goes off, the coffee machine automatically switches to the standby mode.
- Place a cup or bowl under the coffee outlet.
- Press the button  to turn the appliance on. The button  will start blinking and the button  will light up. The coffee machine starts heating up, and the preparation process begins, during which water is pumped into the internal circuit, the grinder is checked, and the coffee outlet is rinsed, with a small amount of water flowing into the cup. During this time, the grinder and pump will briefly operate. This is a normal occurrence.
- At the same time, the steam delivery system will warm up and, during this time, the buttons , , ,  and  will slowly blink. The coffee machine cannot be operated during this time.
- Once the control buttons light up, the coffee machine is ready to use.



Note:

The coffee machine will automatically rinse if it has been in standby mode for more than 4 hours and always after turning it on with the main power switch.

Turning off the Coffee Machine





- When you have finished using the coffee machine, press the button  to turn it off. The coffee machine will switch to the standby mode.
- To completely turn it off, switch the main power switch to the "O" position (off) and unplug the power cord from the power socket.



Note:

The coffee machine is equipped with an automatic standby mode feature. This occurs after 28 minutes of inactivity. This is a normal occurrence.

Preparing Espresso (1 and 2 cups) and Americano

- Place a cup, mug or glass under the brewing head. Adjust the height of the brewing head by moving it up or down depending on the size of your cup, mug or glass. If the cup or glass is too tall, you may remove the drip tray. After removing the cup or glass, return the drip tray to its place.
- Press the button  (for preparing 1 cup of espresso),  (for preparing 2 cups of espresso) or the button  (for preparing Americano). The selected button will light up, the other buttons will turn off except for the button .
- The coffee machine will automatically start the grinding, dosing, tamping and dispensing process.
- Once the coffee dispensing process is complete, you will hear a sound alert, the button  will briefly blink, indicating that the coffee machine is heating up to operating temperature. Once the control panel lights up, the coffee machine is ready to make another coffee.
- Preparing 2 cups of espresso involves two consecutive preparations of 1 cup of espresso. Do not remove the cup from under the brewing head until the preparation of the second cup is complete.

- Preparing Americano coffee consists of preparing 1 cup of espresso and adding hot water. Do not remove the cup from under the brewing head until the hot water dispensing is finished.
- You can cancel the preparation of espresso or Americano coffee by pressing the corresponding button.



Note:

During the coffee preparation process, you may hear the sound of the grinder and pump, and after preparation, the sound of used ground coffee being expelled into the coffee grounds container. These are normal sounds.



Note:

At the beginning of the coffee dispensing process, coffee may drip slowly (2 to 3 seconds after brewing), and then the full coffee dispensing will start. After the dispensing is complete, the coffee may drip from the outlet for about 6 to 8 seconds. This is a normal occurrence.



Preparing Latte/Cappuccino

1. Install the milk frothing system to the coffee outlet following the instructions in the **"Milk Frothing System"** section and assemble the milk container according to the instruction in the **"Milk Container"** section.
2. Make sure that the connecting tube is correctly inserted in the container lid and in the milk frothing system.



Note:

To achieve rich and creamy froth, we recommend using properly chilled milk (around 5°C) with a minimum fat content of 3%.

3. Place a cup, mug or glass under the brewing head. Adjust the height of the brewing head by moving it up or down depending on the size of your cup, mug or glass. If the cup or glass is too tall, you may remove the drip tray. After removing the cup or glass, return the drip tray to its place.
 4. Press the button  (to make a cappuccino) or  (to make a latte). The pressed button will light up.
 5. The coffee machine will automatically start the preparation process for latte or cappuccino.
 6. Once the preparation is complete, you will hear a sound alert, the button  will briefly blink, indicating that the machine is heating up to operating temperature. Once the control panel lights up, the coffee machine is ready to make another coffee.
 7. Disconnect the connecting tube and store any remaining milk in the container in the refrigerator.
- You can cancel the preparation of cappuccino or latte by pressing the corresponding button.
 - When the preparation is complete, it is necessary to clean the milk frothing system, the connecting tube, and the milk container if it is empty. Follow the instructions in the **"Cleaning and Maintenance"** section.



Note:

After the preparation of cappuccino or latte, the overheating protection mechanism is activated. During this time, the indicator light  will slowly blink. This is a normal occurrence. If you need to dispense hot water, allow the machine to cool down for 3 to 5 minutes.



Milk Frothing

1. Install the milk frothing system to the coffee outlet following the instructions in the **"Milk Frothing System"** section and assemble the milk container according to the instruction in the **"Milk Container"** section.
2. Make sure that the connecting tube is correctly inserted in the container lid and in the milk frothing system.



Note:

To achieve rich and creamy froth, we recommend using properly chilled milk (around 5°C) with a minimum fat content of 3%.

3. Place a cup, mug or glass under the brewing head. Adjust the height of the brewing head by moving it up or down depending on the size of your cup, mug or glass. If the cup or glass is too tall, you may remove the drip tray. After removing the cup or glass, return the drip tray to its place.
4. Press the button . The pressed button will light up.
5. The dispensing of hot milk and milk froth will start. Approximately 160 ml of hot milk and milk froth will flow into the cup.
6. Once the preparation is complete, you will hear a sound alert, and the button  will blink briefly, indicating that the coffee machine is heating up to operating temperature. Once the control panel lights up, the coffee machine is ready to make another coffee.
7. Disconnect the connecting tube and store any remaining milk in the container in the refrigerator.



- You can cancel milk frothing by pressing the button .
- When the preparation is complete, it is necessary to clean the milk frothing system, the connecting tube, and the milk container if it is empty. Follow the instructions in the **"Cleaning and Maintenance"** section.



Note:

After the preparation of cappuccino or latte, the overheating protection mechanism is activated. During this time, the indicator light  will slowly blink. This is a normal occurrence. If you need to dispense hot water, allow the machine to cool down for 3 to 5 minutes.

Dispensing Hot Water

1. Place a cup, mug or glass under the brewing head. Adjust the height of the brewing head by moving it up or down depending on the size of your cup, mug or glass. If the cup or glass is too tall, you may remove the drip tray. After removing the cup or glass, return the drip tray to its place.
2. Press the button  and the coffee machine will start dispensing hot water. Approximately 120 ml of hot water will flow into the cup.
3. Hot water dispensing will stop automatically, you will hear a sound alert, the button  will briefly blink, indicating that the machine is heating up to operating temperature. Once the control panel lights up, the coffee machine is ready to make another coffee.

You can cancel hot water dispensing by pressing the button .





Warning:

The water is very hot and improper handling can cause serious burns. Be careful when handling hot contents.

USER SETTINGS

Setting the Coffee Volume

The coffee machine allows you to adjust the volume of dispensed coffee according to your preferences. The settings you make will be saved to the memory of the coffee machine.

1. Place a cup, mug or glass under the brewing head.
2. Press the beverage button  or  for the drink you want to prepare. The pressed button will light up.
3. Once the machine starts dispensing coffee, press and hold the selected beverage button until the beep sounds and the selected beverage button blinks.
4. Keep the button pressed until the desired volume of coffee is dispensed into the cup. Release the button and the volume of dispensed coffee will be saved to the appliance memory.

The range of coffee volume is as follows:

- 1 cup of espresso: 30–100 ml
- 2 cups of espresso: 2x (30–100 ml)
- Americano: 110–180 ml

Setting the Milk Dispensing Time

The coffee machine allows you to adjust the volume of dispensed milk according to your preferences. The settings you make will be saved to the memory of the coffee machine.



1. Place a cup, mug or glass under the brewing head.
2. Press the beverage button (☕ or 🍷) for the drink you want to prepare. The pressed button will light up.
3. Once the machine starts dispensing milk, press and hold the selected beverage button until the beep sounds and the selected beverage button blinks.
4. Keep the button of the selected beverage pressed until the desired amount of milk is dispensed into the cup. Release the button and the volume of dispensed milk will be saved to the appliance memory.

The range of milk volume is as follows:

- Cappuccino: 30–100 ml (coffee) + 10–40 seconds (milk)
- Latte: 30–100 ml (coffee) + 10–40 seconds (milk)



GRINDER EMPTYING

This function is used to empty the grinder and remove any coffee beans inside it if you won't be using the coffee machine for an extended period to prevent them from deteriorating.

1. Empty the bean hopper.
2. Press the button  to start the grinder emptying function. The button  will light up.
3. The grinder will stop after about 15 seconds. If the grinder is still full, run the function again.
4. Empty the coffee grounds container.

You can cancel the emptying function of the grinder by pressing the button .

STANDBY MODE



- Press the button  and the coffee machine will switch to standby mode. In this mode, the control panel will be off and no buttons will function.
- Press the button  to cancel the standby mode and turn on the coffee machine.



Note:

The coffee machine is equipped with an automatic standby mode feature. This occurs after 28 minutes of inactivity. This is a normal occurrence.

FACTORY RESET

- If you need to restore the factory settings and erase all your customized settings, perform a factory reset.
- Press the buttons  and  simultaneously for 2 seconds. You will hear a sound alert indicating the factory reset has been completed.

CLEANING AND MAINTENANCE

Before cleaning, turn off the coffee machine and switch the main power switch to the "0" position. Unplug the power cord from the power socket and let the appliance cool down.



Warning:

Do not use abrasive cleaning agents, solvents, or any substances to clean any parts of the appliance that could damage the surface of the appliance. None of the components of this appliance are dishwasher safe.



Warning:



To prevent the risk of electric shock, do not submerge the appliance, plug or power cord in water or any other liquid.

DAILY CLEANING AND MAINTENANCE

- Regular cleaning and maintenance are crucial for the proper functioning and longevity of the appliance.
- Before cleaning, turn off the appliance, unplug it and allow it to cool down.

Manual Rinsing

We recommend cleaning the coffee outlet after each use. This is also recommended when the appliance has not been used for an extended period of time.

1. Press the button  to initiate the manual rinsing process. Several rinses and hot water dispensing will occur. Pour out the water.
2. The manual rinsing process will automatically stop, you will hear a sound alert and the button  will briefly blink, indicating that the machine is heating up to operating temperature. Once the control panel lights up, the coffee machine is ready for the coffee preparation.
3. You can cancel the manual rinsing process by pressing the button .

Drip Tray

The drip tray should be emptied daily.

- Carefully pull out the drip tray from the coffee machine. Remove the grid. Empty its contents over the sink.
- Clean the drip tray and grid with warm water and a little dishwashing detergent. Rinse and wipe dry.
- Be careful when handling the **A11** tray to avoid scalding. It may contain hot water.
- Place the grid back onto the drip tray and insert into the coffee machine.

Coffee Grounds Container and Inner Tray

Empty the coffee grounds container whenever the warning indicator light  comes on. The coffee grounds container has a capacity of 8 coffee servings. When emptying the container, ensure the coffee machine is turned on to reset the counter.

- Gently press on the bottom part of the service door where the indentation is located. The service door will swing open. Remove it and carefully slide out the inner tray with the coffee grounds container.
- Empty the coffee grounds container into the municipal waste or compost.
- Empty the contents of the drip tray over the sink.
- Clean the inner tray and coffee grounds container with warm water and a little dishwashing detergent. Rinse and wipe dry.
- Insert the coffee grounds container into the inner tray and slide the inner tray back into the coffee machine. Reattach the service door.



Note:

Empty the coffee grounds container and clean the brewing unit whenever the coffee machine is turned on. If you empty the container or clean the brewing unit while the coffee machine is turned off, the counter will not reset.

Brewing Unit

We recommend cleaning the brewing unit at the same time as emptying the coffee grounds container.

- Gently press on the bottom part of the service door where the indentation is located. The service door will swing open. Remove it.
- Press both latches on the brewing unit and remove it from the coffee machine (Figure E).
- Wash it under running water and then dry it properly.

- Insert the brewing unit back into the coffee machine, aligning the arrow on the brewing unit with the arrow above the brewing unit compartment. A click indicates that the brewing unit is correctly installed.
- Reattach the service door.



Note:

If the warning indicator light  is continuously on, the brewing unit is not installed correctly.



If the warning indicator light  blinks when you press the beverage preparation button, the service door is not closed properly.

Water Tank

Remove the water tank, rinse it with clean water, dry it and put it back in its place.

Milk Frothing System

To prevent milk from settling in the system and creating unwanted odours, it is important to clean it after each use.

1. Place a cup or glass under the brewing head.
2. Fill the milk container with clean water.
3. Install the milk frothing system to the coffee outlet according to the instructions in the **“Milk Frothing System”** section.
4. Press the button  to start the manual rinsing process of the coffee machine. Several rinses and hot water dispensing will occur. Pour out the water.
5. The manual rinsing process will automatically stop, and you will hear a sound alert, the button  will briefly blink, indicating that the coffee machine is heating up to operating temperature. Once the control panel lights up, the coffee machine is ready to make another coffee.
6. You can cancel the manual rinsing process by pressing the button .
7. Allow the coffee machine cool down for a while so that you can remove the milk frothing system and clean it manually.
8. Carefully remove the coffee outlet cover by pressing its sides and pulling it away from the outlet.
9. Remove the milk frothing system, disassemble it (Figure F1), rinsing all parts under running water.
10. It is important to clean the milk inlet opening with a thin object (e.g. a needle) (Figure F2).
11. Thoroughly dry all parts and then reassemble them.

Milk Container, Milk Tube and Connecting Hose



1. Disconnect the connecting hose from the container lid.
2. Remove the lid from the milk container and pour out the remaining contents of the milk container.
3. Remove the milk tube from the underside of the lid.
4. Wash the milk container, lid, milk tube and connecting hose in warm water with a small amount of neutral dishwashing detergent. Rinse under clean water and dry properly.
5. If necessary, you can use a needle to remove debris from the holes at the ends of the connecting hose and in the cap where the connecting hose is inserted.
6. Before assembling, make sure that both ends of the connecting hose are clean and dry.

REGULAR MAINTENANCE





Perform regular maintenance on the coffee machine at least once a week.

Coffee Bean Hopper and Grinder

1. Empty the coffee beans from the hopper and store them in an airtight container.
2. Start the emptying function of the grinder
3. Turn the grinding coarseness regulator counterclockwise until the tabs on the regulator are aligned with the notches on the grinder (Figure G1).
4. Lift the regulator upward and remove it from the grinder.
5. Lift the handle of the upper grinding stone and turn it counterclockwise in the direction of the  symbol.





6. Remove the upper grinding stone and clean it using a cleaning brush.
7. Clean the lower grinding stone and chamber using a cleaning brush.
8. Insert the upper grinding stone into the grinding chamber, aligning the  symbol with the arrow on the grinder outlet (Figure G2).
9. Rotate the handle of the upper grinding stone clockwise in the direction of the  symbol. Lower the handle.
10. Attach the grinding coarseness regulator, ensuring that the tabs on the regulator fit onto the notches on the grinder (Figure G1), and rotate the regulator clockwise.

Brewing Unit Holder

1. While the coffee machine is powered on, simultaneously press the buttons  and  until they start blinking.
2. The brewing unit holder will enter the brewing coffee position.
3. Open the service door and wipe the holder and the area underneath it.
4. After cleaning, close the service door and simultaneously press the buttons  and . The holder will retract back to its original position.

Ground Coffee Dispensing Channel







The ground coffee dispensing channel can be cleaned using the following steps.

1. Simultaneously press the buttons  and  until they start blinking.
2. The cover of the ground coffee dispensing channel, located above the tamper, will open.
3. Open the service door and use a cleaning brush to remove any dirt from the channel. The dirt will fall into the coffee grounds container. Clean the container as well.
4. When the ground coffee dispensing channel is clean, close the service door and simultaneously press the buttons  and . The cover of the ground coffee channel will close.

Outer Surface of the Coffee Machine

To clean the outer surface of the appliance, use a clean, slightly damp cloth. Afterwards, wipe it dry thoroughly.

DESCALING















- Mineral deposits from water can accumulate in the internal circuitry of the coffee machine with regular use. It is a natural process. Therefore, regular descaling is necessary. Mineral deposits can adversely affect the taste of the coffee being brewed.
 - The coffee machine is equipped with a built-in counter that keeps track of the number of prepared coffees, and once it reaches 500, the descaling process should be performed. In such a case, the buttons  and  will start blinking.
1. Fill the water tank with a solution of water and descaling agent. Use a descaling agent suitable for espresso-type machines and follow the instructions given in the descaling agent’s accompanying documentation.
 2. Place a bowl under the brewing head.
 3. Press and hold the buttons  and  simultaneously. The coffee machine will enter the descaling mode.
 4. The descaling process takes about 10 minutes. The control buttons will slowly blink from left to right. Allow the coffee machine to complete the descaling process.
 5. Once the descaling process is complete, the buttons  and  will turn off.
 6. Remove the water tank and refill it with clean, cold water. Place it back into the coffee machine and activate the manual rinsing process.









Storage

- If the appliance will not be used for an extended period, unplug it from the power socket, let it cool down, and clean it following the instructions provided above.
- Before storing, ensure that the appliance and all accessories are thoroughly clean and dry.

- Store the appliance in a dry, clean, and well-ventilated place away from extreme temperatures and out of the reach of children or pets.

TROUBLESHOOTING

Problem	Cause	Solution
The indicator light  is blinking.	Insufficient water in the tank.	Refill the water tank.
The warning indicator light  is blinking.	Incorrectly inserted service door.	Properly insert the service door.
The warning indicator light  is on.	Improperly inserted brewing unit, coffee grounds container, or inner tray.	Insert the brewing unit, coffee grounds container and inner tray correctly.
The indicator light  is on.	Insufficient coffee beans in the hopper.	Add coffee beans to the hopper.
The indicator light  is on.	Coffee grounds container is full.	Empty the coffee grounds container and inner tray.
The indicator light  is on.	Brewing unit needs to be cleaned.	Remove the brewing unit and clean it. Then, reinsert it.
The button  is blinking.	Water heater overheating protection mechanism is activated.	Turn off the coffee machine and disconnect it from the power source. Let it cool down for 3 to 5 minutes and then you can use it again.
The button  and warning indicator light  are blinking simultaneously.	Grinder motor malfunction.	Turn off the coffee machine, wait for a while, then turn it on again.
The indicator lights  and  are blinking simultaneously.	The coffee machine has ground coffee for 16 cycles with each grinding time being less than 5 minutes.	Turn off the coffee machine and disconnect it from the power source. Let it cool down for 5 minutes and then you can use it again.
The button  and warning indicator light  are blinking simultaneously.	The flow meter has no signal and the water dispensing is abnormal.	Add water to the water tank.
The button  and warning indicator light  are blinking simultaneously.	Hall sensor has no signal and brewing unit is not functioning properly.	Turn off the coffee machine, wait for a while, then turn it on again.
Weak milk froth.	The ground coffee is too coarse.	Turn the coarseness regulator clockwise to adjust the grinder setting.
	You are using unsuitable roasted coffee beans.	Use roasted coffee beans specially for espresso machines.
Slow or dripping coffee flow.	The ground coffee is too fine.	Turn the coarseness regulator counterclockwise and adjust the grinder setting.
Coffee machine does not dispense coffee.	Coffee outlet is clogged.	Clean the coffee outlet, for example, using a thin object.

Coffee machine cannot be turned on.	The plug is not inserted correctly into the power socket.	Check the plug connection in the power socket.
	The power cord is not inserted correctly in the socket at the back of the coffee machine.	Check the power cord connection.
	Main power switch is in the "0" position.	Switch the main power switch to the "I" position.
	You didn't press the button  .	Press the button  to turn the appliance on.
The brewing unit cannot be removed.	The brewing unit is blocked.	Contact an authorised service centre.
Indicator lights  and  are on.	Coffee grounds container needs to be emptied and brewing unit needs to be cleaned.	Empty the coffee grounds container and clean the brewing unit. Wait about 3 seconds before reinstalling.
The indicator light  is on, but the coffee grounds container is empty.	The internal counter has not been reset after emptying the tank or cleaning the brewing unit.	Always wait for about 3 seconds for the counter to reset after emptying the coffee grounds container or cleaning the brewing unit. Empty the coffee grounds container and clean the brewing unit whenever the machine is turned on. If you empty the container or clean the brewing unit when the machine is turned off, the counter will not reset.
The grinder grinds but does not dispense ground coffee.	Deeply roasted beans may have oil on their surface. If the coffee beans are wet or have too much oil on their surface, the ground coffee dispensing channel will be blocked.	Press and hold the buttons  and  simultaneously for 2 seconds, and they will start blinking. Open the service door and remove the ground coffee from the ground coffee dispensing channel using a brush. Close the service door once the ground coffee starts to fall freely. Press and briefly hold the buttons  and  , and they will turn off.
The coffee machine is too noisy.	It is normal for the coffee machine to make noise during operation.	If the coffee machine starts to make a different kind of noise, lubricate the brewing unit.



Note:

If the problem is not listed in the table or if the problem persists, turn off the coffee machine, disconnect it from the power source, and contact an authorised service centre.

TECHNICAL SPECIFICATIONS

Rated voltage range.....220–240 V-
Rated frequency.....50 Hz
Rated power input.....1350 W
Noise level.....70 dB(A)

The declared noise emission level of the appliance is 70 dB(A), which represents a level A of acoustic power with respect to a reference acoustic power of 1 pW.

We reserve the right to change the text and technical specifications.
.....

INSTRUCTIONS AND INFORMATION ON DISPOSAL OF USED PACKAGING MATERIAL

Dispose of the packaging material at the designated waste disposal area determined by your local municipality.

DISPOSAL OF USED ELECTRICAL AND ELECTRONIC EQUIPMENT



This symbol on the products or accompanying documents indicates that used electrical and electronic products should not be disposed of with regular municipal waste. For proper disposal, recovery and recycling, take these products to designated collection points. Alternatively, in some European Union states or other European countries, you can return your products to the local retailer when purchasing an equivalent new product. By correctly disposing of this product, you help conserve valuable natural resources and contribute to the prevention of potential negative impacts on the environment and human health that could result from improper waste disposal. For more details, contact your local authority or nearest collection facility. Failure to properly dispose of this type of waste may result in fines in accordance with national regulations.

For Businesses in European Union Countries

To dispose of electrical and electronic equipment, obtain the necessary information from your retailer or supplier.

Disposal in Countries outside the European Union

This symbol is valid within the European Union. To dispose of this product, obtain the necessary information on the correct disposal method from local authorities or your retailer.



This product complies with all the essential requirements of the EU directives that apply to it.

