

SENCOR®

SBP 1150WH
Model: AOJ-30G



DIGITAL BLOOD PRESSURE MONITOR
Translation of the original manual



SENCOR®

SBP 1150WH

Model: AOJ-30G



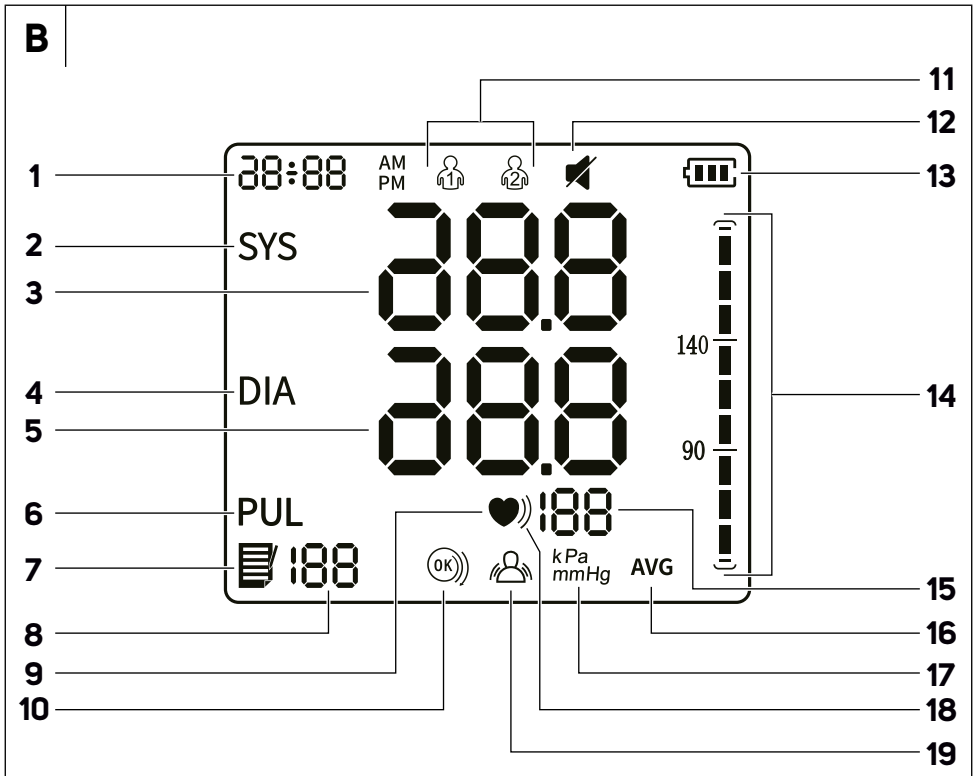
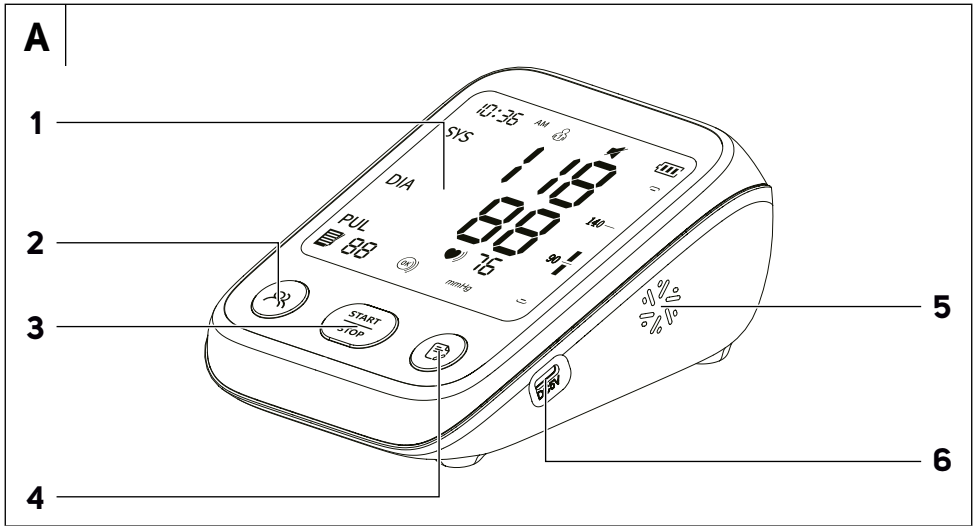

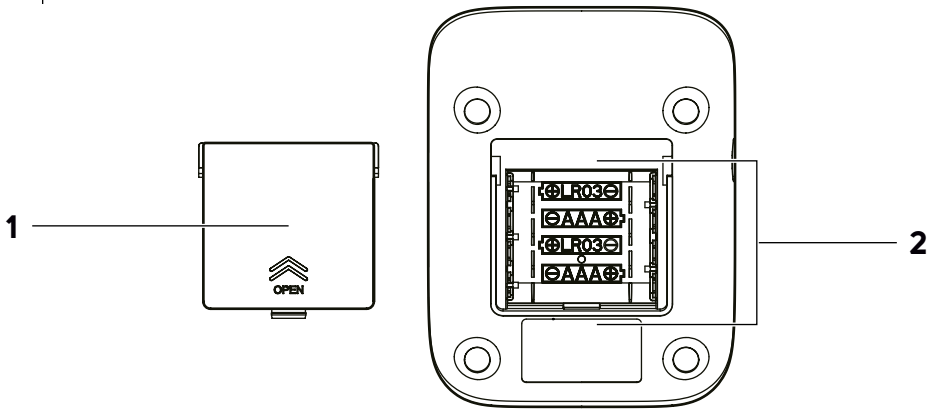
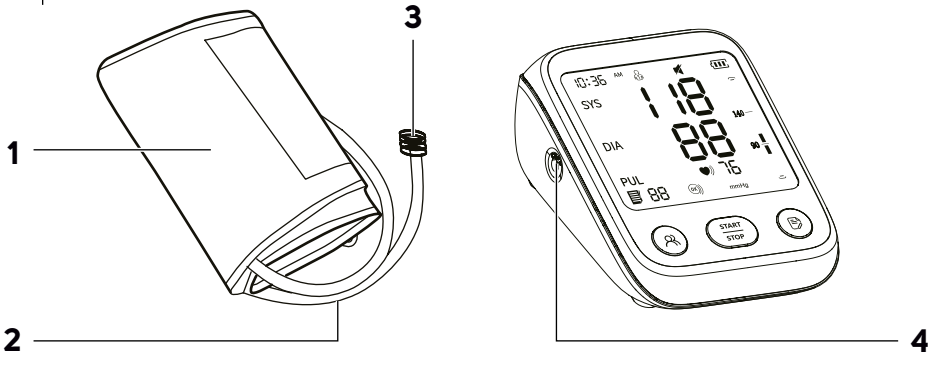
C**D**

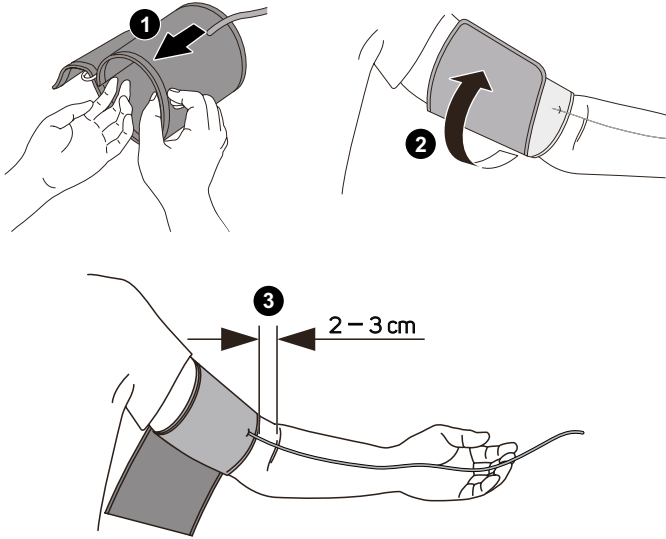
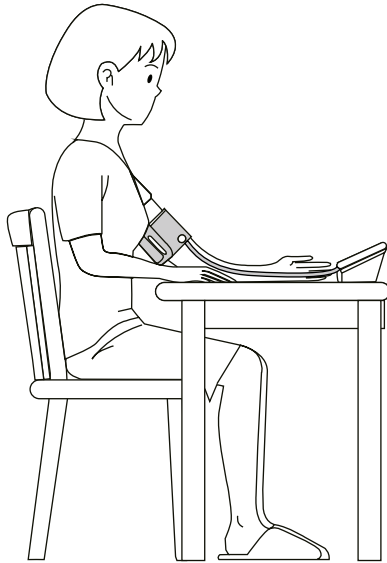
E**F**

EN Digital blood pressure monitor

Important safety instructions

READ CAREFULLY AND STORE FOR FUTURE USE.

GENERAL WARNINGS

- Prior to using this device, please read the user's manual thoroughly, even in cases, when one has already familiarised themselves with previous use of similar types of devices. Use the device only as described in this manual. Keep this user's manual for future use.



Attention:

Not following the instructions contained in this user's manual may lead to faulty operation of the device or its damage.

- This device is intended only for adults in a domestic environment. The device is not intended for commercial use.
- This device and cuff is suitable for use in the domestic conditions of the patient. The patient should not use the device if they suffer from an allergy to polyester, nylon or plastic.
- Do not use this device for infants, toddlers, children or persons who are not able to express themselves. This device is not suitable for pregnant women, patients with implanted electronic devices, patients with pre-eclampsia, patients with heart arrhythmia, atrial fibrillation, peripheral artery disease, and furthermore by patients that are undergoing intravascular treatment or have an arteriovenous switch or patients after a mastectomy. Always consult the use of the device before using it with your medical doctor if you suffer from any of the aforementioned illnesses or their symptoms.
- The device is not suitable for measuring blood pressure of children. Please consult with your medical doctor prior to using it on older children.
- The device is not intended to be used on patients under transport outside of medical facilities.
- The device is intended for non-invasive blood pressure measurement or monitoring. It is not intended for use on limbs other than arms and for other functions than the measurement of blood pressure.
- Do not take medication based on the data from this device. If you wish to know specific information regarding your blood pressure, please contact your doctor. The patient must not perform self-diagnosis nor self-treatment based on the measured results. Please adhere to the instructions of your doctor or healthcare provider.
- Never perform diagnostics or treatment on your own based on the measured values from this device. Always consult with your doctor. Do not confuse self-monitoring with self-diagnosis. Do not commence or conclude treatment prescribed by a medical doctor without prior consultation.
- When regularly taking medication, contact your medical doctor to determine the most suitable time for measuring blood pressure. Never change the prescribed treatment and medication schedule without prior consultation with your medical doctor.
- Do not implement any therapeutic measures on the basis of self-measurement. Never adjust the dosage of the medications prescribed by your medical doctor. Consult with your medical doctor in the event of any questions regarding your blood pressure.
- In the event that the device is used on patients suffering from heart arrhythmia, whether arterial or ventricular arrhythmia, or arterial fibrillation, the best result may be recorded with a deviation. Contact your medical doctor with the results.
- This device cannot be used simultaneously with high-frequency surgical equipment.
- This device is not suitable for continuous monitoring of blood pressure during emergency assistance or during an operation. Otherwise there is a risk of loss of feeling in the upper arm of the patient, the upper arm may become swollen or may even turn blue due to a lack of blood.
- This device may only be used for the purposes described in this user's manual. The manufacturer bears no responsibility for damages caused by its incorrect use.
- This device contains fragile parts and it is necessary to handle it with care. Adhere to the instructions for storage and operating conditions as described in this user's manual.
- This device is not an AP-APG category device and is not suitable for use in the vicinity of flammable mixture of anaesthetics and air or flammable mixtures of anaesthetics and oxygen or nitrogen oxide.



Warning:

Do not perform any repairs or maintenance while this device is in operation.

- The patient is also a user of the device.
- The patient may compare values and change batteries under normal conditions, and may carry out maintenance of the device and its accessories only according to the instructions in this user's manual.
- To prevent erroneous measurements, do not expose the device to strong electromagnetic fields that emit an interference signal or to a fast electric transition / burst signal.

- Do not use this device if you are receiving intravenous nutrition or a blood transfusion. Do not use this device in locations where high-frequency (HF) surgical equipment, magnetic resonance imaging (MRI) equipment or computer tomography (CT) scanners are present. This could result in the incorrect function of the device or in incorrect measurements.
- If you have undergone a mastectomy, please consult your medical doctor prior to using this device.
- If you have serious blood circulation problems or blood issues, please consult your medical doctor prior to using this device because the inflation of the cuff may cause bruises.

SAFETY DURING USE

- Only use the supplied cuff or its original replacement. When unauthorised cuffs are used, incorrect values may be measured.
- The device may only be used by persons with an arm circumference corresponding to the specifications of the device.
- Do use the device empty. Incorrect use of the device may negatively affect its accuracy and lifetime.
- Before use, check that the device works safely and is not damaged. Do not use the device if it exhibits any signs of damage. In the event that the device is used when damaged, this could cause serious injuries, inaccurate measurement or a serious hazard.
- Do not expose the device to the effects of the outdoor environment, extreme temperatures, direct sunlight or locate it in the vicinity of an open flame, heating elements and other equipment or appliances that could be potential sources of heat.
- Use and store the device at room temperature.
- Do not use this device in a moving vehicle, e.g. in a car.
- Do not bend the connecting air hose while using the device, otherwise the pressure in the cuff may continue to increase, which may cause blood to stop flowing in the upper arm and may thus result in serious injury to the patient.
- During use, pay special attention in the following circumstances, during which the circulation of blood in the upper arm of the patient may be interrupted, which may result in serious injuries: overly frequent bending of the air hose or several consecutive measurements; positioning of the cuff and its attachment in the location where there is an intravascular input or bandage, or arteriovenous switch present or in the event that the cuff is inflated on the side of the mastectomy location.
- Do not attach the cuff in a location where there is a sign of injury. Otherwise, this poses a risk of serious injury.
- Do not inflate the cuff on an upper arm where another medical monitoring device is already applied because this could result in a temporary loss of function of all the devices.
- Very rarely a situation may arise, where the cuff will inflate after the completion of measurement. In the case of such an event, immediately release the cuff. The pressure exerted on the arm, which acts for too long, could cause bruising.
- Check that the operation of the device has not resulted in worsened blood circulation in the body.
- During measurement, avoid compression or bending of the air hose.
- Excessively frequent or continuous measurement may cause blood circulation disorders or injuries.
- In the event that you notice skin irritation or any type of discomfort during the use of this device, stop using it and consult with your medical doctor.
- The cuff is in contact with the patient's skin during use. The materials from which the cuff is made, have been tested and meet strict directives. The cuff should not cause any potential irritation or undesirable reaction.
- If not feeling well during measurement, for example if you feel pain in your upper arm or another pain, immediately turn off the device, which will immediately release the air from the cuff. Release the cuff and remove it from the arm.
- Wireless communications equipment such as wireless home network equipment, mobile telephones, wireless telephones and their charging bases, transmitters, may affect this device and should be kept at a distance of at least 30 cm from this device.
- Luer type fittings are not used in the construction of the air hose. There exists a possibility that they could be accidentally connected to intravascular circulation systems, which would enable air to be pumped in to blood vessels.
- Use the device in an environment that is described in this user's manual. Otherwise, the operation and lifetime of the device may be negatively affected or shortened.
- If the device has fallen on the ground or a heavier item has fallen on it, under no circumstances continue using it, but rather hand it over to an authorised service centre for inspection. If the device has fallen into water or it has been splashed with a liquid, under no circumstances continue using it, but rather hand it over to an authorised service centre for inspection.

SAFETY DURING MAINTENANCE AND STORAGE

- Perform cleaning and maintenance according to the instructions in this user's manual. Never wash the device or its parts under running water, in the washing machine or in a dishwasher.
- Do not repair the device yourself or make any adjustments to it. Have all repairs or adjustments of the device performed at an authorised service centre. Failure to do so will expose you to the risk of voiding the warranty policy.
- The lifetime of the cuff depends on the number of times it has been cleaned, condition of the skin and storage conditions.
- The device does not require calibration within the scope of two years of reliable operation.
- If you have any problem with the device, e.g. settings, maintenance or use, please contact an authorised service centre. In the event that it does not function, do not repair the device yourself. The device must be serviced, repaired only by a qualified person from an authorised service centre.
- Please contact an authorised service centre in the event of unexpected operation or function.
- Keep the device out of reach of infants, small children and animals to prevent potential inhalation or swallowing of small parts. There is a risk of a serious to fatal situation arising.
- Be careful to prevent chocking since the hose is long.
- In the event that this device has been stored in a room with a temperature of less than 5 °C, take the device, for at least one hour, to a location where the ambient temperature is in the range from 5 °C to 40 °C. Conversely, if the device has been stored at a temperature higher than 40 °C, take the device, for at least 2 hours, to a location where the ambient temperature is in the range from 5 °C to 40 °C.
- When not using the device, store it in a dry well-ventilated place. Protect it against excessive humidity, heat, fibres, dust or direct sunlight. Do not place any heavy items on the device.

ELECTRICAL SAFETY











- Use a standard AAA-type batteries. When replacing the batteries, adhere to the marked polarity. When not using the blood pressure monitor for an extended period of time, remove the batteries out of it.
- In the event that there are visible signs of corrosion on any of the batteries or electrolyte is leaking out, replace it immediately, otherwise the blood pressure monitor may be damaged.
- Dispose of a flat batteries in an appropriate manner.
- If the blood pressure monitor falls into water, under no circumstances continue using it, but rather hand it over to an authorised service centre for inspection.
- At the end of its lifetime, dispose of the device and its parts according to local directives.









CONTRAINDICATIONS

- There are no known contraindications for this device.
-

EXPLANATION OF SYMBOLS

- Understanding warning labels and symbols is fundamental from the standpoint of the safe and correct use of this device. You may come across the following symbols and labels in this user's manual or on the rating label of the device:

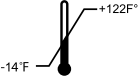
Symbol	Meaning
	Important information, please adhere to it
	Note
	Protection against electric shock (applies to BF type parts)
	Information about handling electrical and electronic devices
	Study and follow the user's manual.
	Keep the device dry
	Low battery voltage
	Do not expose the device to direct sunlight
	This side up
IP21	Protected against foreign objects ≥ 12.5 mm and against vertically dripping water
RoHS	RoHS mark
	CE mark

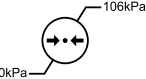
	<p>Manufacturer: Shenzhen AOJ Medical Technology Co., Ltd. Room 301&4F, Block A, Building A, Jingfa Intelligent Manufacturing Park, Xiaweiyuan, Gushu Community, Xixiang Street, Bao'an District, 518126 Shenzhen, CHINA</p>
	<p>Date of manufacture:</p>
	<p>Serial number</p>
	<p>Batch number</p>
	<p>Authorised for the EU: Share Info GmbH Heerdter Lohweg 83, 40549 Düsseldorf, Germany</p>
	<p>Unique product identifier. Identifier for clear and unequivocal product identification.</p>
	<p>Temperature limit. Indicates temperature range (without condensation) for transport , storage and operation.</p>
	<p>Humidity limitation. Relative humidity range (without condensation) for transport , storage and operation.</p>
	<p>Atmospheric pressure limitation. Atmospheric pressure range for transport, storage and operation.</p>

INTRODUCTION

- Thank you for purchasing a SENCOR brand product and we hope that you will be happy with it.
- Prior to using this device, please read the user's manual thoroughly, even in cases, when one has already familiarised themselves with previous use of similar types of devices.
- Only use the device in the manner described in this user's manual. Keep this user's manual in a safe place where it can be easily retrieved for future use. In the event that you hand the device over to somebody else, make sure to also include this user's manual.
- Carefully unpack the device and take care not to throw away any part of the packaging before you find all its parts. We recommend saving the original cardboard box, packaging material, purchase receipt and responsibility statement of the vendor or warranty card for at least the duration of the legal liability for unsatisfactory performance or quality. In the event of transportation, we recommend that you pack the device in the original box from the manufacturer.
- The package contains a digital blood pressure monitor (1x), a cuff with an air hose (1x) and a user's manual.

DESCRIPTION OF THE DEVICE

- | | |
|---|---------------------------------|
| A1 Display | A4 Memory button |
| A2 Select user / basic settings button | A5 Speaker |
| A3 On/Off button | A6 Input slot type USB-C |
-
- | | |
|--|--|
| B1 Time and date | B12 Sound off icon |
| B2 Acronym for systolic pressure | B13 Battery icon |
| B3 Systolic pressure value | B14 Blood pressure classification indicator |
| B4 Acronym for diastolic pressure | B15 Heartbeat frequency value |
| B5 Diastolic pressure value | B16 Average blood pressure icon |
| B6 Acronym for heart pulse rate | B17 Pressure unit |
| B7 Memory icon | B18 Irregular heart pulse rate icon |
| B8 Memory number | B19 "Stay still" icon (faulty measurement as a result of body movement) |
| B9 Heartbeat icon | |
| B10 Cuff located on arm detection | |
| B11 User icons | |
-
- | | |
|-------------------------------------|-------------------------------|
| C1 Battery compartment cover | C2 Battery compartment |
|-------------------------------------|-------------------------------|
-
- | | |
|--------------------|--------------------------------------|
| D1 Cuff | D3 Air hose plug |
| D2 Air hose | D4 Air hose connection socket |

PURPOSE OF USE

- This digital blood pressure monitor is intended for fully automatic blood pressure measurement on the arm of an adult person and is suitable for household use. Together with blood pressure, it also measures the pulse rate.
- This digital blood pressure monitor utilises an oscillometric blood pressure measurement method. This means that it detects the movement of blood through the brachial artery and converts this movement into a digital value.
- The inflation and deflation of the cuff is performed automatically and does not require any action from the user.

**Note:**

Prior to first use of the device, carefully read this user's manual because the correct measurement of blood pressure is only possible when the device is operated correctly.

WHAT YOU SHOULD KNOW ABOUT BLOOD PRESSURE**WHAT IS BLOOD PRESSURE?**

- Blood pressure is defined as the pressure exerted by the blood on the walls of the arteries through which it flows. Blood pressure fluctuates during the course of each heartbeat between the maximum (systolic) and the minimum (diastolic) value. Blood pressure is influenced by many factors, such as physical activity, fear, anger or by a certain time of day.
- Blood pressure changes constantly over the course day. Early in the morning it rises and before noon it falls. In the afternoon it rises again and then falls in the evening hours. Blood pressure may also change within an instant and so the subsequent measurement results may vary.

WHY IS IT IMPORTANT TO MEASURE YOUR BLOOD PRESSURE AT HOME?

- The difference between the blood pressure measurement at home and in the hospital is approximately 20–30 mmHg (2.7 kPa – 4.0 kPa). This is the result of the fact that people are usually more relaxed at home than at the hospital. This is the so-called white coat syndrome and may affect up to 15 % of the population.
- Home blood pressure measurement eliminates the white coat syndrome and provides the doctor with a picture of the various blood pressure levels during your natural activity.

BLOOD PRESSURE CLASSIFICATION

- To determine blood pressure, it is necessary to measure two values:
 - Systolic (top) blood pressure: This is the value that is generated at the moment when the heart muscle contracts and blood is pumped into blood vessels.
 - Diastolic (bottom) blood pressure: This is the value that is generated when the heart muscle is expanded and is again filling up with blood.
- The measured heart pressure values are designated in millimetres of mercury (mmHg).
- The following table shows the blood pressure classification for an adult person according to the World Health Organisation (WHO).

Blood pressure category	Systolic blood pressure (mmHg)	Diastolic blood pressure (mmHg)
Optimal	<120	<80
Standard	120–129	80–84
High normal	130–139	85–89
Hypertension: Stage 1 (mild)	140–159	90–99
Hypertension: Stage 2 (medium)	160–179	100–109
Hypertension: Stage 3 (heavy)	≥180	≥110
Isolated systolic hypertension	≥140	<90

WHAT IS HYPERTENSION

- Hypertension (high blood pressure) is a serious illness that may negatively affect the quality of life. It may lead to a large number of health problems such as heart failure, kidney failure or bleeding into the brain. Hypertension and associated illnesses can be treated well if identified in time. For this, it is necessary to maintain a healthy lifestyle and to regularly visit your medical doctor for check ups.

**Note:**

Do not worry if you have measured an abnormal blood pressure values. Blood pressure can be better assessed individually after 2 or 3 measurements performed always at the same time of day over a longer time period. If your results are still abnormal, please consult your medical doctor.

**Note:**

Always replace the battery when:

- the display is dim or hard to read
- the display does not turn on
- the display shows the symbol 

WHAT IS CARDIAC ARRHYTHMIA?

- Cardiac arrhythmias are a disorder of the rhythm of the heartbeat. They result from a varied creation or conduction of electrical impulses in the heart. Many cardiac arrhythmias are only temporary in nature. Such types of arrhythmias are considered to be harmless and include the cases where the heart misses or adds a beat. This may be caused by strong emotions or exercise. However, there exist types of arrhythmia, which may be life threatening and require professional treatment. Symptoms of cardiac arrhythmia
- Symptoms of cardiac arrhythmia: strong or accelerated beating of the heart, feeling of tiredness, vertigo, loss of consciousness, lack of breath and chest pain.
- Symptoms of bradycardia (slowed down heart activity): feeling of tiredness, lack of breath, vertigo or dizziness.
- Symptoms of tachycardia (accelerated heart activity): the heartbeat may be felt in the neck or as a beat in the chest with irregular speed, feeling of unease, weakness, lack of breath, dizziness, sweating and vertigo.

CAN CARDIAC ARRHYTHMIA BE TREATED?

- Cardiac arrhythmia can to a certain extent be prevented by eliminating the stimuli (physical exertion, stress, smoking, consumption of alcohol, coffee or other beverages containing caffeine) affecting the nervous system. Many types of cardiac arrhythmias do not require treatment as they are naturally compensated by the immune system. Other types of cardiac arrhythmias must be treated with medication (antiarrhythmic agents), defibrillator implants or pacemakers. The treatment method depends on the type of cardiac arrhythmia, age of the patient and their physical condition. In any case, diagnosis of heart arrhythmia always requires consultation with a medical doctor.

PREPARING FOR USE**INFORMATION ABOUT THE POWER SOURCE**

- The device can be powered using 4 standard type AAA (1.5 V) batteries or using a power adapter (5 V DC) with a USB-C connector that is inserted into the socket **A6** on the side of the device. Neither the adapter nor the batteries are included.





INSERTING BATTERIES

- Remove the battery compartment cover and insert 4 type AAA alkaline batteries. When inserting the batteries ensure the correct polarity as shown in the battery compartment. Close the cover.





**Attention:**

If the polarity marked inside the cover is reversed when the batteries are inserted, the device may not function but may also heat up. Do not combine used and new batteries or batteries of various types, e.g. alkaline batteries and rechargeable batteries. When you will not be using the device for an extended period of time, take out the batteries. A flat battery is damaging to the environment; do not throw it out with household waste. Take the flat battery out of the device and proceed according to local recycling codes. Do not throw batteries into a fire. The batteries may explode or leak out.



SETTING THE DATE AND TIME

- Prior to using the blood pressure monitor, it is important to correctly set the date and current time so that the correct time and date information is saved in memory together with the measured blood pressure reading.
- When the blood pressure monitor is turned off, press and hold the  button for approximately 3 seconds in order to enter the date and time setting mode. The year number will start flashing first.
- Using the  button, set the required year number and confirm by pressing the  button. The item will automatically be saved and the month number will start flashing.
- In the same way as the year number, set the month number and then subsequently the hours and the minutes. Save the set date and time by pressing the  button.
- When you have finished setting the date and time, the device will automatically enter the sound settings mode, which is indicated by the  symbol. Proceed according to the following chapter.





SETTING THE SOUND

- When, after setting the date and time, the symbol  appears on the display, it is possible to set whether the device will have sound turned on or off.
- Using the  button, select option  (sound on) or option  (sound off). Save your selection by pressing the  button.

SETTING THE UNITS

- The device enables blood pressure to be displayed in two units, i.e. either in mmHg or kPa. The default unit is mmHg.
- When the blood pressure monitor is turned off, press and hold the START/STOP button for approximately 5 seconds in order to enter the units setting mode.
- Press the  button to toggle between the units of mmHg and kPa.
- Save your unit selection by pressing the  button.

SELECTING A USER

- The blood pressure monitor enables two persons to save their measured values. Prior to every measurement, it is necessary to select the correct user. When the blood pressure monitor is turned off, press the  button. The  icon of the first user will appear. Pressing  again will show the  icon of the second user.

BEFORE STARTING MEASUREMENT**Rules for achieving the most accurate measuring results**

- Always take measurements at the same time of day, ideally in the morning, at noon and in the evening under the same conditions or according to the recommendations of your doctor. Due to the fact that you can measure a wide range of various blood pressure values during the day, the individual and random measurements do not have any informative value. Only regular measurements taken at the same time of day, carried out over a longer period of time, enable the meaningful assessment of blood pressure values.
- Remain still for at least 5 minutes prior to taking a measurement. Even work at a desk increases systolic blood pressure by 6 mmHg and diastolic blood pressure by 5 mmHg.
- Do not drink coffee or tea or smoke at least 30-45 minutes prior to taking a measurement. Do not eat or drink for approximately one hour prior to taking a measurement.
- Do not take a measurement if you feel a strong urge to go to the toilet. A full urinary bladder can cause an increase in blood pressure of approx. 10 mmHg.
- Wait at least 20 minutes after taking a hot shower or bath.

- Do not perform measurements in an excessively cold environment.
- Take the pressure measurement on a naked arm while sitting in the upright position. Do not move the arm to which the cuff is attached.
- During measurement, sit calmly, relaxed and don't talk. Talking increases values by approx. 6 – 7 mmHg.
- Prior to taking another measurement, wait approximately 4–5 minutes to allow the pressure in your blood vessels to fully relax.
- Take the measurements regularly. Even if your values improve, you should continue to monitor them yourself.



Note:

To prevent measurement inaccuracies caused by electromagnetic interference, do not use this device in the vicinity of mobile telephones or microwave ovens.

MEASUREMENT

ATTACHING THE CUFF

- Prior to putting on the cuff, insert the air hose plug of the cuff into the socket on the device, see fig. **D**.
- Do not mechanically constrict the air hose of the cuff, do not squeeze or bend it.
- Remove all tight clothing from the arm before attaching the cuff.
- Slide the hand into the cuff and move it to the upper arm. The Cuff should be located at the same level as your heart, which means that the bottom edge of the cuff is approximately 2 - 3 cm above the elbow pit, see fig. **E**.
- Fastening the cuff The cuff must not be too loose or too tight. There must be sufficient space between the arm and the cuff to enable one finger to be inserted. The air hose must not be crossed and must lead along the inner side of the arm, forearm, going towards the palm.

SITTING CORRECTLY DURING MEASUREMENT

- Sit down in a calm place at a table or another suitable surface. If sitting in a chair, comfortably lean against the backrest.
- Position your feet next to each other with their entire surface on the floor. Do not cross your legs.
- Place your forearm with your palm facing upwards in a relaxed manner on to the surface of the table and check that the cuff and the air hose are in the correct location, see fig. **F**.



Note:

Blood pressure can be measured both on the left and the right arm. However, the measurement results from the left and right arm may differ, and for this reason it is necessary to perform repeated measurements always on the same arm.

COLOUR HIGHLIGHTED DISPLAY

- Values of the measured blood pressure are shown on the display not only by means of numbers but also by means of the background colour of the display. The background colour differs based on the measured pressure as follows:

Background colour	Meaning	Systolic pressure (mmHg)	Diastolic pressure (mmHg)
Red	High pressure	≥ 160	≥ 100
Yellow	Increased pressure	140–159	90–99
Green	Normal pressure	90–139	60–89
Yellow	Low pressure	< 90	< 60

MEASURING BLOOD PRESSURE

- Always start the measurement process after attaching the cuff.
- In the event that the device is also used by another person, check that your user profile is selected, see chapter SELECTING A USER.

- Press the START/STOP button. The display will momentarily show all the symbols and then **00** will appear.
- The device will automatically pressurise the cuff. During the pressurisation process, the pulse rate is detected, which is indicated by the symbol on the display.
- If the cuff is correctly fitted, the symbol will be displayed for the entire duration of measurement. If the symbol appears, it means that the cuff is too loose and it needs to be tightened. If the symbol starts flashing, stop the measurement by pressing the START/STOP button. Wait 4-5 minutes and then perform the measurement again.
- After pressurisation, the pressure in the cuff is continuously released and the values of the systolic (SYS) and diastolic (DIA) pressure and pulse frequency are automatically determined. The values will be shown on the display.
- If the symbol appears during measurement, it means that you have moved during the measurement and the measurement may not proceed correctly. If this happens, end the measurement process, wait 4-5 minutes and take the measurement again.



Attention:

Do not move or talk during the entire time of the measurement. If you feel unwell during the measurement process, immediately stop the measurement by pressing the START/STOP button.



Note:

If the symbol appears then the device has detected cardiac arrhythmia, see chapter WHAT IS CARDIAC ARRRHYTHMIA?

If this symbol appears frequently, it may indicate a malfunction of the heart's rhythm. If this happens contact your medical doctor.

MEMORY FUNCTION

- The values of each measurement are automatically saved for the respective user. This device is able to save up to 199 sets of measurements for each user. As soon as the memory capacity is full, the old values will be replaced by the new ones.
- With the device turned off, press the button. The device will display the average blood pressure measurement value for the last 2 or 3 measurements. Pressing the button again will show the last measured value. Pressing the button again will show the remaining measured values, one after the other.

DELETING VALUES FROM MEMORY

- With the device turned off, press the button and select the user, whose measured values you wish to delete from memory.
- Press the START/STOP button and then the button. This will activate the display.
- Press and hold down the button for approximately 3 seconds. This will delete the memory and the symbol will appear on the display.

ERROR CODES

- In the event that the measurement is not proceeding correctly, an error code will appear on the display. Their meanings are as follows:

Error code	Meaning, solution if necessary
Er U	The pressure 30 mmHg (4 kPa) was not achieved within 12 seconds. Repeat the measurement.
Er H	The inflation reached a value of 295 mmHg and after 20ms the device will deflate automatically.
Er 1	It was not possible to correctly measure the pulse. Check that the cuff is correctly fitted. Do not talk or move during the measurement. Relax for a few moments and then repeat the measurement.
Er 2	Too many disruptive effects (movement, speaking or magnetic interference during the measurement) Relax for a few moments and then repeat the measurement.

Er 3	The measurement result is abnormal. Relax for a few moments. Put the cuff back on and repeat the measurement. If the problem persists, please contact your doctor.
Er 23	The systolic pressure value is less than 57 mmHg.
Er 24	The systolic pressure value is greater than 255 mmHg.
Er 25	The diastolic pressure value is less than 25 mmHg.
Er 26	The diastolic pressure value is greater than 195 mmHg.

TROUBLESHOOTING

- In this chapter you will find solutions to problems that you may encounter when using this device. If you were unable to remedy the problem according to the following instructions, contact an authorised service centre.

Problem	Possible cause	Solution
The device did not turn on.	Check that the power supply is sufficient.	Replace the batteries or connect a power adapter with a USB-C type cable.
	Check that the positive and negative poles of the battery are not installed in reverse.	Install the batteries correctly.
Pressurisation is not occurring.	Check that the air hose is correctly connected to the device.	Insert the air hose plug properly into the socket in the device.
	Check that the air hose has not cracked or been damaged in any other way.	Contact the vendor and request a new cuff.
The measurement did not occur, no value was displayed or improbable values were measured.	The arm was moved during the measurement.	Keep the arm and the whole body still.
	Talking during measurement.	Do not talk while measuring blood pressure.
Air leaking out of the cuff	The cuff is fitted too tightly or is incorrectly located on the arm.	Check the fitting and location of the cuff.
	The cuff is torn or otherwise damaged.	Contact the vendor and request a new cuff.
The blood pressure value that is measured at home is higher than the value measured at the doctor	The cuff may be incorrectly positioned on the arm. If this happens, no blood pressure value may be measured or the value may be much higher than it is in reality.	Check the fitting and location of the cuff.
	The cuff is not fitted sufficiently firmly. If the cuff is loose, the compression force may not be transferred to the artery, which will cause the blood pressure value to be much higher than it actually is.	
	You are not sitting correctly. You must not slouch, bend over, bend or sit with crossed legs or in a position where the arm with the cuff is located below the level of the heart.	Reacquaint yourself with the instructions and recommendations for correct seating provided in this user's manual.



Attention:

In the event that it is not possible to measure the blood pressure even after trying all the above mentioned solutions, please contact the vendor. DO NOT ATTEMPT to disassemble this device or to repair it on your own.

TURNING OFF THE DEVICE

- Turn off the device by pressing the START/STOP button. If you do not turn off the device using this button and do not press any button within 1 minute then the device will turn itself off automatically.
- After turning off the device, disconnect the air hose. ATTENTION: When disconnecting the air hose, pull on its plug, never pull on the actual hose!

CLEANING AND MAINTENANCE



Warning:

The device must always be turned off before cleaning it. Do not wash the device or the cuff under running water or submerge it in water!

- Clean the device only with a soft, damp cloth. Do not use thinners, alcohol and other cleaning agents or solvents.
- You can carefully clean the cuff using a dampened cloth and a gentle soap solution. Never submerge the cuff in water.
- In order to prevent infections, especially when the device is used by multiple users, we recommend to clean and disinfect the cuff regularly or after every use. Especially the inner side of the cuff must be disinfected by wiping. ATTENTION: Do not perform disinfection by means of methods such as high-temperature steam or ultra-violet radiation. This could result in damage to the device and its shorter lifespan.
- Use disinfectants that are compatible with the material of the cuff, for example generally available 75% alcohol disinfectant spray. For protection against external effects, keep the device and the cuff together with this user's manual in a case.

CALIBRATION

- To ensure accurate measurement results we recommend the device is calibrated after two years of operation. All costs associated with the calibration are borne by the customer. Metrological inspection may only be performed by authorities or authorised workplaces providing servicing services for healthcare equipment.

STORAGE

- When not using the device for an extended period of time, remove the batteries.
- Protect the device against impacts and falls. Do not place any items on the stored device.
- Store the device in a clean, dry place out of reach of children. Do not expose the device to direct sunlight or extreme temperature changes. More in the technical specifications below.

TECHNICAL SPECIFICATIONS

Power source..... 4x 1.5 V AAA-type batteries; optional 5 V power adapter, USB-C connector

Display..... 4.2" (81.2 × 70.9 mm)

Outer dimensions..... 130 × 100 × 60 mm

Adjustable length of the cuff..... 22–42 cm

Measurement method..... Oscillometric

Measurement range..... Systolic pressure (SYS): 57–255 mmHg (7.6–33.4 kPa)
Diastolic pressure (DIA): 25–195 mmHg (3.33–26 kPa)
Pulse: 40–199 pulses / minute

Measurement accuracy..... Pressure: ± 3 mmHg (0.4 kPa) at a temperature of 5–40 °C
Pulse: ± 5 %

Operating mode..... Continuous

Memory capacity..... 2 × 199 measurements

Operating temperature range..... 5–40 °C

Relative humidity range..... 15–90 % (non-condensating environment, however without water vapour)

Atmospheric pressure range..... 70 kPa – 106 kPa

Transport/storage temperature..... -20 °C – 50 °C

Relative humidity range for storage..... 10 % – 93 % (non-condensating environment)

Protection level..... Type BF

Protection class level against damaging entry of water..... IP21

Automatic shut-off..... 1 minute of inactivity

Weight (without batteries)..... approx. 263 g

Expected lifetime of the device..... 5 years

Software version..... V1.0

Explanation of technical terminology

Protection class level against damaging entry of water:
IP21– Device is protected against solid foreign objects of size 12.5 mm and larger and against vertically falling water drops)

Changes to text and technical parameters are reserved.

INFORMATION RELATING TO ELECTROMAGNETIC COMPATIBILITY

- This arm cuff blood pressure monitor is intended for use in the electromagnetic environment described below. The customer or user of this arm cuff blood pressure monitor must ensure that it is used in such an environment.

Emissions	Compliance	Electromagnetic environment – rules
High-frequency emissions according to CISPR11	Group 1	This device utilises high-frequency energy exclusively for its internal functions. Therefore, its high-frequency emissions are very low and it is improbable that these could cause interference to other electronic devices and equipment in the vicinity.
High-frequency emissions according to CISPR11	Class B	This blood pressure measurement device is suitable for use in all environments including households and in such environments that are directly connected to public low-voltage power grids that are used to power building for residential purposes.

THE DIRECTIVE AND STATEMENT OF THE MANUFACTURER – RESISTANCE AGAINST ELECTROMAGNETIC INTERFERENCE

- This arm cuff blood pressure monitor is intended for use in the electromagnetic environment described below. The customer or user of this arm cuff blood pressure monitor must ensure that it is used in such an environment.

Tests of resistance against interference	Test level IEC 60601	Satisfactory level
Electrostatic discharge (ESD) according to norm IEC 61000-4-2	contact discharge ± 8 kV contact discharge ± 2 kV, ± 4 kV, discharge via air ± 8 kV, ± 15 kV	contact discharge ± 8 kV contact discharge ± 2 kV, ± 4 kV, discharge via air ± 8 kV, ± 15 kV
Electrostatic discharge (ESD) according to norm IEC 61000-4-2	contact discharge ± 8 kV contact discharge ± 2 kV, ± 4 kV, discharge via air ± 8 kV, ± 15 kV	contact discharge ± 8 kV contact discharge ± 2 kV, ± 4 kV, ± 8 kV, discharge via air ± 15 kVh
Magnetic field at a power frequency of 50/60 Hz according to norm IEC 61000-4-8	30 A/m	30 A/m
High-frequency radiation according to norm IEC 61000-4-3	10 V/m 80 MHz – 2.7 GHz 80 % AM at 1 kHz	10 V/m 80 MHz – 2.7 GHz 80 % AM at 1 kHz

THE DIRECTIVE AND STATEMENT OF THE MANUFACTURER – RESISTANCE AGAINST ELECTROMAGNETIC INTERFERENCE

- This arm cuff blood pressure monitor is intended for use in the electromagnetic environment described below. The customer or user of this arm cuff blood pressure monitor must ensure that it is used in such an environment.

High-frequency radiation (HF) RFO-4-3 (Test specifications of RESISTANCE TO EMISSIONS VIA THE COVER OF THE DEVICE against HF wireless communications equipment)							
Test frequency (MHz)	Band (MHz)	Service	Modulation	Maximum power (W)	Distance (m)	IEC 60601-1-2 Test level (V/m)	Conformity level (V/m)
385	380–390	TETRA 400	Pulse Modulation 18 Hz	1.8	0.3	27	27
450	430–470	GMRS 460, FRS 460	FM \pm 5 kHz deviation 1 kHz sin	2	0.3	28	28
710	704–787	LTE band 13, 17	Pulse Modulation 217 Hz	0.2	0.3	9	9
745							
780							
810	800–960	GSM 800/900, TETRA 800, DEN 820, CDMA 850, LTE band 5	Pulse Modulation 18 Hz	2	0.3	28	28
870							
930							
1,720	1,700–1,990	GSM 1800, CDMA 1900, GSM 1900, DECT; LTE band 1, 3, 4, 25, UMTS	Pulse Modulation 217 Hz	2	0.3	28	28
1,845							
1,970							
2,450	2,400–2,570	Bluetooth, WLAN, 802.11 b/g/n, RFID 2450, LTE band 7	Pulse Modulation 217 Hz	2	0.3	28	28
5,240	5,100–5,800	WLAN 802.11 a/n	Pulse Modulation 217 Hz	0.2	0.3	9	9
5,500							

Emitted RF IEC61000-4-39 (Test specifications of RESISTANCE TO EMISSIONS VIA THE COVER OF THE DEVICE against nearby magnetic fields)			
Test frequency	Modulation	IEC 60601-1-2 Test level (A/m)	Conformity level (A/m)
30 kHz	CW	8	8
134.2 kHz	Pulse modulation 2.1 kHz	65	65
13.56 kHz	Pulse modulation 50 kHz	7.5	7.5



Note:

The optional power adapter must meet the requirements of norm IEC 60601-1.
Use only the power adapter specified by an authorised vendor. Other adapters may differ in their output voltage and polarity and may present a risk to your life or damage of this device.

.....

INSTRUCTIONS AND INFORMATION REGARDING THE DISPOSAL OF USED PACKAGING MATERIALS

Dispose of used packaging material at a site designated for waste in your municipality.

DISPOSAL OF USED BATTERIES



Batteries contain environmentally damaging compounds and, therefore, do not belong in standard communal waste. Hand over used batteries for proper disposal at locations intended for their collection.



DISPOSAL OF USED ELECTRICAL AND ELECTRONIC EQUIPMENT



This symbol on products or original documents means that used electric or electronic products must not be added to ordinary municipal waste. For proper disposal, renewal and recycling, hand over these products at determined collection points. Alternatively, in some European Union states or other European countries you may return your products to the local retailer when buying an equivalent new product. Correct disposal of this product helps save valuable natural resources and prevents potential negative effects on the environment and human health, which could result from improper waste disposal. Ask your local authorities or collection facility for more details. In accordance with national regulations penalties may be imposed for the incorrect disposal of this type of waste.



For business entities in European Union states

If you want to dispose of electric or electronic equipment, ask your retailer or supplier for the necessary information.

Disposal in other countries outside the European Union.

This symbol is valid in the European Union. If you wish to dispose of this product, request the necessary information about the correct disposal method from the local council or from your retailer.



This product meets all the basic requirements of EU directives related to it.

