

SENCOR®

SDH 1028WH



SMART MOBILE DEHUMIDIFIER WI-FI
Translation of the original manual



SENCOR®

SDH 1028WH

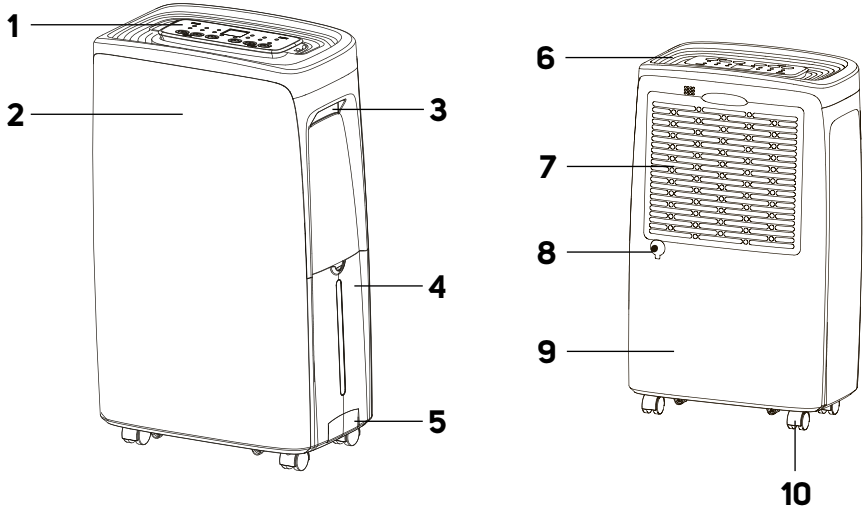
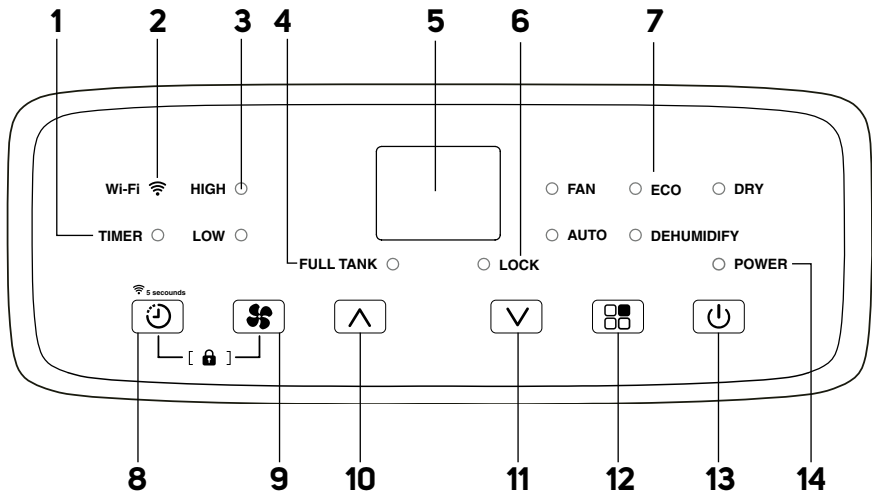

A**B**

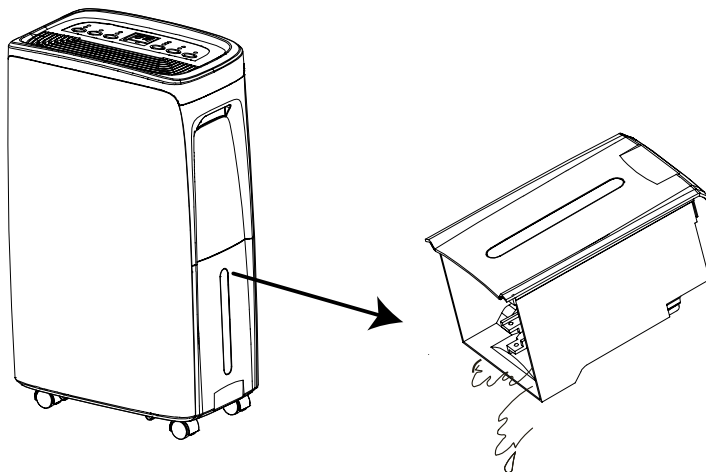
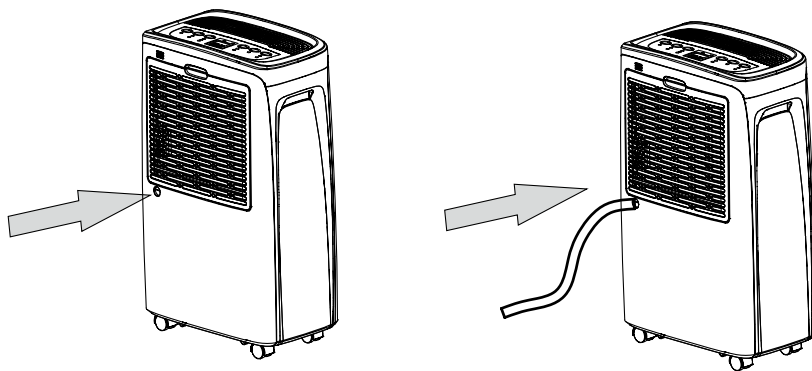
C**D**

EN Smart Mobile Dehumidifier Wi-Fi

Important Safety Instructions

READ CAREFULLY AND STORE FOR FUTURE USE.

- This appliance may be used by children 8 years of age and older and by persons with physical, sensory or mental impairments or by inexperienced persons, if they are properly supervised or have been informed about how to use of the product in a safe manner and understand the potential dangers.
- Cleaning and maintenance performed by the user must not be performed by unsupervised children. Children must not play with the appliance.
- If the power cord is damaged, it must be replaced by an authorised service centre or by another similarly qualified person, this will prevent the creation of a dangerous situation. It is forbidden to use the appliance if it has a damaged power cord.
- The appliance must be installed in accordance with national installation codes.
- The appliance must be stored in a manner that prevents its mechanical damage.
- The appliance must be stored in a well ventilated location, where the dimensions of the room correspond to the dimensions specified for its operation.

- The appliance must be stored in a room where an open flame is not continuously in use (e.g. running gas appliance) or where there are sources of ignition (e.g. running electrical heating element).
- Before connecting the appliance to a power socket, check that the rated voltage on its rating label matches the electrical voltage in the power socket.
- Connect the appliance only to a properly grounded socket.
- The power socket must be freely accessible so that it is possible to quickly disconnect the power cord from the power source if necessary.
- The appliance is designed for use in household, offices and similar types of areas. Do not use it in rooms where it could be exposed to dripping or spraying water, where it could be exposed to direct sunlight, in areas where chemical or explosive substances are stored, in industrial surroundings or outdoors! Do not use it in the vicinity of a bath, shower, swimming pool, etc.
- Do not place the appliance in the vicinity of an open flame or appliances that are sources of heat.
- Do not place the appliance on unstable surfaces such as carpets with very long and thick fibres.
- The appliance may only be used on a dry, stable, smooth and horizontal surface.
- The appliance is equipped with travel wheels so pay extra attention when handling it so that it does not fall down stairs or travel down from sloped areas. If necessary secure the wheels using the stoppers.
- Only use original parts to assemble the appliance. Before starting to assemble the appliance, make sure that it is turned off and disconnected from the power socket.
- Prior to connecting the appliance to a power socket, make sure that the appliance is correctly assembled according to the instructions in this user's manual.
- Do not touch the appliance with wet or damp hands. This applies especially when it is connected to a power socket.
- Do not submerge the appliance in water or in any other liquid.
- Do not cover or insert anything into the air inlet or air outlet openings. This could damage the appliance.
- During operation, there must be sufficient space for air circulation with at least 30 cm of free space on all sides.
- Do not expose yourself to a cold air current for a long time. This could have a negative effect on your health.
- To turn the appliance on or off, always use the appropriate buttons on the control panel. Do not turn off the appliance by disconnecting the power cord from the power socket.
- Always turn off the appliance and disconnect it from the power socket when leaving it without supervision, when not using it and before moving, disassembling or cleaning it.
- Do not attempt to remove the outer case of the appliance.
- Unplug the appliance from the power socket by pulling the plug, not the power cord. Otherwise, damage to the power cord or the socket could occur.
- Do not use the appliance if it is damaged in any way, or with a damaged mains cable or plug.
- Store the appliance in a vertical position. It may only be transported in the vertical position. If you have already used the appliance, check that all the condensate has been drained. After transporting it, wait at least 1 hour before using the appliance.
- Do not use the appliance if it is not working correctly, if it has been damaged or has been submerged in water. To avoid a hazardous situation arising, do not repair the device yourself or modify it in any way. Have all repairs or adjustments performed at an authorised service centre. By tampering with the appliance, you expose yourself to the risk of losing your legal rights regarding faulty performance or warranty for quality.
- This appliance is intended for use by experts or trained personnel in stores, light industry and in agriculture, or for commercial use by ordinary people.



Read this user's manual carefully prior to installing or operating your new appliance. Make sure that you keep it for future reference.



Read the technical documentation.



Read the user's manual.



Fire hazard.

The appliance contains a flammable refrigerant. It is necessary to adhere to safety instructions.

SPECIFIC INFORMATION FOR APPLIANCES USING REFRIGERANT GAS R290

- Carefully study all the warnings.
- For defrosting and cleaning, do not use any other tools than those recommended by the manufacturer.
- The appliance must be stored in a room where there are no sources of ignition (e.g. open flame, gas appliance in operation, electrical heating equipment in operation) in continuous operation.
- Do not puncture or burn the cooling circuit.
- It is necessary to take into consideration that refrigerants may be odourless.
- The appliance must be installed, operated and stored in a room with a floor area greater than 2m².
- This appliance contains 40 g of refrigerant gas R290.
- R290 is a refrigerant gas that meets European environmental protection directives. Do not drill into or damage any part of the cooling circuit.
- Sufficient ventilation must be provided in the room where this appliance is installed operated or stored. Otherwise, there is a risk of an explosion or fire in the event that leaked refrigerant ignites, e.g. when a gas cooker is turned on, etc.
- The appliance must be stored in such a manner that its mechanical damage is prevented.
- Persons working with or repairing cooling circuits must have appropriate authorisation issued by an authorised institution that certifies this person's competence to work with refrigerants in accordance with the specific assessment of the association for this sector.
- Maintenance tasks must be performed solely on the basis of the recommendations of this appliance's manufacturer. Maintenance and repair tasks that required the contribution of other qualified expert personnel may only be performed under the supervision of specialised experts in the flammable refrigerants sector.
- Check the rating label for the type of refrigerant gas used in your appliance.
- Do not cover the vents.
- Adhere to national codes relating to gas.

- Thank you for purchasing our SENCOR product; we hope you will be satisfied with it.
- Before using this appliance, please familiarise yourself with the user's manual, even if you are already familiar with using similar types of appliances. Use the appliance only as described in this user's manual. Keep the manual for future reference.
- We recommend to keep the original packaging, packaging materials, receipt, and proof of the seller's liability or warranty certificate for a minimum of the duration of statutory right of faulty performance or warranty of quality. When transporting the appliance, we recommend packaging it again in the original box provided by the manufacturer.



Note:

- Do not travel over carpets, door thresholds or other obstacles with the wheels. This may lead to their damage.
- Do not move the appliance when the condensate tank is full.

DESCRIPTION OF THE APPLIANCE

- | | |
|--|---|
| A1 Control panel | A7 Outlet plug for drain hose connection |
| A2 Front panel | A8 Rear panel |
| A3 Handles (located on both sides) | A9 Travel wheels |
| A4 Handle for tank ejection | Without illustration: power cord, drain hose |
| A4 Condensate tank | |
| A5 Air outlet grille | |
| A6 Air intake grille with built-in filter | |

DESCRIPTION OF THE CONTROL PANEL

- | | |
|--|---|
| B1 Timer indicator light | B10 button: used to set the humidity / extend the timer time |
| B2 Wi-Fi icon | B11 button: used to set the humidity/reduce the timer time |
| B3 Fan speed indicator lights | B12 button: used to select the operating mode |
| B4 Full tank indicator light | B13 button: used to turn on/off |
| B5 Display (shows current relevant humidity and desired dehumidification level) | B14 Dehumidifier on indicator light |
| B6 Control panel lock indicator light | |
| B7 Operating mode lights | |
| B8 button: used to set the timer | |
| B9 button: used to set the fan speed | |



Note:

The combination of buttons and is used to activate/deactivate the child lock – see the instructions below for more information.

PURPOSE OF USE

The dehumidifier is used to reduce the humidity in the room.

BEFORE FIRST USE

- Before first use, remove the appliance and its accessories from the packaging and remove all promotional labels and tags. Check that neither the appliance nor any of its components is damaged.
- Pull out the condensate tank and remove the drain hose from the condensate tank.
- After unpacking, let the dehumidifiers stand for 2 to 3 hours to allow the refrigerant in the cooling circuit to settle.
- Transport the dehumidifier only in the vertical position. We do not recommend transporting it in a horizontal position or tilting it.

INSTALLATION LOCATION OF THE APPLIANCE

- Locate the appliance on an even, dry and stable surface within reach of a properly grounded power socket.
- Do not use the product outdoors.
- To ensure sufficient air circulation, leave at least 30 cm of free space around the appliance.
- Place the appliance in a room where the temperature does not fall below 5°C. Frost could form in the appliance if the temperature drops below 5°C and the appliance would need to be defrosted.
- Do not locate the appliance in the vicinity of dryers, heating devices and other sources of heat. Avoid location in direct sunlight.
- Do not use the appliance in locations where humidity could damage books or other valuable items.
- The appliance must be used in a closed room in order to ensure its maximum effectiveness. Therefore, close the doors and windows of the given room.

OPERATING THE APPLIANCE

- The dehumidifier is used to reduce the humidity in a room, e.g. to dry out flooded cellars, rooms with increased humidity, etc. Do not use it in areas where substances or objects are stored that require precise temperature and humidity control in the room.
- Use the appliance at an ambient temperature 5 and 35°C and humidity between 30% and 80%. These values will ensure the most effective operation of the dehumidifier.
- Always wait at least 3 minutes before turning the appliance on again.
- Do not connect the appliance to a power socket to which another appliance is already connected. We recommend connecting the appliance to an independent circuit.
- Make sure that the condensate tank is correctly installed in the appliance, otherwise the appliance may not function correctly.

OPERATING THE APPLIANCE

- Make sure that the appliance is located in a suitable place and that it is correctly assembled. Then insert the power plug into a power socket. A sound is made. The dehumidifier is in stand-by mode.

Turning On/Off

- Press the button to turn on the dehumidifier. An audible warning will sound once. The power indicator light will be lit. The button lights up green.
- The dehumidifier starts automatically in the default dehumidification mode (default relative humidity 40%). The display will show the humidity in the room and the fan will start running.
- If you need to turn off the appliance, press the button and the indicator light will turn off. The button will light up red. The dehumidifier is now in stand-by mode.
- If you need to turn the appliance off completely, pull the power plug out of the power socket.
- The operation of the dehumidifier will stop automatically if the condensate tank is full or incorrectly installed.

**Note:**

After turning off the dehumidifier with the  button, the appliance will run for about 1 minute and then switch off (except in fan mode). This is a normal occurrence.

If you turn off the dehumidifier while it is in continuous dehumidification or laundry drying mode, the fan will continue to run for about 3 minutes after it is turned off. This is normal and extends the life of the product.

Operating Mode Selection



Press the  button repeatedly to select one of the operating modes:

- FAN (fan mode)
- AUTO (automatic mode)
- ECO (energy saving mode)
- DEHUMIDIFY (dehumidifier mode)
- DRY (laundry drying mode)

Each press will illuminate the light of the selected mode.

1. Fan Mode (FAN)

In this mode, only the fan is in operation and the compressor is turned off. It is possible to set the fan speed, but it is not possible to set the relative humidity. The display will show the relative ambient humidity from 30% to 90%.

- Repeatedly press the  button until the FAN light comes on.
- Press the  button repeatedly and select the fan speed: HIGH or LOW. Each time the button is pressed, the respective indicator will be lit on the control panel.

2. Automatic Mode (AUTO)

In automatic mode, the target air humidity is set to 50%. The dehumidifier itself adjusts the settings according to the recorded relative humidity to achieve the target humidity. It is not possible to set the fan speed or the target humidity. The display shows the ambient air humidity of 30–90%.

- Repeatedly press the  button until the AUTO light comes on.
 - If the ambient humidity is $\geq 70\%$, the dehumidifier will be set to strong dehumidification.
 - If the ambient humidity is 50–70%, the dehumidifier will be set to weak dehumidification.
 - If the ambient humidity is $\leq 50\%$, the fan speed will be set to low.





3. Energy Saving Mode (ECO)

In energy saving mode, the default relative humidity is set to 60% and cannot be changed, nor can the fan speed. The dehumidifier monitors and records the relative humidity during operation and selects the operating mode accordingly.

- Repeatedly press the  button until the ECO light comes on.
- If the air humidity is $\geq 60\%$, the dehumidifier selects the dehumidification operating mode.
- If the air humidity is $\leq 60\%$, the dehumidifier will select the fan operating mode.

4. Dehumidifier Mode (DEHUMIDIFY)

This mode is suitable for ensuring constant removal of air humidity. We recommend connecting the drain hose to ensure constant drainage of condensate – see chapter **“CONTINUOUS CONDENSATE DRAINING VIA THE DRAIN HOSE”** for more information.

- Repeatedly press the  button until the DEHUMIDIFY light comes on.
- Use the  /  buttons to set the desired humidity between 35 and 85%. Each press of the  /  button increases/decreases the humidity by 5%. If you set the humidity below 35%, “CO” will appear on the display.

5. Laundry Drying Mode (DRY)

This mode is suitable for drying laundry at home. In this mode, the compressor is always running and the fan speed is automatically set to high regardless of the relative humidity in the room. To protect against damage, the compressor starts with a three-minute delay. The fan speed and the humidity level in the room cannot be set. The ambient relative air humidity level (30–90%) will appear on the display.



- Repeatedly press the  button until the DRYER light comes on.

- The dehumidifier switches to this mode. The fan starts running at high speed and the compressor starts 3 minutes later.







Automatic Turning Off/On

The dehumidifier is equipped with automatic turn-off and automatic turn-on after a set time.





1. Automatic Turning Off

- While the dehumidifier is in operation, press . The display will flash “00” and the timer light will illuminate.
- Use the  /  buttons to set the time after which the dehumidifier turns off. You can set the time from 1 to 24 hours.
- Wait for the set time to stabilise on the display and then the countdown will start automatically.
- After the set time has elapsed, the dehumidifier turns off and enters standby mode.

2. Automatic Turning On

- While the dehumidifier is in stand-by mode, press . The display will flash “00” and the timer light will illuminate.
- Use the  /  buttons to set the time after which the dehumidifier turns on. You can set the time from 1 to 24 hours.
- Wait for the set time to stabilise on the display and then the countdown will start automatically.
- After the set time has elapsed, the dehumidifier turns on.
- If you need to cancel the automatic switching off or on, press the  button briefly and use the  /  buttons to set the value to “00”.
- If you need to check the set time, press the  button briefly.

Control Panel Lock

- The lock enables the control panel elements to be locked in order to prevent accidentally changing your settings.
- Press and hold the  and  buttons simultaneously to activate the control panel lock. The control panel lock light comes on. All the buttons on the control panel will be inactive.
- To deactivate the lock, hold down the  and  buttons at the same time. The lock will be cancelled and the lock indicator light on the control panel will turn off.

CONTROL THROUGH THE Sencor HOME APP

- The dehumidifier can be controlled via the Sencor HOME application.
- Download the application to your smart phone, register yourself and control the dehumidifier via the application.



- If you already have the application installed, add the dehumidifier to your devices.

Adding the Dehumidifier to the Device List via Bluetooth

You can add the dehumidifier to the Sencor HOME application by pairing it via Bluetooth.

1. Turn on the Bluetooth function on your mobile phone.
2. Turn on the dehumidifier.
3. Open the app and on the app's home page, click the “+” icon in the top right corner.
4. The device itself will offer the “Add Device” option.
5. Click and the app will automatically guide you through adding it.

**Note:**

If the Bluetooth connection fails or is not possible, make sure there are no solid obstacles between your phone and the dehumidifier and that the two devices are close together.

Adding the Dehumidifier to the Device List via a QR code

- The dehumidifier can also be added to the Sencor HOME application using the QR code provided below. On the app's home page, click the "+" icon and on the add device screen, click "[-] Scan QR Code" in the top right corner.
- You will be prompted to reset the device. Hold down the  button for about 5 seconds. The Wi-Fi indicator light is blinking. This means that the dehumidifier is ready to be paired. Instructions can also be found on the application screen.
- In the app, confirm that the (Wi-Fi) light is flashing and click on "Next".
- The process of adding the device starts. Wait until the dehumidifier is paired.
- In the device list on the main screen, click on the icon of the dehumidifier to enter control interface.

QR Code for Adding the Control Panel of the Dehumidifier to the Sencor HOME App**Manually Adding the Dehumidifier to the Device List**

- On the main screen, click on "Add device" or "+" in the upper right corner and click on "Add device".
- A screen with appliance categories and a list of appliances will appear.
- Click on "Air quality" and select the dehumidifier model from the product list.
- You will be prompted to reset the device. Hold down the  button for about 5 seconds. The Wi-Fi indicator light is blinking. This means that the dehumidifier is ready to be paired. Instructions can also be found on the application screen.
- In the app, confirm that the (Wi-Fi) light is flashing and click on "Next".
- On the next screen, you will be prompted to select a Wi-Fi network. Select the network, enter your password and click "Next".
- The process of adding the device starts. Wait until the dehumidifier is paired.
- In the device list on the main screen, click on the icon of the dehumidifier to enter control interface.

Wi-Fi Reset

While the dehumidifier is in operation, press and hold down  button for 5 seconds. The Wi-Fi settings will be reset and the Wi-Fi icon will flash quickly (twice per second).

EMPTYING THE FULL TANK (FIG. C)

- If the condensate tank becomes full while the dehumidifier is in operation, the compressor and the fan will stop running, an audible warning will sound and the full tank light will flash on the control panel.
- Carefully pull the condensate tank out of the side of the dehumidifier and pour out the condensate. Insert the tank back. Make sure that it is properly inserted and the float rotates freely.
- When the condensate tank is reinstalled, the dehumidifier will automatically resume operation. When the dehumidifier is in the dehumidification mode, the compressor will start only after 3 minutes.

CONTINUOUS CONDENSATE DRAINING VIA THE DRAIN HOSE

A drain hose must be connected for continuous condensate drainage. Proceed as follows:

1. Remove the plastic plug at the rear of the outlet. Store the well for future use.

**Note:**

If there is water in the outlet after removing the plug, wipe it with a dry cloth.

2. Insert the end of the drain hose into the outlet. The internal diameter of the drain hose is 10 mm. Make sure the end of the hose is properly inserted to prevent condensate leakage (see Figures D).
3. Locate the free end of the hose so that the condensate can flow out freely. The container or the place where the condensate is drained must be lower than the outlet. Do not bend the hose or step on it.

**Note:**

When not using the drain hose for continuous draining of condensate, remove it, wipe away any water and close the outlet using the plug.

CLEANING AND MAINTENANCE

Disconnect the power plug from the power socket before cleaning.

**Note:**

Do not use abrasive cleaning agents, solvents, or any substances to clean any parts of the appliance that could damage the surface of the appliance.

**Warning:**

To prevent the risk of electric shock, do not submerge the appliance, plug or power cord in water or any other liquid.

Cleaning the Condensate Tank

- Empty out the condensate tank whenever you finish using the appliance and wipe it using a wiping cloth.
- To prevent undesirable bacteria, micro-organism or moulds from multiplying inside the tank, clean it out at least once per month using a cloth dampened in lukewarm water with the addition of neutral detergent. Then rinse it out thoroughly using clean water, wipe it dry and insert it back into the appliance.
- Do not wash the condensate tank in a dishwasher.

Cleaning the Protective Filter Grille

- Check and clean the protective grille at least once every two weeks, or more often if you use the appliance every day.
- Remove the protective filter grille from the dehumidifier.
- You can remove the dust using a brush with gentle bristles. If the filter grille is more heavily soiled, you can vacuum up the dust and dirt using the vacuum cleaner on its lowest setting and the fitted upholstery brush. Alternatively, you can soak the filter grille in warm water (water temperature maximum 40°C) and use a soft sponge to clean it. Leave in a dry, shady and well-ventilated place to dry. Do not use a dryer or hair dryer to dry. Do not dry in direct sunlight. Make sure the filter grille is completely dry before inserting it into the appliance.
- Install back in place.

**Warning:**

Do not use the appliance without the protective filter grille properly installed. Do not wash the protective filter grille in a dishwasher.

Cleaning the Outer Case

- To clean the outer casing, use a cloth slightly dampened with lukewarm water and a little dishwashing liquid. Make sure that water does not enter into the vents. In the event that air inlet and outlet grilles are only dusty, a vacuum cleaner may be used to clean them.

Storage

- When not using the appliance for an extended period of time, disconnect the power plug from the power socket and clean it according to the instructions provided above.
- Clean the condensate tank only 24 hours after turning the appliance off since even during this time a small amount of condensate may accumulate.
- Store the appliance in a dry, clean, and well-ventilated place away from extreme temperatures and out of the reach of children or pets.

TROUBLESHOOTING

Problem	Cause	Solution
The dehumidifier is emitting hot air.	This is a normal occurrence. Dehumidified air passes through a heating element, whereby the air is heated up (without the cooling function).	
The dehumidifier didn't turn on.	The dehumidifier is not connected to a mains socket.	Insert the power plug into a properly grounded power socket.
	Condensate tank is full.	Empty the condensate tank.
	The condensate tank is not inserted correctly.	Insert the tank correctly into the dehumidifier.
The dehumidifier is not removing humidity from the room.	Temperature and humidity in the room are low.	If the temperature and humidity in the room are low, reduce dehumidification power. Check the temperature and humidity in the room. As a rule, humidity will be higher during the cooler months. This is not a defect.
	The air outlet or air inflow is blocked.	Eliminate the cause of the blockage of the air outlet or inlet.
The dehumidifier does not exhaust air.	The protective filter grille is dirty.	Clean the protective filter grille.
The dehumidifier is noisy.	The dehumidifier is located on an uneven floor, is tilted, or is located on an unstable surface.	Place the dehumidifier on a flat, firm and stable surface.
	The protective filter grille is dirty.	Clean the protective filter grille.

In the event that the problem persists, or is not listed in the table above, stop using the appliance and contact an authorised service centre.

TECHNICAL SPECIFICATIONS

Power	220–240 V~, 50 Hz
Dehumidification capacity	10 l / 24 h (30°C/80%)
Rated power input	235W
Rated current	1A
Energy factor EEV	1.21 l/kWh
Starting current	3.5A
Fuse type and current value	Tube fuse 2 A
Condensate tank capacity	1.5 l
Coolant type and weight	R290/40 g
GWP (global warming potential)	3
CO ₂ equivalent (t)	0.00012
Air flow volume	120 m ³ /h (high)
Noise level	42/40 dB (A) (high/low speed)
Dimensions	293×493×183 mm
Net/gross weight	9.1/10.2 kg
Operating temperature	5–35 °C
Recommended room area	18–35 m ²

We reserve the right to change the text and technical specifications.

SENCOR hereby declares that the radio device type SDH 1028WH conforms to the 2014/53/EU directive. The full text of the EU Declaration of Conformity is available at: www.sencor.eu.

INSTRUCTIONS AND INFORMATION ON DISPOSAL OF USED PACKAGING MATERIAL

Dispose of used packaging material at a site designated for waste in your municipality.

DISPOSING OF USED ELECTRICAL AND ELECTRONIC EQUIPMENT



This symbol on the products or accompanying documents indicates that used electrical and electronic products should not be disposed of with regular municipal waste. For proper disposal and recycling, take these products to designated collection points. Or in some European Union states or other European countries the products can be returned to the local retailer when buying an equivalent new product. Disposing of this product correctly helps save valuable natural resources and prevents damage to the environment by improper waste disposal. Ask your local authorities or collection facility for more details. In accordance with national regulations penalties may be imposed for the incorrect disposal of this type of waste.

For Business Entities in European Union States

If you want to dispose of electric or electronic devices, ask your retailer or supplier for the necessary information.

Disposal in Other Countries Outside the European Union

This symbol is valid in the European Union. If you wish to dispose of this product, request the necessary information about the correct disposal method from the local council or from your retailer.



This product complies with all the essential requirements of the EU directives that apply to it.

SERVICING INSTRUCTIONS

- The service manual is intended only for qualified personnel with authorisation for handling flammable refrigerants.

1.1 Area check

Before starting work on a system containing flammable refrigerants, safety checks are necessary to ensure that the risk of ignition is minimised. When repairing a cooling system, the following measures must be adhered to prior to performing any work.

1.2 Work procedure

Work must be performed following a controlled procedure so that the risk of flammable gases or fumes being present during this time is minimised.

1.3 General work area

The whole maintenance crew and other personnel at the site must be informed about the nature of the works being performed. Work in tight areas must be prevented. The area around the work site must be divided into sections. It must be ensured that the conditions inside the area are safe by means of inspections of flammable materials.

1.4 Check for presence of a refrigerant

The area must be checked using an appropriate detector for the presence of refrigerant before and during work to ensure that technicians are aware of a potentially flammable atmosphere. It must be ensured that the device used for the detection of leaks is suitable for use on flammable refrigerants, i.e. non-sparking, appropriately sealed or intrinsically safe.

1.5 Presence of a fire extinguisher

In the event that any work is performed on the cooling device or associated parts under heat, then a suitable fire extinguisher must be on hand. In the vicinity of the filling area, there must be a powder or CO₂ fire extinguisher.

1.6 No ignition sources

No person performing work related to the cooling system that encompasses the uncovering of any pipes that contain or have contained flammable gasses may use any ignition sources in a manner that could lead to a fire or explosion hazard. All possible ignition sources, including the smoking of cigarettes should be kept at a sufficient distance from the installation, repair, removal or disposal location, during which flammable refrigerant could potentially be released into the surrounding environment. Prior to starting work, the area around the appliance must be checked to ensure that there are no fire hazards or ignition risks present. A "smoking forbidden" sign must be installed.

1.7 Ventilated area

It must be ensured that the area is ventilated or appropriately ventilated prior to penetrating the system or performing any work under heat. The intensity of ventilation must continue for the time that works are performed. Ventilation should safely dissipate any released refrigerant and draw it out into the atmosphere as a priority.

1.8 Cooling system checks

In places where electrical components are replaced, these components must be suitable for this purpose and conform to correct specifications. The manufacturer's instructions for maintenance and service must always be followed. If any doubts arise, it is necessary to request help from the manufacturer's technical department.

- On installations containing flammable refrigerants, it is necessary to perform the following checks:
 - the amount of refrigerant corresponds to the size of the room in which components containing refrigerant are installed;
 - ventilation systems and outlets are in full working order and are not clogged;
 - if any indirect cooling circuit is used, the second circuit must be checked for the presence of refrigerant;
 - the markings on the appliance must remain constantly visible and legible, and marking and signs that are illegible must be repaired;
 - The cooling pipes and components are installed in locations where it is not probable that they will be exposed to any substances that could corrode the parts containing refrigerant, unless these components are

built using materials that are inherently resistant to corrosion or are appropriately protected against corrosion.

1.9 Electrical device check

The repair and maintenance of electrical components must include safety checks and inspections of components.

In the event of a malfunction that could affect safety, no electrical power may be connected to the circuit until the malfunction is satisfactorily resolved. In the event that the malfunction cannot be immediately repaired but it is necessary to continue running the appliance, an appropriate temporary solution must be used. The owner of the appliance must be informed in such a way that all parties know about it.

The initial safety check must ensure:

- that capacitors are discharged: this must be performed in a safe way to prevent the possibility of sparking;
- that no electrical components or wiring is uncovered during the process of filling, draining or cleaning the system;
- that the grounding is not interrupted.

2. Repair of sealed components

When repairing sealed components, all the electrical power supply must be disconnected from the appliance on which work is being performed before sealed lids, etc. are removed. When it is absolutely necessary to have live power supply going into the appliance while servicing the appliance, it is necessary to install a permanent device in the most critical point to detect leakage so that a dangerous situation is averted.

Special attention must be paid to ensuring that as a result of the work performed on electrical components the cover is not changed to the extent of affecting the level of protection. This must also include damage to cables, excessive number of connections and terminals not performed according to original specifications, damaged gaskets, incorrect configuration of plugs, etc.

It is necessary to ensure that the appliance is mounted safely.

It is necessary to ensure that gaskets or sealing materials are not damaged in such a way that they no longer serve to prevent the entry of a flammable atmosphere. Spare parts must conform to the manufacturer's specifications.



Note:

The use of silicone gaskets and seals may suppress the efficiency of certain type of leak detection devices. Intrinsically safe components do not need to be disconnected prior to being worked on.

3. Repairs of intrinsically safe components

No permanently inductive or capacitive load may be placed on the circuit without it being ensured that thereby the permitted voltage and current for the used appliance is not exceeded.

Intrinsically safe components are the only type on which it is possible to work in a flammable environment even while under live current. Testing equipment must have correct specifications.

Parts are replaced using only parts specified by the manufacturer. Different parts could result in ignition of refrigerant upon leakage into the environment.

4. Cabling

Check that cabling is not exposed to wear and tear, corrosion, excessive pressure, vibrations, sharp edges or any other negative environmental effects. This check must also take into consideration the effects of ageing and permanent vibrations from sources such as compressors or fans.

5. Detection of flammable refrigerants

Under no circumstances may potential sources of ignition be used for locating or detecting refrigerant leaks.

A halogen burner (or any other type of detector utilising an open flame) must not be used.

6. Leak detection methods

The following leak detection methods are considered acceptable for systems containing flammable refrigerants.

For the detection of flammable refrigerants, electronic leak detectors must be used, however their sensitivity may not be appropriate or they may require recalibration. (Detection equipment must be calibrated in an area without any refrigerant present). It is important to ensure that the detector is not a potential ignition source and that it is suitable for the used refrigerant. The leak detector must be set to a percentage of LFL refrigerant and must be calibrated for the used refrigerant and the respective gas percentage is confirmed (maximum 25 %).

Leak detection liquids are suitable for use on most refrigerants, however, detergents containing chlorine must be excluded since chlorine may react with the refrigerant and corrode copper pipes.

In the event of a suspected leak, all open flames must be removed/ extinguished.

In the event that the refrigerant leak is found and requires hard soldering, then all the refrigerant must be drained from the system or separated (by closing a valve) in a part of the system distant from the leak. The system must then be cleaned out using oxygen-free nitrogen (OFN) both before as well as after the hard soldering process.

7. Collection and pump discharge

In the event that the cooling circuit is breached due to repairs – or for any other reason – conventional procedures must be followed. It is, however, important to adhere to the best method due to flammability. It is necessary to adhere to the following procedure:

- collect the refrigerant;
- clean out the circuit using inert gas;
- pump out;
- again clean out using inert gas;
- open the circuit by cutting or hard soldering.

The contents of the circuit must be collected into correct collection cylinders. The system must be “flooded” with OFN (oxygen-free nitrogen) for the unit to remain safe. It may be necessary to repeat the procedure several times. For this task, neither compressed air nor oxygen may be used.

Flooding may be achieved by disrupting the vacuum in the system with the use of OFN, and by continued filling until the operating pressure is achieved, then venting into the atmosphere and finally lowering to a vacuum. This process must be repeated if refrigerant still remains in the system. When the last OFN cartridge is used, the system must be ventilated to atmospheric pressure to enable work to be performed. This activity is absolutely necessary if hard soldering is to be performed on the pipes.

It is necessary to ensure that the vacuum pump outlets are not nearby to any ignition source, and ventilation must be provided.

8. Filling procedure

Apart from conventional filling procedures, also the following requirements must be adhered to.

- It is necessary to ensure that no contamination by various refrigerants occurs when the filling device is used. Hoses or pipes must be as short as possible to minimise the amount of refrigerant contained inside of them.
- Cylinders must be held vertically.
- It is important to ensure that the cooling system is grounded prior to being filled with refrigerant.
- When filling is complete, the system must be marked with a label (if it does not have one already).
- It is necessary to pay extreme care to ensure that the cooling system is not overfilled.

A pressure test using OFN must be performed before refilling the system. In the case of a leak, the system must be tested after being refilled but also before being put into operation. A verification test must be performed before leaving the installation location.

9. Taking out of operation

Prior to performing this procedure it is essential that the technician fully acquaints him/herself with the device and all its particulars. Correct practice of safely collecting all refrigerant is recommended. Prior to performing this activity, oil and refrigerant samples must be taken if an analysis is required prior to using the regenerated refrigerant for

the first time. It is essential that prior to starting this activity that electricity is available.

- a) Acquainting one's self with the device and its activity.
- b) Electrical disconnection of the system.
- c) Prior to starting the procedure, ensure that:
 - if required, mechanical device for handling the cylinder with refrigerant is available;
 - all personal protective devices are available and used correctly;
 - the collection process is constantly under the supervision of a competent person;
 - the collection device and cylinders comply with respective norms.
- d) Pump out the cooling system if possible.
- e) If achieving vacuum is not possible, collection pipes are created to enable the collection of refrigerant from various parts of the system.
- f) Ensure that the cylinder is placed on the scale before the collection of refrigerant is started.
- g) The collection device is turned on and runs according to the manufacturer's instructions.
- h) Cylinders are not overfilled. (No more than 80 % of liquid content capacity).
- i) The maximum operating pressure of the cylinder is not exceeded, even temporarily.
- j) When the cylinders are properly filled up and the procedure is complete, ensure that the cylinders and devices are immediately removed from the installation location and that all the separation valves on the device are closed.
- k) The collected refrigerant must not be filled into a different cooling system until it is cleaned and checked.

10. Marking with a label

- The appliance must be marked with a label indicating that it has been put out of operation and is without refrigerant. The label must be dated and signed. It is ensured that there are labels on the appliance indicating that it contains flammable refrigerant.

11. Collection

When the refrigerant is collected from the system, either due to servicing or when it is put out of operation, it is recommended to adhere to proper practice and safely collect all the refrigerant.

When the refrigerant is transferred into the cylinders, it is necessary to ensure that appropriate cylinders for collecting refrigerant are used.

It is necessary to ensure that there is a sufficient number of cylinders available to contain the complete contents of the system. All the cylinders that are to be used must be intended for collecting refrigerant and be marked with a label for this refrigerant (i.e. special cylinders for collecting refrigerant). The cylinders must be complete with a safety valve and associated closing valves in good working condition. The empty collection cylinders are pumped empty and if possible cooled prior to collecting refrigerant.

The collection device must be in good operating condition with a set of manuals relating to the device, which are on hand and it must be suitable for collecting flammable refrigerants. Apart from this, a set of calibrated scales in good operating condition must also be available. Hoses must be complete with couplers without seepage and in good condition. Prior to using the collection device, check that it is in satisfactory operating condition, has been properly maintained and all the associated electrical components are sealed to prevent ignition in the event of refrigerant being released. If in any doubt, consult the manufacturer.

The collected refrigerant must be returned to the refrigerant supplier in the correct collection cylinder and with a respectively arranged waste transport letter. Refrigerants are not to be mixed in the collection units and especially not in the cylinders.

In the event that compressors or compressor oils are to be collected, ensure that they are pumped out to an acceptable level in order to ensure that flammable refrigerant does not remain in the lubricant. The pump discharge process must be performed before the compressor is returned to the supplier. To speed up this process, only electrically heated compressor elements may be used. When the oil is drained from the system, it must be disposed of safely.

