

# SENCOR®

SRV 4550WH



ROBOTIC VACUUM CLEANER

Translation of the original manual



**SENCOR®**

**SRV 4550WH**



**A**

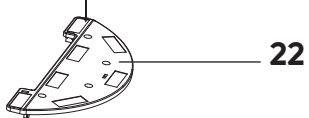
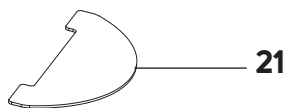
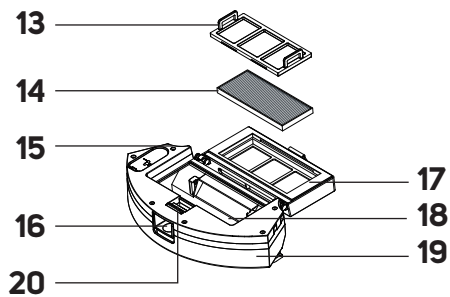
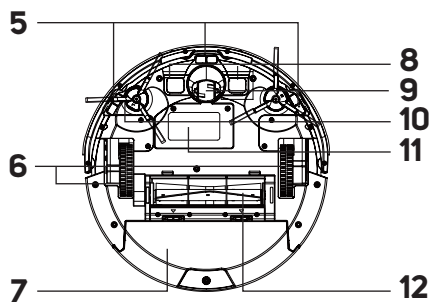
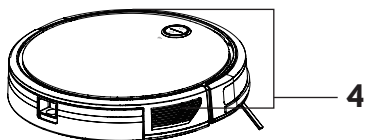
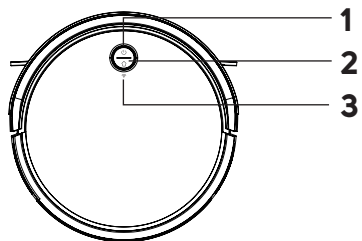

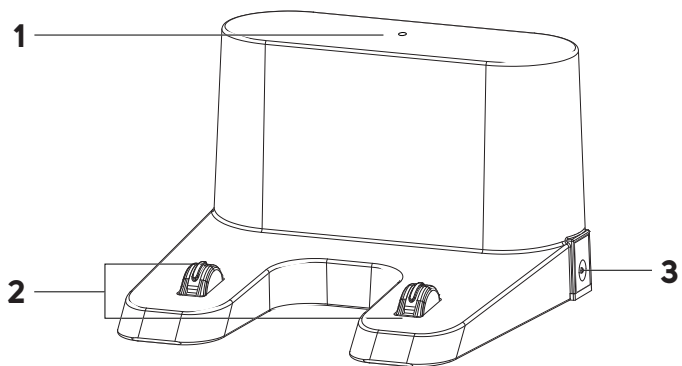
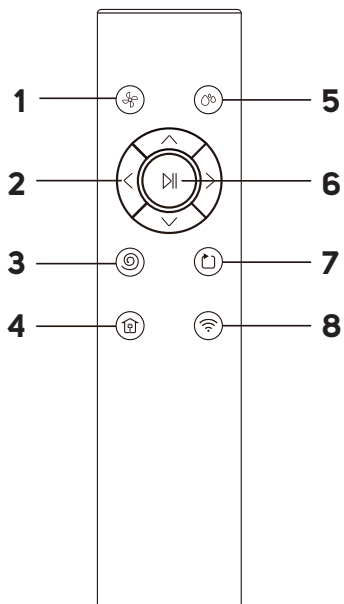
**B****C**

**D1**

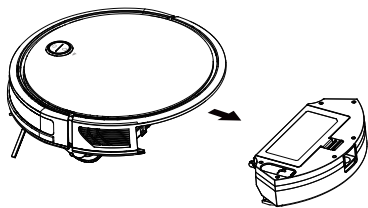

**D2**

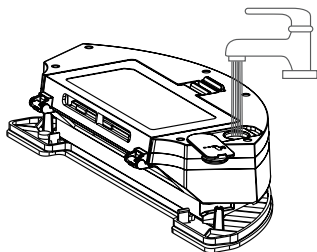

**D3**

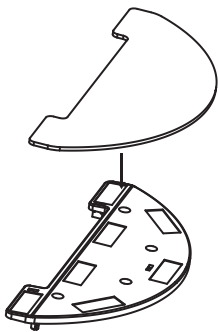

**D4**

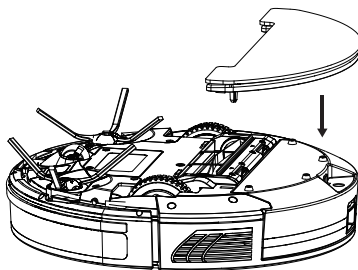

E

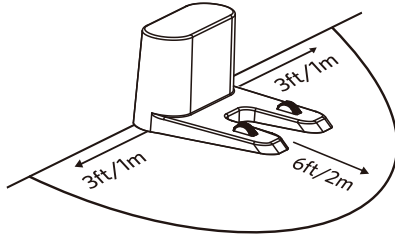

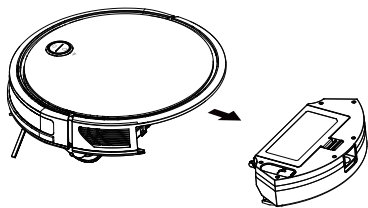
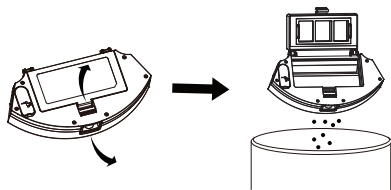
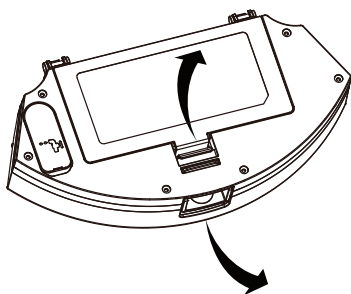
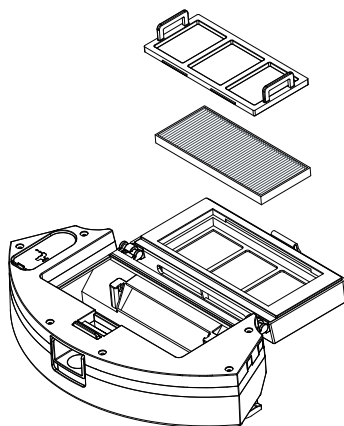
**F1****F2****F3****F4**

**G1**

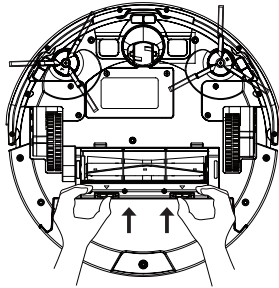

**G2**

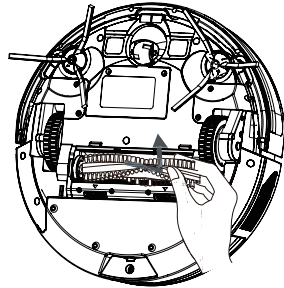

**G3**

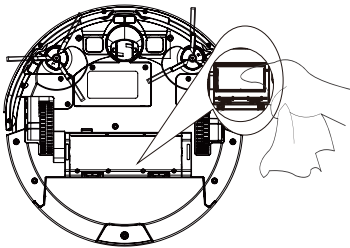

**G4**

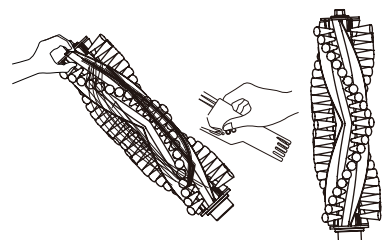



# EN Robotic Vacuum Cleaner

## Important Safety Instructions

### **READ CAREFULLY AND STORE IT FOR FUTURE USE.**

- This appliance may be used by children 8 years of age and older and by persons with physical, sensory or mental impairments or by inexperienced persons, if they are properly supervised or have been informed about how to use of the product in a safe manner and understand the potential dangers.
- Children must not play with the appliance. Cleaning and maintenance performed by the user must not be performed by unsupervised children.
- If the power adapter or charging station is damaged, have it replaced by a qualified service centre to avoid a dangerous situation. It is forbidden to use the appliance with a damaged power adapter or charging station.
- Prior to cleaning or maintenance, always disconnect the appliance from the power socket and turn it off using the power switch.
- The appliance must only be used with the charging station and power adapter supplied with the appliance.

## **WARNING:**

Do not use the charging station or power adapter to charge batteries or appliances that are not designed for this purpose. Connect the power adapter only to a power socket with a protective contact.

### **Electrical Safety**



- Before connecting the adapter to a power socket check that the technical details on the rating label match the electrical voltage in the socket.
- Connect the power adapter only to a properly grounded socket. Do not use an extension cord.
- Do not disconnect the power adapter from the socket by pulling on the power cord. This could damage the power adapter or the socket. Disconnect the power adapter from the power socket by pulling the plug.
- Do not lay the power adapter of the collection station over sharp objects. Make sure that the power cord does not hang over the edge of the table or touch a heated or hot surface.
- Keep the power adapter and its power cord dry.
- Do not connect or disconnect the power adapter to or from the power socket with wet hands.
- Do not uncover the electronic parts of the robotic vacuum cleaner or its battery. They do not contain any components repairable by the user. Have the appliance serviced by qualified persons.
- To prevent possible electric shock, do not spray the robotic vacuum cleaner, the power supply unit or the power adapter with water or immerse it in water or other liquids.
- Do not use the robotic vacuum cleaner when it is not working correctly, if it has been damaged or has been submerged in water.
- To avoid the danger of injury by electrical shock, do not repair the robotic vacuum cleaner yourself or make any adjustments to it. Have all repairs or adjustments performed at an authorised service centre. Tampering with the robotic vacuum cleaner during the warranty period may void the warranty.
- Prior to cleaning or maintenance, always disconnect the robotic vacuum cleaner from the power socket and turn it off using the power switch.

### **Safety in Use**

- This robotic vacuum cleaner is designed for use in households, offices and similar types of areas. Do not use it in industrial surroundings or outdoors.
- The robotic vacuum cleaner is not intended for vacuuming water and, therefore, must not be used in damp or wet areas, for example in laundries, bathrooms or around swimming pools. If it were to come into contact with water, the internal electronics of the vacuum cleaner would be destroyed. Do not use the robotic vacuum cleaner to vacuum the following items:
  - smouldering cigarettes, burning or flammable items, matches or ash;
  - water and other liquids;
  - sharp items, e.g. splinters, needles, pins, etc.;
  - flour, wall plaster and other building materials;
  - larger pieces of paper or plastic bags, which can easily block the suction opening.
- Do not expose the robotic vacuum cleaner to direct sunlight and do not place it near an open fire or appliances that are a source of heat.
- Do not use the robotic vacuum cleaner on narrow raised surfaces such as tables, wardrobes, etc. If the vacuum cleaner does not have sufficient space for manoeuvring, it may fall and be damaged.
- Only use the robotic vacuum cleaner with original accessories from the manufacturer.
- Ensure that the robotic vacuum cleaner has a dust filter correctly installed in the dust container before use.
- Before putting the robotic vacuum cleaner into operation, check that the entry door into your apartment or house is closed. From the floor surfaces remove clothing, paper, toys, power or extension cords and other items that the vacuum cleaner could suck in or catch. Lift curtains and drapes that reach to the floor so that they do not get caught in the vacuum cleaner.
- Do not place any items on to the robotic vacuum cleaner and do not step or sit on it.
- If the robotic vacuum cleaner is running, watch out for children and household pets.
- When the robotic vacuum cleaner is running, ensure that the air outlet openings are not covered and that the suction opening is not blocked. Otherwise, the robotic vacuum cleaner may be damaged.
- Follow the cleaning and maintenance instructions provided in this user's manual.

- Thank you for purchasing our SENCOR product; we hope you will be satisfied with it.
- Prior to using this appliance, please read the user's manual thoroughly, even in cases where owners have previously familiarised themselves with using similar types of appliances. Only use the appliance in the manner described in this user's manual. Keep the manual for future reference.
- It is recommended to keep the original shipping carton, packing material, receipt and confirmation of the extent of the seller's liability or warranty certificate at least for the duration of the legal right of defective performance or quality guarantee. When transporting the appliance, we recommend packaging it again in the original box provided by the manufacturer.
- The suction opening effectively removes hair, animal hair, etc. Side rotary brushes sweep dirt from hard-to-reach areas along walls and furniture and from corners. The motorised rubber wheels protect sensitive floors against scratching and can travel over threshold strips up to a height of 1.6 cm and ride on to a 1.6 cm high carpet.
- The suspended bumper enables the vacuum cleaner to dampen the approach to an obstacle and to efficiently clean around it. The infrared sensors in the front bumper prevent the robotic vacuum cleaner from colliding with obstacles. Safe operation in rooms with stairs is made possible by the bottom anti-stair-fall sensors.
- The remote control is used for convenient operation, which allows the vacuum cleaner to be switched on and off, put into automatic cleaning mode, select an operating mode or send the robotic vacuum cleaner to the charging station.
- The vacuum cleaner is equipped with GYRO MAPPING function (orientation in space), which can identify the space geometry of a room in which it is cleaning, thereby the vacuum cleaner is able to better clean the floor. This function is built-in and cannot be influenced in any way.







### DESCRIPTION OF THE ROBOTIC VACUUM CLEANER

- |   |  |
|---|--|
| <b>A1</b> Button  to switch on and interrupt automatic cleaning)             | <b>A10</b> Side rotary brushes           |
| <b>A2</b> Button  to send the robotic vacuum cleaner to the charging station | <b>A11</b> Battery (located under cover) |
| <b>A3</b> Wi-Fi indicator light   | <b>A12</b> Rotary brush                  |
| <b>A4</b> Infrared sensors  | <b>A13</b> Coarse filter                 |
| <b>A5</b> Anti-fall sensors   | <b>A14</b> HEPA filter                   |
| <b>A6</b> Travel wheels   | <b>A15</b> Water tank opening cover      |
| <b>A7</b> Combination 2-in-1 dust container with water tank   | <b>A16</b> Dust container release button |
| <b>A8</b> Charging contacts   | <b>A17</b> Dust container lid            |
| <b>A9</b> Front swivel wheel  | <b>A18</b> Dust container                |
|   | <b>A19</b> Water tank                    |
|   | <b>A20</b> Dust container lid lock       |
|   | <b>A21</b> Mop sleeve                    |
|   | <b>A22</b> Mop sleeve holder             |

### DESCRIPTION OF THE CHARGING STATION

- |                                |  |
|--------------------------------|--|
| <b>B1</b> Recharging indicator | <b>B3</b> Connector for adapter terminal |
| <b>B2</b> Charging contacts    |  |

### DESCRIPTION OF THE REMOTE CONTROL

- |  |   |
|--|---|
| <b>C1</b> Button  for setting the suction power   | <b>C5</b> Button  to start mopping mode                            |
| <b>C2</b> Directional buttons to move the vacuum cleaner forward/backward/left/right   | <b>C6</b> Button  to start automatic cleaning / interrupt cleaning |
| <b>C3</b> Button  to start local cleaning        | <b>C7</b> Button  to start cleaning along the walls                |
| <b>C4</b> Button  to return to charging station | <b>C8</b> Wi-Fi on/reset button                                  |

### INCLUDED CONTENTS

Robotic Vacuum Cleaner  
 Charging station  
 Remote control  
 Mop sleeve holder  
 Mop sleeve (3 pcs)  
 HEPA filter (2 pcs: 1 pc installed on the vacuum cleaner; 1 pc spare HEPA filter)  
 Side rotary brush (4 pcs: 2 pcs installed on the vacuum cleaner; 2 pc spare side rotary brushes)  
 Power adapter  
 Cleaning brush  
 AAA batteries for remote control (2 pcs)

### PURPOSE OF USE AND FEATURES OF THE ROBOTIC VACUUM CLEANER

- The robotic vacuum cleaner is intended for cleaning various types of hard floors such as wooden or laminate floating floors, tiles, vinyl, etc. and carpets with a low pile height. While vacuuming, it effectively combines various routes to optimally clean the entire floor area.

### ROBOTIC VACUUM CLEANER CLEANING MODES

#### Automatic Cleaning

This is the main program of the vacuum cleaner. This is a smart program that selects the most efficient route to vacuum the maximum area. When the vacuum is finished, it switches off and the vacuum cleaner finds the charging station and docks in it.

#### Local Cleaning Mode

The robotic vacuum cleaner will effectively clean an area about 1 m in diameter by vacuuming from a central point and spiralling outwards and then inwards back to the central point. This is a highly efficient cleaning of a certain area with increased suction power.

#### Cleaning Along the Wall Mode

The robotic vacuum cleaner will vacuum along the walls, furniture legs, etc.



#### Note:

Prior to starting the robotic vacuum cleaner, always check that it is fully charged and that all obstacles, foreign objects, cables, etc. have been removed from the area.

### PREPARING THE ROBOTIC VACUUM CLEANER

Take the robotic vacuum cleaner and all its accessories out of the packaging. Check that you have taken out all the parts. Check the robotic vacuum cleaner and its accessories for damage. Remove protective foils and advertising labels from the robotic vacuum cleaner and all accessories.

#### Installation of Side Rotary Brushes

The side rotary brushes are intended for smooth floor surfaces and ensure effective cleaning in corners, along walls and furniture.

Turn the vacuum cleaner upside down. Fit the rotary brushes on the pins intended for them and secure them with a screwdriver. Turn the vacuum cleaner back over.

When using the vacuum cleaner to clean rooms with carpets, remove the rotary brushes. To remove it, proceed in the reverse sequence.

#### COMBINATION 2-IN-1 DUST CONTAINER WITH WATER TANK

The combination dust container with water tank enables the floor to be vacuumed and wiped at the same time. The robotic vacuum cleaner vacuums dirt and dust from the floor and then wipes it. Depending on the intended use of the robotic vacuum cleaner, it is necessary to pour water into the water tank and to attach the holder with the mop sleeve.

### Using the Robotic Vacuum Cleaner Only for Vacuuming

1. When using the robotic vacuum cleaner only for vacuuming, before using it, ensure that the dust container is inserted in the vacuum cleaner and that it is empty.
2. In order to be able to remove the dust container, press the dust container release button and pull the dust container out of the vacuum cleaner – see figure **D1**.
3. Insert the dust container into the robotic vacuum cleaner so that the dust container lid is pointing upwards and the outlet is point outwards – see figure **D1**. Gently push down on the dust container from behind until you hear a click. This indicates that the dust container is correctly secured in the vacuum cleaner.

### Using the Robotic Vacuum Cleaner for Vacuuming and Wiping the Floor

In order to use the robotic vacuum cleaner for vacuuming and wiping the floor at the same time, it is necessary to put water into the water tank and to attach the holder with the mop sleeve on to the bottom side of the container.

1. Remove the dust container from the robotic vacuum cleaner by pressing the dust container release button and pull the dust container out of the vacuum cleaner – see figure **D1**.
2. Release the water tank cover and pour water into the water tank through the opening – see figure **D2**.



#### Note:

For wiping, we recommend using clean water. If you use a cleaning agent, it may foam up and thereby worsen the dripping of the water on to the sleeve, or potentially cause smudges on the floor after it dries.

1. Put the mop sleeve on to the holder – see figure **D3**. We recommend soaking and rinsing out the sleeve slightly before putting it on. This speeds up the soaking process and subsequent wiping of the floor.
2. Close the cover firmly and slide it into the robotic vacuum cleaner so that the dust container lid is pointing upwards and the outlet is point outwards – see figure **D1**. Gently push down on the dust container from behind until you hear a click. This indicates that the dust container is correctly secured in the vacuum cleaner.
3. Turn the robotic vacuum upside down and place the holder with the mop sleeve on the container so that the pins on the holder fit into the holes in the container – see figure **D4**. Push the holder down slightly until you hear a click. This indicates that the holder with the mop sleeve is correctly secured.



#### Warning:

Do not use the robotic vacuum cleaner to vacuum and wipe door mats, runners, etc. Before vacuuming carpets, it is necessary to remove the holder with the mop sleeve.

### LOCATION OF THE CHARGING STATION

- The charging station is used to automatically recharge the battery and the vacuum cleaner must have good access to it.
- Place the charging station against a wall on a hard, horizontal and dry surface within reach of the power socket – see Figure **E**. Ensure that there are no steps or obstacles within 1 m to the left and right and 2 m in front of the station that would prevent the vacuum cleaner from locating the charging station and docking successfully.
- Connect the power adapter cable connector to the socket on the charging station and plug the male plug of the adapter into a power socket. Position the power cord so that it will not get tangled in the rotary brushes of the vacuum cleaner.
- If you will not be using the vacuum cleaner for a long time, disconnect the charging station from the power socket and store it in a dry, clean and cool place.

### CHARGING THE ROBOTIC VACUUM CLEANER

- The vacuum cleaner can be charged in the charging station, which the vacuum cleaner automatically seeks out when it has finished cleaning.

#### Charging the Vacuum Cleaner for the First Time

- Before first use, it is necessary to fully charge the robotic vacuum cleaner. Allow the robotic vacuum cleaner to charge for up to 12 hours.

- Grasp the vacuum cleaner and manually place it into the charging station so that the charging contacts on the underside of the vacuum cleaner and the charging contacts on the charging station are connected. When the contacts are connected, the charging process will start.



#### Automatic Charging

- The robotic vacuum cleaner utilises the automatic charging function whenever it finishes cleaning and in cases, where during operation, it detects low power on the battery. The robotic vacuum cleaner starts actively searching for a charging station. It is thus important that it is always connected to a power source and is freely accessible for the vacuum cleaner so that it can dock in it.
- The robotic vacuum cleaner can be sent to be charged also by pressing the charging button on the remote control. In such a case, the operation of the robotic vacuum cleaner will stop and it will seek out the charging station.
- After docking in the charging station, the charging cycle will commence. A complete charge takes approximately 4 to 6 hours. The actual charging time depends on the power level of the battery at the start of the charging process.
- Full charge ensures up to 100 minutes of operation (low suction power set).
- In the event that the charging contacts are disconnected during the charging cycle, the vacuum cleaner will move away from the charging station and then re-dock itself to resume the charging process, unless it is prevented from doing so by an obstacle.
- In the event of a power outage, the charging cycle will be interrupted and will continue after the power supply is renewed.
- In the event that the maximum charging current is exceeded, the charging process will be automatically interrupted.
- If the robotic vacuum cleaner is completely discharged, e.g. due to the vacuum cleaner being unable to locate the charging station or dock in it, it must be manually positioned.

### CONTROLLING THE VACUUM CLEANER USING ITS BUTTON

- The buttons on the vacuum cleaner are used for basic controls. For advanced control, use the remote control or in-app control.

#### Turning the Robotic Vacuum Cleaner On/Off

- Press and hold down the button  for 3 seconds to turn on the robotic vacuum cleaner. The robotic vacuum cleaner will switch to the stand-by mode.
- Press and hold down the  button for 3 seconds to turn off the robotic vacuum cleaner.





#### Note:

It is not possible to turn off the robotic vacuum cleaner during the charging process.

#### Starting Automatic Cleaning

Press the  button to start automatic cleaning.

#### Pausing the Cleaning Process

If the  button is pressed during the operation of the robotic vacuum cleaner then the operation of the robotic vacuum cleaner will be paused. Pressing the  button again will resume its operation.

#### Sending to the Charging Station

If you need to send the robotic vacuum cleaner to the charging station, press the button  on the robotic vacuum cleaner. The robotic vacuum cleaner interrupts the cleaning and docks in the charging station.

### CONTROLLING THE VACUUM CLEANER USING THE REMOTE CONTROL

- Push down the latch of the cover on the rear side of the remote control to release it and remove the cover.
- Insert two type AAA (1.5 V) batteries into the remote control. When inserting the batteries ensure the correct polarity as shown inside the battery compartment. Put the cover back on and click it into place.
- In the event that the batteries are flat, replace them with new ones. Do not combine various types of batteries or new and old batteries.
- The signal range of the remote control is approximately 6 m.

- When replacing batteries, first remove the flat batteries and then insert the new ones.



**Note:**

Never combine flat and new batteries nor various types of batteries.

**Starting Cleaning**

- Press the button to start automatic cleaning.
- Press the button to start local cleaning.
- Press the button to start cleaning along the walls.
- The robotic vacuum cleaner will start and begin vacuuming. After finishing the cleaning, the vacuum cleaner will turn off and the vacuum cleaner will search for the charging station and dock in it to recharge.
- If the vacuum cleaner detects a low charge level during cleaning, it will interrupt cleaning and search for a charging station to recharge.

**Pausing the Cleaning Process**

- While the vacuum cleaner is running, press the button to stop its operation. Press the button again to resume operation.

**Manual Cleaning Stop**

- If you need to end the cleaning before it is complete, press the button , the robotic vacuum cleaner will stop, end the cleaning process, seek out the charging station and dock in it.

**Starting Mopping**

- Ensure that the holder with mop sleeve is attached to the vacuum cleaner and that there is water in the tank.
- Press the button and an audible alert sounds to indicate the mopping intensity (one press: low intensity; two presses: normal intensity; three presses: off). The mopping mode will turn on.
- If you press the button once more and no audible alert sounds, the mopping mode will end.

**Setting the Suction Power**

- Adjust the suction power according to the type of floor covering and the level of dirtiness.
- Press the button repeatedly to adjust the desired suction power from lowest to highest.

**Robotic Vacuum Cleaner Movement**

- The directional buttons are used to manually move the robotic vacuum cleaner. However, it is important that the robot vacuum cleaner is not in operation.
- The button is used to move forward.
- The button is used to turn the robotic vacuum cleaner by 180°.
- The button is used to turn the robotic vacuum cleaner by 90° to the left and move it to the left.
- The button is used to turn the robotic vacuum cleaner by 90° to the right and move it to the right.

**CONTROLLING THE VACUUM CLEANER USING THE MOBILE APPLICATION**

- The robotic vacuum cleaner can be controlled via the Sencor HOME application.
- Download the application to your smart phone, register yourself and control the robotic vacuum cleaner via the application.



If you already have the application installed, add the robotic vacuum cleaner to your devices. It is necessary that the location services for the Bluetooth function on the mobile phone are turned on.

**Adding the Robotic Vacuum Cleaner to the Device List via Bluetooth**

You can add the robotic vacuum cleaner to the Sencor HOME app by pairing via Bluetooth.

- Turn on the Bluetooth function on your mobile phone.
- Turn on the robotic vacuum cleaner.
- Open the app and on the app's home page, click the "+" icon.
- The device itself will offer the "Do not add / Go to add" options.
- Click on "Go to add" and the app will automatically guide you through the addition.



**Note:**

If the Bluetooth connection fails or is not possible, make sure there are no solid obstacles between your phone and the robotic vacuum cleaner and that the two devices are close together.

**Adding the Robotic Vacuum Cleaner to the Device List via a QR Code**

- The robotic vacuum cleaner can also be added to the Sencor HOME application using the QR code provided below. On the home screen of the application, click on the "+" icon and on the Add device screen, click on the [-] icon in the top right hand corner.
- After scanning the QR code, you will be prompted to select a Wi-Fi network. Select the network, enter your password and click "Next".
- You will be prompted to reset the device. Press and hold the and buttons on the robotic vacuum cleaner body for 5 seconds or the button on the remote control. The Wi-Fi indicator light is blinking. This means that the robotic vacuum cleaner is ready for pairing. Instructions can also be found on the application screen.
- In the app, confirm that the (Wi-Fi) light is flashing, then click "Next".
- Click on "Connect". Then in the Wi-Fi settings on your mobile device connect the Wi-Fi to the robotic vacuum cleaner. Then return to the application and wait until the pairing of the robotic vacuum cleaner is complete.
- In the device list on the main screen, click on the icon of the robotic vacuum cleaner to enter control interface.

**QR Code for Adding the Control Panel of the Robotic Vacuum Cleaner to the Application Sencor HOME**



**Manually Adding the Robotic Vacuum Cleaner to the Device List**

- In the upper right corner of the main screen, click "Add device" or "+", then click "Add device".
- A screen with appliance categories and a list of appliances will appear.
- Click on "Robotic vacuum cleaners" and from the list, select the robotic vacuum cleaner model.
- On the next screen, you will be prompted to select a Wi-Fi network. Select the network, enter your password and click "Next".
- You will be prompted to reset the device. Press and hold the and buttons on the robotic vacuum cleaner body for 5 seconds or the button on the remote control. The Wi-Fi indicator light is blinking. This means that the robotic vacuum cleaner is ready for pairing. Instructions can also be found on the application screen.
- In the app, confirm that the (Wi-Fi) light is flashing, then click "Next".
- Click on "Connect". Then in the Wi-Fi settings on your mobile device connect the Wi-Fi to the robotic vacuum cleaner. Then return to the application and wait until the pairing of the robotic vacuum cleaner is complete.
- In the device list on the main screen, click on the icon of the robotic vacuum cleaner to enter control interface.

**Wi-Fi Reset**

- Press and hold the and buttons on the robotic vacuum cleaner body for 5 seconds or the button on the remote control. The Wi-Fi indicator light is blinking.



**Note:**

We recommend that you turn off mobile data in your mobile phone settings when connecting to Wi-Fi.

## CLEANING AND MAINTENANCE

- Before cleaning, always turn off the vacuum cleaner with the  button.
- Never use abrasive cleaners, thinners, etc. for cleaning.
- Neglecting cleaning and maintenance may negatively affect the working order of the vacuum cleaner and lead to its reduced performance.

## ROBOTIC VACUUM CLEANER

### Emptying the Dust Container

1. In order to be able to remove the dust container, press the dust container release button – see Figure **F1**, and pull the dust container out of the vacuum cleaner.
2. Take the dust container over a garbage bin and turn it upside down so that the lid of the dust container points downwards.
3. Press the dust container lid release button and carefully tilt open the lid. Dump the contents of the dust container into the garbage bin – see figure **F2**.
4. Close the lid and gently push on it until you hear a click. This indicates that the lid is properly secured in place.



#### Note:

For hygiene reasons, we recommend emptying the container outside the living area.

### Cleaning the Dust Container

1. In order to be able to remove the dust container, press the dust container release button and pull the dust container out of the vacuum cleaner – see figures **F1**.
2. Press the dust container lid lock and tilt open the dust container lid – see figure **F3**.
3. Press the coarse filter lock. Take the coarse filter, foam filter and the HEPA filter out of the lid – see figure **F4**.
4. Tap out the HEPA filter and the foam filter and remove the dirt and dust from them using a fine brush or soft wiping cloth. In the event of heavy soiling, you can vacuum them out using a different vacuum cleaner with an attached brush nozzle. Do not wash the HEPA filter in water. This may damage the lid. In the event that the HEPA filter is already heavily soiled or deformed, replace it with a new one. We recommend replacing the HEPA filter based on the frequency of use at least once every six months.
5. Rinse the coarse filter under running water and wipe dry with a clean wiping cloth.
6. Wipe the dust container out using a lightly dampened sponge and wipe dry using a clean wiping cloth. If necessary, you can pour a small amount of water into the dust container and wipe it out with a sponge. Then thoroughly wipe it dry using a clean wiping cloth.
7. Insert the HEPA filter, the foam filter and then the coarse filter into the area in the lid. Gently push down on the coarse filter until you hear a click. This indicates that the coarse filter is properly secured in place.
8. Close the dust container lid. Gently push down on the lid until you hear a click. This indicates that the lid is properly closed.



#### Warning:

Prior to inserting the filter into the dust container and closing the lid, always ensure that all the parts are clean and completely dry. Otherwise, there is a risk of damaging the robotic vacuum cleaner.

### Cleaning the Water Tank and Mop Sleeve

To prevent the formation of moulds and damaging microorganisms that may cause unpleasant odours and be damaging to health, it is necessary to clean the water tank, mop sleeve holder and the mop sleeve after every use.

1. Carefully remove the mop sleeve holder from the dust container.
2. Carefully remove the mop sleeve from the holder.
3. In order to be able to remove the dust container, press the dust container release button and pull the dust container out of the vacuum cleaner.
4. Take the dust container over a wash basin or sink and release the water tank cover. Turn the container upside down and allow the water remaining in the water tank to flow out. If necessary, gently shake the water tank to ensure that all the water has flowed out.

5. Leave the water tank cover open and allow the water tank to dry out in a dry and well ventilated location.
6. Wipe the mop sleeve holder using a lightly dampened sponge and wipe dry using a clean wiping cloth.
7. Hand wash the mop sleeve in lukewarm water with a small amount of fine washing powder, wring it out by hand and allow it to dry naturally. Do not wash the mop sleeve in a washing machine or dry it in a clothes dryer.

### Cleaning the Central Rotary Brush

We recommend that you regularly clean the central rotary brush, at least once per week, to ensure the constant suction power of the robotic vacuum cleaner. Hair and fur that is wound on to the brush may reduce the output power output of the robotic vacuum cleaner and also its effectiveness.

1. Turn the robotic vacuum cleaner upside down.
2. Press the clip of the central rotary brush cover and take the cover off the vacuum cleaner – see figure **G1**; and then take out the rotary brush – see figure **G2**.
3. Use a dry wiping cloth to clean out the area in which the rotary brush is housed – see Figure **G3**. Check and clean out the suction hole. Dirt and dust that accumulates around the suction hole may reduce the suction power of the vacuum cleaner.
4. Remove any dirt and material (dust, wound on hair, animal fur, etc.) from the rotary brush – see picture **G4**.
5. Insert the rotary brush back into the vacuum cleaner and put on the cover. Gently push down on the cover until you hear a click. This indicates that the cover is properly secured in place.

### Cleaning the Side Rotary Brushes

1. Loosen the screw of the side rotary brush using a screwdriver.
2. Take the side rotary brush out of the vacuum cleaner by pulling it upwards.
3. Remove any dust and dirt from the location where the brush was mounted.
4. Remove all dust and dirt from the brush. If necessary you may wash the brush under running water. If the bristles were deformed while the vacuum cleaner was running, dip them in warm water to allow them to return to their original shape. Allow the brush to dry before reattaching to the vacuum cleaner.
5. Insert the side rotary brush into the robotic vacuum cleaner and secure with the screw.

### Cleaning the Sensors

- The sensors on the robotic vacuum cleaner are important for its proper control and safe operation. It is therefore important that you clean them regularly and keep them in good condition.
- Wipe the sensors using a soft dry wiping cloth or cotton bud.

### Cleaning the Outer Surface of the Robotic Vacuum Cleaner

- Regularly wipe the surface of the vacuum cleaner using a soft dry wiping cloth.
- Clean the front swivel wheel, motorised wheels, suction hole, rotary brush and the bottom sensors at least once per week or more frequently.
- First remove any coarser dirt from the front swivel wheel and the motorised wheels. Then clean them around their entire perimeter using a lightly dampened cloth and wipe them dry. Do not forget to also clean the area around the wheels.

### Replacing the HEPA and Foam Filter

1. Take out the dust container and open the dust container lid. Take out the coarse filter, old foam filter and old HEPA filter.
2. Insert a new HEPA filter, a new foam filter and then the coarse filter into the area in the lid. Gently push down on the coarse filter until you hear a click. This indicates that the coarse filter is properly secured in place.
3. Close the dust container lid. Gently push down on the lid until you hear a click. This indicates that the lid is properly closed.



#### Note:

The HEPA and foam filters are always replaced at the same time.

### Replacing the Side Brush

The rotary brushes become worn out when used. After a certain time it is necessary to replace the used brushes with new ones. To order a new brush, please contact your vendor or an authorised service centre.

1. Loosen the screw of the side rotary brush using a screwdriver.
2. Take the old side rotary brush out of the vacuum cleaner by pulling it upwards.
3. Insert the new side rotary brush into the robotic vacuum cleaner and secure with the screw.

.....

## **CLEANING THE CHARGING STATION**

### **Cleaning the Charging Station**

Clean the outer surface of the collection station using a soft dry cloth.

### **Cleaning the Sensors**

- The sensors on the charging station are important for its operation. It is therefore important that you clean them regularly and keep them in good condition.
- Wipe the infrared sensors and charging contacts with a dry soft cloth or cotton swab.

.....

## **REPLACING THE BATTERY**

Replacement battery model number: SRX 3101

In the event that you need to replace the battery, proceed as follows:

1. Make sure that the vacuum cleaner is turned off using the  button. Turn the vacuum cleaner upside down.
2. Using a screwdriver, loosen the screws of the battery cover, remove it and carefully remove the battery.
3. Disconnect the battery connector and remove the battery from the inside of the vacuum cleaner.
4. Connect the new battery and insert it into the internal area. The battery can only be connected in one way. The connector is coded and cannot be turned around.
5. Put on the bottom cover and secure it in place using the screws. Turn the vacuum cleaner back to the operating position.
6. Place the vacuum cleaner into the charging station and allow the battery to charge to full capacity.



### **Note:**

The robotic vacuum cleaner is supplied with the battery already inserted.

.....

## **LONG-TERM STORAGE**

- When not using the vacuum cleaner for an extended period of time, do the following:
  - Clean the vacuum cleaner as described in chapter CLEANING AND MAINTENANCE.
  - Disconnect the collection station from the power socket. Store the vacuum cleaner with all its accessories in a dry, clean and cool place.
  - It is recommended to charge the vacuum cleaner every 3 months as this will extend the lifetime of the built-in battery.
  - Remove the battery from the remote control.
- .....

## TROUBLESHOOTING

Problem	Cause	Solution
The vacuum cleaner is not charging itself.	The charging contacts are not touching.	Check that the contacts are touching when inserting the vacuum cleaner into the charging station.
	The charging station is disconnected from the power source.	Insert the power adapter into a power socket and keep the charging station permanently connected.
The vacuum cleaner is stuck in a single location.	The vacuum cleaner has become entangled in wires/cables lying on the ground, in curtains or other foreign objects on the carpet.	The vacuum cleaner will always attempt to free itself on its own, however, we recommend to remove it by hand from the stuck location.
The vacuum cleaner returned to the charging station without completing the cleaning process.	The vacuum cleaner detected a low battery charge level and automatically returned to the charging station to recharge.	This is normal. Allow the vacuum cleaner to recharge.
The remote control doesn't work. (Recommended distance is 5 m.)	Batteries are flat.	Replace the batteries in the remote control.
	The vacuum cleaner battery is almost flat.	Allow the vacuum cleaner to recharge.
	The remote signal receiver on the vacuum cleaner or the signal transmitter on the remote control is blocked or soiled.	Wipe the signal receiver and transmitter using a clean wiping cloth.
	The remote control signal is being interfered with by another device in its vicinity.	Do not use the remote control in the vicinity of devices with an infrared signal.
Whilst the vacuum cleaner is running, vacuuming locations are being left out, its travel path is chaotic, it is travelling in the opposite direction or seems to vacuum the same places over and over again.	The floor is too smooth, the central wheel slides on the floor, the vacuum cleaner is on a carpet with too high a pile, or the vacuum cleaner travels over low obstacles, thresholds and strips, and this affects its decision making process regarding the cleaning area in the entire home.	We recommend closing the doors of individual rooms and to allow them to be cleaned individually. The vacuum cleaner is equipped with a function for the identification of a single room. It will return to its starting location.
	The floor is washed and polished or too smooth, which reduces friction between the wheels and the floor.	We recommend cleaning the floor after it has been waxed.
	Cables, foreign objects on the floor affect the operation of the vacuum cleaner.	Prior to starting the vacuum cleaner, it is important to remove from the floor any cables, slippers, toys and other foreign objects to reduce the number of obstacles, which the vacuum cleaner will need to drive around.
Dirt remains on the floor after cleaning is finished.	The central rotary brush is blocked.	Clean out the central rotary brush and move the robotic vacuum cleaner into an open area.
	The side rotary brush is blocked.	Clean out the side rotary brush and move the robotic vacuum cleaner into an open area.
	The combination 2-in-1 dust container is not correctly inserted in the robotic vacuum cleaner.	Insert the combination 2-in-1 dust container into the robotic vacuum cleaner.
	The dust container is full, the HEPA filter is clogged or the central rotary brush is dirty.	Empty out the dust container, clean the HEPA filter and the central rotary brush.
It is not possible to turn on the vacuum cleaner.	The battery is flat.	Allow the battery to fully recharge.
The vacuum cleaner has problems with movement on the floor.	Front swivel wheel is blocked.	Clean out the front swivel wheel and move the robotic vacuum cleaner into an open area.
The vacuum cleaner will seek out the charging station but does not dock in it.	The charging station is blocked or is too far away, it is not connected to a power source; foreign objects are caught on the mop sleeve holder or the mop sleeve is rolled up.	Place the charging station into an open area and place the robotic vacuum cleaner into its vicinity and turn it on; insert the plug of the power adapter into a power socket; clean out the mop sleeve holder and straighten out the mop sleeve.
The vacuum cleaner is not behaving normally.	Internal fault.	Turn off the robotic vacuum cleaner and then turn it on again and start it. If the problem persists, turn off the vacuum cleaner and contact an authorised service centre.
Abnormal sounds are made during the cleaning process.	A foreign object has become stuck to the central rotary brush, side rotary brush or on the central swivel wheel.	Turn off the robotic vacuum cleaner and remove the foreign object.
The water tank does not release water into the sleeve or is only releasing a small amount of water.	There is an insufficient amount of water in the water tank; the sleeve is excessively soiled; the holder is not inserted.	Refill the water tank with water; clean the sleeve; correctly insert the mop sleeve holder.
The water tank is releasing too much water.	The water tank is not in its place; the water outlet is set to maximum.	Check that the water tank is properly inserted; adjust the water outlet.



## ERROR MESSAGES

LED indicator		Meaning	Solution
Red light.	One beep	Side travel wheel is blocked.	Eliminate the cause of the blockage.
	Two beeps	The side rotary brush is blocked.	Eliminate the cause of the blockage.
	Three beeps	The suction opening is blocked by a foreign object.	Clean the suction opening.
	Four beeps	The rotary brush is blocked.	Eliminate the cause of the blockage.
Red flashing.	Two beeps	The bumper is blocked.	Eliminate the cause of the blockage. Push your hand on the right, left and center of the bumper to make sure it is working properly.
	Three beeps	The sensors are dirty or the vacuum cleaner is placed on a dark floor or in a dark room.	Clean the sensors, move the vacuum cleaner to a lighter floor or a more lighted room.
	Four beeps	Low battery.	Allow the vacuum cleaner to recharge.

## TECHNICAL SPECIFICATIONS

### Robotic Vacuum Cleaner

Power input of the robotic vacuum cleaner.....	15 V DC current 0.8 A
Rated power.....	28 W
Battery.....	Li-ion / 10,8 V / 2 600 mAh
Dimensions (diameter x height).....	306 x 73.5 mm
Weight.....	2.5 kg
Operating time per single charge.....	100 min
Dust container capacity.....	250 ml
Water tank capacity.....	200 ml

### Power adapter

Rated voltage range.....	100–240 V~
Rated frequency.....	50–60 Hz
Output.....	15 V DC current 0.8 A

### Charging station

Input voltage.....	15 V DC current 0.8 A
Output voltage.....	15 V DC current 0.8 A
Rated power.....	15 W
Dimensions.....	146 x 131 x 75 mm

Name of manufacturer	FAST ČR, a.s. U Sanitasu 1621 CZ-251 01 Říčany
Model identification number	Power adapter for SRV 4550WH
Input voltage	100–240 V~
Input frequency	50–60 Hz
Output voltage	15 V
Output current	0.8 A
Output power	12 W
No load power consumption	0.131 W

Amendments to text and technical parameters are reserved.

### Original Consumable Accessories

SRX 3104	HEPA filter
SRX 3103	Side rotary brush
SRX 3102	Mop sleeve



The product is intended for household use only. The product is not intended for outdoor use.



Safety Class for Electric Shock Protection:  
Class II – Electric shock protection is provided by double or heavy-duty insulation.



This symbol indicates that the appliance must not be used if the power plug is damaged.

### DISPOSAL OF THE BATTERY



Prior to disposing of the product or handing it over at a specialised collection facility, it is necessary to ensure that the battery is removed. Before removing the battery, it is necessary to start the curling iron and wait until it is completely flat. The battery contains environmentally damaging compounds and therefore does not belong in standard household waste. Its proper disposal shall be ensured by the relevant collection point.

### DISPOSAL OF USED BATTERIES



Batteries contain environmentally damaging compounds and therefore do not belong in standard municipal waste. Take used batteries for proper disposal at a designated battery collection point.

SENCOR hereby declares that the radio device type SRV 4550WH conforms to the 2014/53/EU directive. The full text of the EU Declaration of Conformity is available at: [www.sencor.eu](http://www.sencor.eu).

