

SENCOR®

SAC MT7048C
SAC MT7049C



MOBILE WI-FI AIR CONDITIONER

Translation of the original manual



SENCOR®

**SAC MT7048C
SAC MT7049C**



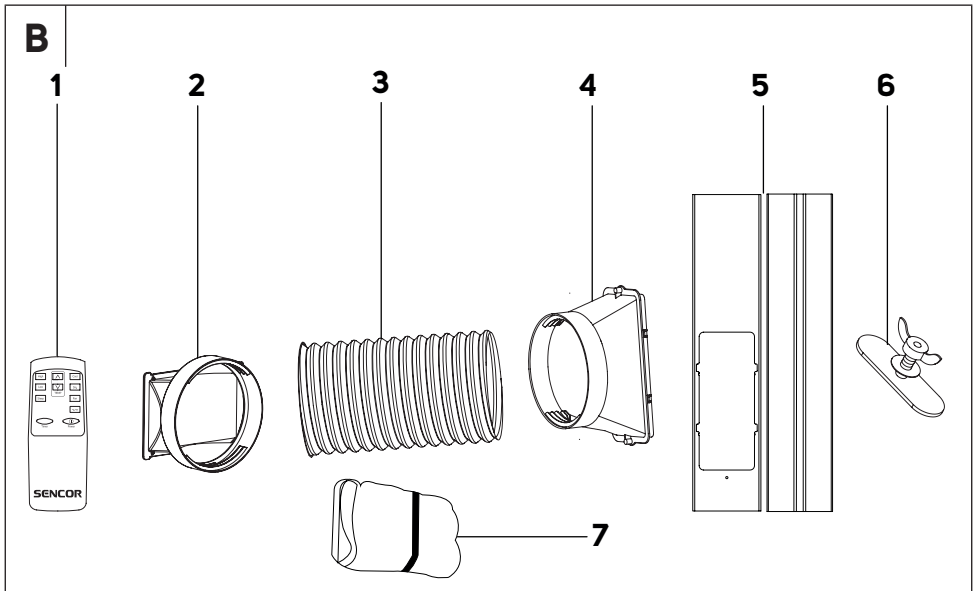
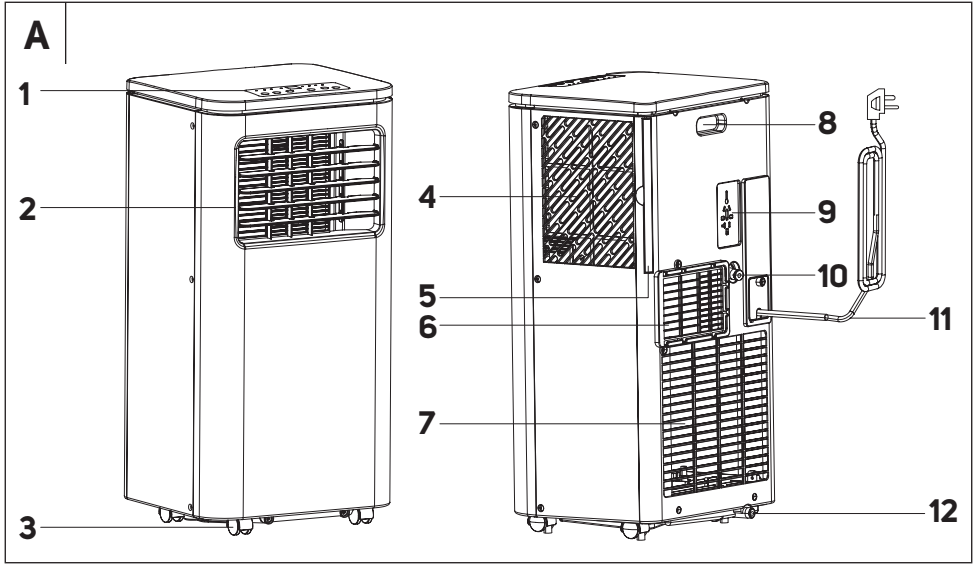

C

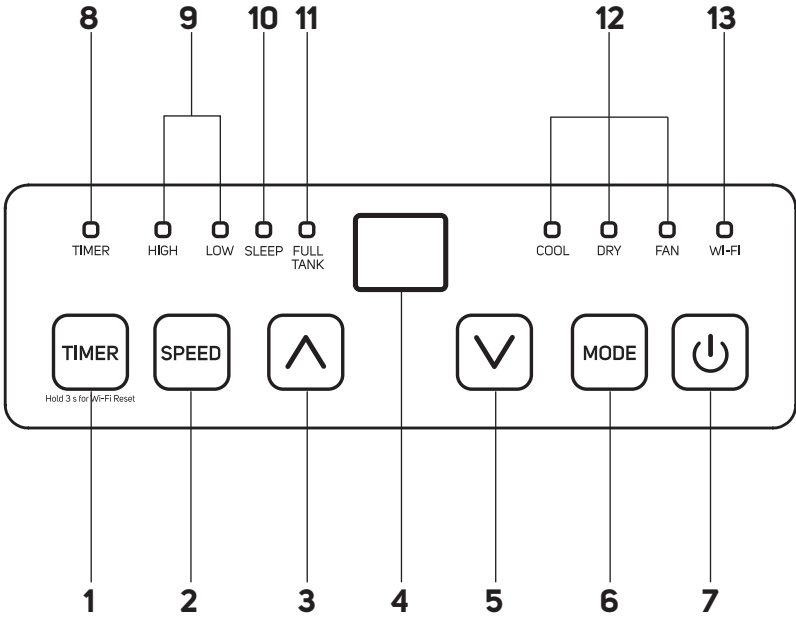

D

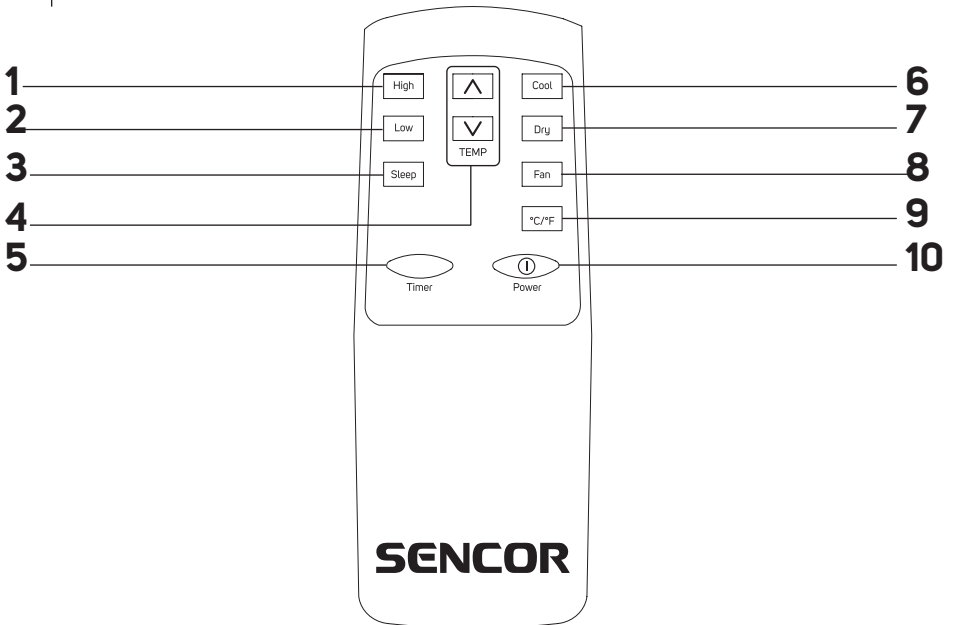

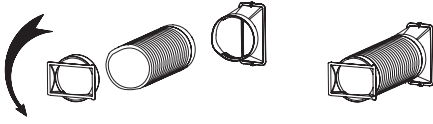
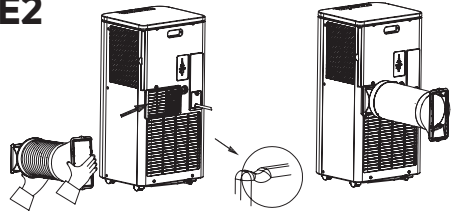
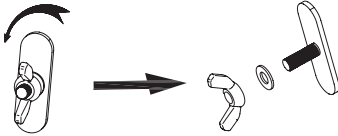
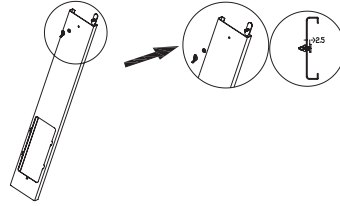
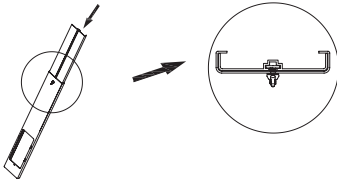
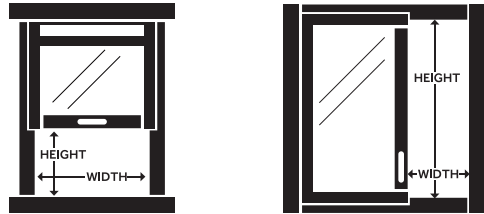
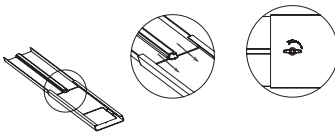
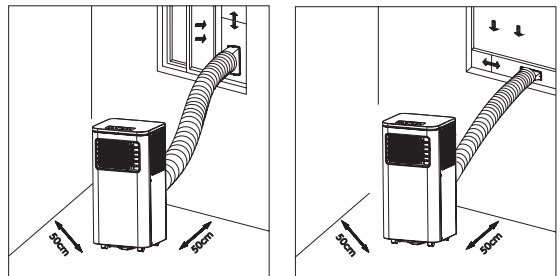
E1**E2****F1****F2****F3****F4****F5****F6**

G1

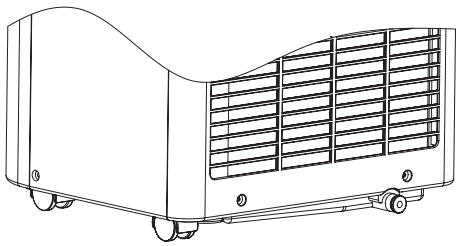

G2

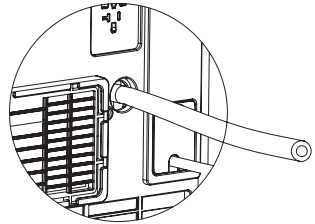

H

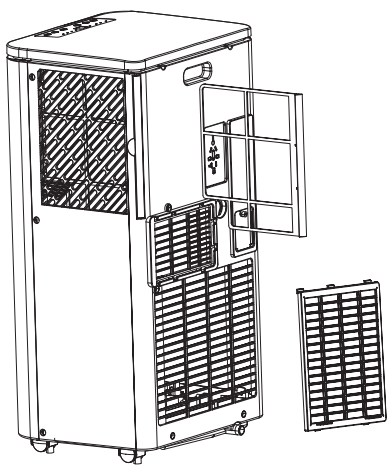

EN Mobile Wi-Fi Air Conditioner

Important safety instructions

READ CAREFULLY AND STORE FOR FUTURE USE.



This symbol indicates that not adhering to instructions may result in death or serious injuries.



WARNING:

To prevent death and injury to the user or other persons and the damage of property, the following instructions must be adhered to. Incorrect use as a result of not adhering to instructions may cause death, injuries or damage.

- This appliance may be used by children 8 years of age and older and by persons with physical, sensory or mental impairments or by inexperienced persons, if they are properly supervised or have been informed about how to use the product in a safe manner and understand the potential dangers. Cleaning and maintenance performed by the user must not be performed by unsupervised children. Children must not play with the appliance.
- If the power cord is damaged, it must be replaced by an authorised service centre or by another similarly qualified person, this will prevent the creation of a dangerous situation. It is forbidden to use the appliance if it has a damaged power cord.

- The appliance must be stored in a manner that prevents its mechanical damage.
- The appliance must be stored in a well ventilated location where the dimensions of the room correspond to the dimensions specified for its operation.
- The appliance must be stored in a room where an open flame is not continuously in use (e.g. running gas appliance) or where there are sources of ignition (e.g. running electrical heating element).
- Before connecting the appliance to a power socket, check that the rated voltage on its rating label matches the electrical voltage in the power socket.
- Connect the appliance only to a properly grounded socket.
- The power socket must be freely accessible so that it is possible to quickly disconnect the power cord from the power source if necessary.
- The appliance is designed for use at home, in offices and similar types of areas. Do not use it in very dusty or humid rooms such as laundries or bathrooms, in areas where chemical or explosive substances are stored, in industrial surroundings or outdoors!
- Do not place the appliance in the vicinity of an open flame or appliances that are sources of heat.
- Do not place the appliance on unstable surfaces such as carpets with very long and thick fibres.
- The appliance may only be used on a dry, stable, smooth and horizontal surface.
- The appliance is equipped with travel wheels, so pay extra attention when handling it so that it does not fall

down stairs or travel down from sloped areas. If necessary secure the wheels using the stoppers.

- Only use original parts to assemble the appliance. Before starting to assemble the appliance, make sure that it is turned off and disconnected from the power socket.
- Prior to connecting the appliance to a power socket, make sure that the appliance is correctly assembled according to the instructions in this user's manual.
- Do not touch the appliance with wet or damp hands. This applies especially when it is connected to a power socket.
- Do not expose the appliance to dripping or spraying water or submerge it in water or another liquid.
- Do not cover or insert anything into the air inlet or air outlet openings. Otherwise, this could damage the appliance.
- During operation there needs to be sufficient space for air circulation of at least 50 cm on all sides of the appliance.
- Do not expose yourself to a cold air current for a long time. This could have a negative effect on your health.
- To turn the appliance on or off, always use the appropriate buttons on the control panel or the remote control. Do not turn off the appliance by disconnecting the power cord from the power socket.
- Always turn off the appliance and disconnect it from the power socket when leaving it without supervision, when not using it and before moving, disassembling or cleaning it.
- Do not attempt to remove the outer case of the appliance.

- Disconnect the appliance from the power socket by pulling on the plug, never pulling on the power cord. Otherwise, this could damage the power cord or the socket.
- In the event that the power cord or power plug are damaged in any way, do not use the appliance.
- Store the appliance in a vertical position. It may be transported in a vertical position or tilted on the side. If you have already used the appliance, check that all the condensate has been drained. After transporting it, wait at least 1 hour before using the appliance.
- Do not use the appliance if it is not working correctly, if it has been damaged or has been submerged in water. To avoid a hazardous situation arising, do not repair the appliance yourself or modify it in any way. Have all repairs performed at an authorised service centre. By tampering with the appliance, you risk voiding your legal rights arising from unsatisfactory performance or quality warranty.
- Installation must be performed in accordance with the installation instructions. Incorrect installation may result in a water leak, injury by electrical shock or fire.
- To prevent the risk of fire or injury by electrical shock, do not use this appliance with a timer or any other similar device that could spontaneously start this appliance.
- The appliance must be installed in accordance with national electrical codes.
- Only use this product for the purposes that are described in this user's manual. Otherwise, this may result in damage or excessive noise and vibrations.

- Use only the accessories and components that are supplied together with the appliance and the tools explicitly intended for its installation. The use of non-standard parts and accessories may result in a water leak, injury by electrical shock, fire, injury or damage to property.
- DO NOT ADJUST the length of the power cord of the unit and do not use an extension cord for its power supply.
- DO NOT CONNECT the unit to a power socket to which other electrical appliances are already connected. The incorrect selection of an electrical power supply may result in a fire or injury by electrical shock.
- Do not cover the cable with a carpet. Do not place carpets, fillets or any other floor coverings on the power cord. Do not locate the power cord underneath furniture or appliances. Lead the cable where nothing will ride over it and where nobody can trip over it. If this occurs, immediately disconnect the unit from the power socket.
- In the event that the unit is tipped over during use, turn it off and immediately disconnect it from the main power supply. Visually check that the unit has not been damaged in any way. In the event of any doubts that the unit has been damaged in any way, seek assistance from a technician or customer service.
- The power supply must be disconnected during a thunder storm to prevent damage to the appliance in the event of a lightning strike.
- Disconnect the power supply to the appliance if it makes a strange noise or if an odour or smoke is emitted.



Read this user's manual.



Warning:
Fire hazard.

SPECIFIC INFORMATION FOR APPLIANCES USING REFRIGERANT GAS R290

- Carefully study any warnings.
- For defrosting and cleaning, do not use any other tools than those recommended by the manufacturer.
- This appliance must be located in an environment that has no continuously running fire sources (for example an open fire, a gas appliance or electrical appliances).
- Do not drill into the appliance or burn it.
- Refrigerant gases may be odourless.
- This appliance must be located in rooms with an area greater than 6 m².
- This appliance contains approx. 125 g of refrigerant gas R290.
- R290 is a refrigerant gas that meets European environmental protection directives. Do not make holes into any part of the cooling circuit or drill into it.
- The room in which this appliance is installed, operated or stored must be such as to prevent the collection of potentially leaked refrigerants, that could be the cause of explosion or fire as a result of the refrigerant igniting

following the start up of electrical heaters, cookers or other sources of ignition.

- The appliance must be stored in such a manner that its mechanical damage is prevented.
- Persons working with or repairing cooling circuits must have appropriate authorisation issued by an authorised institution that certifies this person's competence to work with refrigerants in accordance with the specific assessment of the association for this sector.
- Maintenance tasks must be performed solely on the basis of the recommendations of this appliance's manufacturer. Maintenance and repair tasks that required the contribution of other qualified expert personnel may only be performed under the supervision of specialised experts in the flammable refrigerants sector.
- Check the rating label for the type of refrigerant gas used in your appliance.
- Do not cover the vents.
- Adhere to national codes relating to gas.

- Thank you for purchasing a SENCOR brand product and we hope that you will be happy with it.
- Prior to using this appliance, please read the user's manual thoroughly, even in cases, when one has already familiarised themselves with previous use of similar types of appliances. Only use the appliance in the manner described in this user's manual. Keep this user's manual in a safe place where it can be easily retrieved for future use.
- We recommend saving the original cardboard box, packaging material, purchase receipt and responsibility statement of the vendor or warranty card for at least the duration of the legal liability for unsatisfactory performance or quality. In the event of transportation, we recommend that you pack the appliance in the original box from the manufacturer.



DESCRIPTION OF THE APPLIANCE

A1 Control panel	A7 Bottom protective grille of the air inlet with filter
A2 Air outlet	A8 Handle
A3 Travel wheels	A9 Power cord storage compartment
A4 Side protective grille of the air inlet	A10 Top drain outlet
A5 Removable filter holder	A11 Power cord
A6 Air outlet for connection to a flexible hose	A12 Bottom drain outlet

DESCRIPTION OF ACCESSORIES

B1 Remote control	B4 Window connection adapter
B2 Adapter for connection to the air outlet	B5 Window insert
B3 Flexible air exhaust hose	B6 Wing nut
	B7 Textile window gasket seal

DESCRIPTION OF THE CONTROL PANEL

C1 TIMER button for setting the timer	C8 Timer indicator
C2 SPEED button for setting the fan speed	C9 Fan speed indicators (high/low)
C3 Button 	C10 Sleep mode indicator
C4 Numerical display	C11 Full tank indicator
C5 Button 	C12 Operating mode indicators (cooling/dehumidification/fan)
C6 MODE button for selecting an operating mode	C13 Wi-Fi indicator
C7 On/Off POWER button	

REMOTE CONTROL

D1 High speed button	D6 COOL button
D2 Low speed button	D7 DRY button
D3 SLEEP button for setting the sleep mode	D8 FAN button
D4 TEMP button	D9 °C/°F button
D5 TIMER button for setting the timer	D10 POWER button for turning on/off

INSTALLATION

Installation location for the mobile air conditioner

- Take the air conditioner out for the packaging and ensure that you have taken out all the parts and accessories. We recommend that the air conditioner is taken out of the packaging by two adult persons.
- Locate the mobile air conditioner on an even, dry and stable surface and within reach of a grounded power socket. Do not locate it on an

unstable or tilted surface from which the mobile air conditioner could ride off, fall off or be damaged or cause injury.

- The mobile air conditioner must be located in such a way that it is not exposed to direct sunlight.
- Ensure that there is no heat source (e.g. heating, mobile heaters, stove, etc.) in the vicinity of the location where the mobile air conditioner will be placed.
- For easier handling, the mobile air conditioner is equipped with travel wheels. Do not use the travel wheels when you need to move the air conditioner over carpets or similar surfaces. Avoid riding over objects.
- To achieve optimal efficiency, maintain a distance of at least 50 cm from the wall or other obstacles.
- Position the mobile air conditioner at a sufficient distance from curtains, drapes or blinds.
- Ensure that the drain hose is not touching anything.



Note:

Do not use the mobile air conditioner to cool a room where computer servers, etc. are located. Installation, adjustment, maintenance and repairs must only be performed by a qualified person.

Installing the flexible hose on to the mobile air conditioner

- The flexible hose must be connected to the mobile air conditioner and installed into a window in accordance with the operating modes that you wish to set. Install the flexible hose when you wish to select the operating modes: cooling or sleep. It is not necessary to install the flexible hose when you wish to select the fan or dehumidification mode.
 1. Extend the flexible hose to the required length.
 2. Put the adapter for connection to the air outlet on to one end of the flexible hose, and screw it on anticlockwise. Put the window mounting adapter on to the other end of the flexible hose and screw it in clockwise – see picture **E1**.
 3. Put the flexible hose on to the air outlet and insert it into the outlet – see figure **E2**.

Installing the flexible hose into a slide window

- The window insert is designed to be compatible with the majority of sliding windows (vertical and horizontal). Nevertheless, for certain types of slide windows it may be necessary to modify the installation procedure described below.
 1. Screw apart the wing nut – see figure **F1**.
 2. Insert the bolt from the underside of the main window insert panel, put on the washer and screw in the wing nut – see figure **F2**. However, do not fully tighten the nut, allow free space of about 2,5 cm.
 3. Insert the auxiliary panel into the window insert – see figure **F3**. While inserting the auxiliary panel, take care that the bottom part of the wing nut fits into the groove in the auxiliary panel.
 4. Set the required length/width of the window insert based on the size of the window into which it is installed – see figure **F4**. Tighten the wing nut to set the length of the window insert – see figure **F5**.
 5. Open the sliding window sash and insert the window insert into the opening.
 6. Carefully close the window sash. Use one hand to hold the window insert in place.
 7. Install the flexible hose with the adapter attached into the opening in the window insert – see figure **F6**.



Note:

If necessary, cut away a part of the window insert if the window is too small.

Installing the flexible hose using the textile gasket seal

- The textile gasket seal is suitable for tilt-open, sash and roof windows. The textile gasket seal is fitted with a Velcro zip tape to make its

installation in the window easier. Open the window and into the created crevice install the textile gasket seal. We recommend that you thoroughly degrease the location where you will be attaching the textile gasket seal using an appropriate cleaning agent. Remove the protective paper strip and stick the tape on to the window frame.

- In order to be able to insert the flexible hose, the gasket seal is fitted with an integrated zip. Open the zip in such a location that will enable you to easily insert the flexible hose.
- It is not necessary to remove the textile gasket seal from the window when not using the mobile air conditioner. The window can be closed even with the gasket seal installed.



Note:

Avoid excessively bending the hose during the installation. To ensure proper operation of the mobile air conditioner, it is important not to overload the hose or to bend it unnecessarily. Excessive loading or bending may damage the hose.

PUTTING INTO OPERATION

- Ensure that the mobile air conditioner is correctly assembled and that the flexible hose is properly attached according to the above instructions.
- Ensure that the mobile air conditioner is located in a suitable location at a sufficient distance from the power socket.
- Insert the power plug into a properly grounded power socket.
- The mobile air conditioner will switch to the stand-by mode.

CONTROLS OF THE MOBILE AIR CONDITIONER

A. CONTROL PANEL

Turning the mobile air conditioner on/off

- Short press the **POWER** button and the mobile air conditioner will turn on and start running in the default setting.
- Repeatedly pressing the **POWER** button will turn off the mobile air conditioner and set it to the stand-by mode. To completely turn off the air conditioner, disconnect the power plug from the power socket.



Warning:

Do not turn on the mobile air conditioner immediately after turning it off. Wait several minutes before turning it on again. Otherwise, this could damage the compressor.



Note:

Never turn off the mobile air conditioner by pulling the power cord out of the power socket. Turn off the mobile air conditioner using button **POWER**, wait a few minutes and then pull out the power cord.

OPERATING MODES

1. Cooling mode

- Repeatedly press the **MODE** button until the **COOL** indicator is lit on the control panel.
- Use buttons  to set the desired temperature. You can set the temperature in the range from 17 to 30 °C.
- Use the **SPEED** button to set the fan speed. Repeatedly press the **SPEED** button to switch the speed in the following order: High (high speed) – Low (low speed). Each time the button is pressed, the respective indicator will be lit on the control panel.

2. Dehumidification mode

- Repeatedly press the **MODE** button until the **DRY** indicator is lit on the control panel.
- In this mode, the humidity in the room is reduced. Condensed humidity is accumulated in the tank. The methods for draining the

condensate are described in chapter **"DRAINING CONDENSATE"** in another part of the manual.

- It is not possible to set the temperature or fan speed in this mode. The fan speed is automatically set to low speed.

3. Fan mode

- Repeatedly press the **MODE** button until the **FAN** indicator is lit on the control panel.
- In this mode, the fan will ensure air circulation in the room but the unit will not cool down the room.
- Use the **FAN** button to set the fan speed. Repeatedly press the **FAN** button to switch the speed in the following order: High (high speed) – Low (low speed). Each time the button is pressed, the respective indicator will be lit on the control panel.

FUNCTIONS OF THE MOBILE AIR CONDITIONER

1. Timer functions

- The mobile air conditioner enables to timer settings – On timer and Off timer for the mobile air conditioner.

a) On timer for the mobile air conditioner

- The On timer for the mobile air conditioner enables the mobile air conditioner to be turned on after the set time has elapsed.
- While the mobile air conditioner is in the stand-by mode, press the **TIMER** button. The numerical display will start flashing and the timer indicator will be lit.
- Use buttons  to set the time after which the mobile air conditioner should turn on. The time can be set in the range from 1 to 24 hours, in 1 hour increments.
- Wait approximately 5 seconds until the time is saved to memory. Then the automatic countdown of the set time will commence.
- When the set time elapses, the mobile air conditioner will start in the last set operating mode.

b) Off timer for the mobile air conditioner

- The Off timer for the mobile air conditioner enables the mobile air conditioner to be turned off after the set time has elapsed.
- While the mobile air conditioner is turned on, press the **TIMER** button. The numerical display will start flashing and the timer indicator will be lit.
- Use buttons  to set the time after which the mobile air conditioner should turn off. The time can be set in the range from 1 to 24 hours, in 1 hour increments.
- Wait approximately 5 seconds until the time is saved to memory. Then the automatic countdown of the set time will commence.
- When the set time has elapsed, the mobile air conditioner will turn off and switch to the stand-by mode.
- If you need to cancel the timer, press the **TIMER** button. The remaining countdown time will start flashing. Press the **TIMER** button again and the timer will be cancelled.

2. Sleep function

- The sleep function is used to reduce overnight power consumption, when a constant temperature is not necessary. The function also ensures comfort during sleep since the operation of the air conditioner is quieter and the illumination of the display is dimmed.
- Select a cooling mode and set the default temperature. Then press both the **TIMER** and the  button at the same time, to activate the sleep function.
- The fan speed is automatically set to low speed.
- The sleep function cannot be set in the fan and dehumidification modes.

B. REMOTE CONTROL

Inserting and replacing batteries

- Slide out the battery compartment cover, which is located on the rear side of the remote control. Place two AAA/LR03 (2x 1.5V) alkaline batteries into the battery compartment and close the cover.
- When inserting the batteries ensure the correct polarity as shown in the battery compartment.

- When replacing the batteries, always use batteries of the same type, never combine old and new batteries or batteries of various types.



Note:

Removing the batteries from the remote control will delete all the settings. After new batteries are inserted the default remote control settings as programmed by the manufacturer will be renewed.

When not using the remote control for longer than 2 months, remove the batteries.



Attention:

Dispose of used batteries in accordance with valid local codes. Do not throw batteries out with communal waste. Do not use old and new batteries at the same time. Do not use alkaline, standard or rechargeable batteries in combination at the same time. Do not throw batteries into a fire. They could explode or electrolyte could leak out.

Using the remote control

- For the remote control to work correctly, ensure that the maximum distance of the remote control from the mobile air conditioner is not greater than 8 m and that there is no obstacle between the remote control and the mobile air conditioner that could prevent the transmission of the signal.
- Point the remote control directly at the mobile air conditioner. The transmission of the signal is confirmed by a short sound signal.
- Do not expose the remote control to direct sunlight or high temperatures. Otherwise the signal may not be transmitted.

Turning the mobile air conditioner on/off

- Short press the **POWER** button and the mobile air conditioner will turn on and start running in the default setting.
- Repeatedly pressing the **POWER** button will turn off the mobile air conditioner and set it to the stand-by mode. To completely turn off the air conditioner, disconnect the power plug from the power socket.



Warning:

Do not turn on the mobile air conditioner immediately after turning it off. Wait several minutes before turning it on again. Otherwise, this could damage the compressor.



Note:

Never turn off the mobile air conditioner by pulling the power cord out of the power socket. Turn off the mobile air conditioner using button **POWER**, wait a few minutes and then pull out the power cord.

OPERATING MODES

1. Cooling mode

- Press the **COOL** button.
- Use the buttons ▲/▼ to set the desired temperature. You can set the temperature in the range from 17 to 30 °C.
- Use the HIGH/LOW buttons to set the fan speed, with HIGH for high speed and LOW for low speed.

2. Dehumidification mode

- Press the **DRY** button.
- In this mode, the humidity in the room is reduced. Condensed humidity is accumulated in the tank. The methods for draining the condensate are described in chapter "DRAINING CONDENSATE" in another part of the manual.
- It is not possible to set the temperature or fan speed in this mode. The fan speed is automatically set to low speed.

3. Fan mode

- Press the **FAN** button.
- In this mode, the fan will ensure air circulation in the room but the unit will not cool down the room.

- Use the **HIGH/LOW** buttons to set the fan speed, with **HIGH** for high speed and **LOW** for low speed.

FUNCTIONS OF THE MOBILE AIR CONDITIONER

1. Timer functions

- The mobile air conditioner enables to timer settings – On timer and Off timer for the mobile air conditioner.

a) On timer for the mobile air conditioner

- The On timer for the mobile air conditioner enables the mobile air conditioner to be turned on after the set time has elapsed.
- While the mobile air conditioner is in the stand-by mode, press the **TIMER** button. The numerical display will start flashing and the timer indicator will be lit.
- Use buttons ▲/▼ to set the time after which the mobile air conditioner should turn on. The time can be set in the range from 1 to 24 hours, in 1 hour increments.
- Wait approximately 5 seconds until the time is saved to memory. Then the automatic countdown of the set time will commence.
- When the set time elapses, the mobile air conditioner will start in the last set operating mode.

b) Off timer for the mobile air conditioner

- The Off timer for the mobile air conditioner enables the mobile air conditioner to be turned off after the set time has elapsed.
- While the mobile air conditioner is turned on, press the **TIMER** button. The numerical display will start flashing and the timer indicator will be lit.
- Use buttons ▲/▼ to set the time after which the mobile air conditioner should turn off. The time can be set in the range from 1 to 24 hours, in 1 hour increments.
- Wait approximately 5 seconds until the time is saved to memory. Then the automatic countdown of the set time will commence.
- When the set time has elapsed, the mobile air conditioner will turn off and switch to the stand-by mode.
- If you need to cancel the timer, press the **TIMER** button. The remaining countdown time will start flashing. Press the **TIMER** button again and the timer will be cancelled.

2. Sleep function

- The sleep function is used to reduce overnight power consumption, when a constant temperature is not necessary. The function also ensures comfort during sleep since the operation of the air conditioner is quieter and the illumination of the display is dimmed.
- Select a cooling mode and set the default temperature. Then press the **SLEEP** button, to activate the sleep function.
- The fan speed is automatically set to low speed.
- The sleep function cannot be set in the fan and dehumidification modes.

Changing temperature units

- Press the °C/°F button to change the temperature units from °C to °F and vice versa.

C. CONTROL VIA THE SENCOR HOME APPLICATION

- This mobile air conditioner can be controlled via the Sencor HOME application.
- Download the application to your smart phone, register yourself and control the mobile air conditioner via the application.



- If you already have the application installed, add the mobile air conditioner to your devices.

Adding the mobile air conditioner to the list of appliances via Bluetooth

- You can add the mobile air conditioner to the Sencor HOME application by pairing it via Bluetooth.
- Turn on the Bluetooth function on your mobile phone.
 - Turn on the mobile air conditioner.
 - Open the application and on the home screen of the application, click on the icon "+".
 - The appliance will automatically offer the options "Do not add / Go to Add".
 - Click on "Go to Add" and the application will automatically guide you through the addition.



Note:

If the Bluetooth connection fails or is not possible, check that there are no solid obstacles between your phone and the mobile air conditioner and that both devices are close to each other.

Adding the mobile air conditioner to the list of appliances via a QR code

- The mobile air conditioner can also be added to the Sencor HOME application using the QR code provided below. On the home screen of the application, click on the "+" icon and on the Add device screen, click on the [-] icon in the top right hand corner.

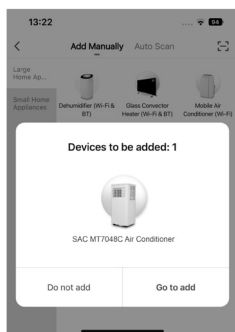

QR code for adding the control panel of the mobile air conditioner to the application Sencor HOME



Manually adding the mobile air conditioner to the device list

- On the main screen, click on "Add device" or on the "+" in the top right hand corner.
- A screen with appliance categories will appear together with a list of appliances.
- Click on "Cooling" and select the mobile air conditioner model from the list of products.
- On the next screen, you will be asked to select a Wi-Fi network. Select a network, enter the password and click on "Next".
- Ensure that the mobile air conditioner is ready for pairing. It is important that the mobile air conditioner is connected to a power source and is in stand-by mode. The Wi-Fi indicator will start to flash quickly on the control panel. If the indicator does not start flashing, hold down the **TIMER** button for 3 seconds until the Wi-Fi indicator starts flashing quickly. In the application, confirm that the Wi-Fi indicator is quickly flashing and click on "Next".
- The mobile air conditioner will automatically be added to the device list. The Wi-Fi indicator will be lit.
- In the device list on the main screen, click on the icon of the mobile air conditioner to enter its control interface.

Wi-Fi reset

- While the mobile air conditioner is in operation, hold down the **TIMER** button for 3 seconds. The Wi-Fi settings will be reset and the Wi-Fi indicator will flash quickly (twice per second).

DRAINING CONDENSATE

- The mobile air conditioner is equipped with two drain outlets, where each one drains condensate from a different part of the air conditioner. When the mobile air conditioner is used frequently, it is necessary to regularly inspect the status of the condensate and to drain it away. If you select the dehumidification operating mode, we recommend draining the condensate using a drain hose that is connected to the top drain outlet.



Note:

In the cooling and fan modes (if the humidity in the room is low), it may not be necessary to drain the condensate. The mobile air conditioner is designed that it increases its efficiency with a small amount of water in the condensate tank.

Condensate drain outlet from the bottom drain outlet

- If the water level inside the water tank reaches a predetermined level, the mobile air conditioner will stop and a beep will be made and the full water tank indicator will be lit. In order to drain the condensate from the air conditioner, proceed as follows:
- Disconnect the power plug from the power socket.
 - Carefully re-locate the mobile air conditioner to a location where the water may be drained.
 - Put a container below the bottom drain outlet, into which the condensate can flow – see figure **G1**. Carefully remove the plug of the drain outlet. If necessary, connect a drain hose and allow the condensate to flow out. You can tilt the mobile air conditioner backwards slightly while emptying out the condensate.
 - Once the water tank is empty (condensate has stopped flowing), disconnect the drain hose, if it was used, and put the plug back into the drain outlet. Prior to turning the mobile air conditioner on again, ensure that the drain outlet plug is correctly inserted and is sealing well. Otherwise condensate could leak out during operation and damage the floor or a carpet.
 - Insert the power plug into a power socket and the mobile air conditioner will automatically resume operation.



Note:

If you turn off the mobile air conditioner using the **POWER** button, the operation will not resume automatically and it will be necessary to set it up again.



Note:

If the mobile air conditioner is added to the device list in the Sencor HOME application, the full water tank warning will appear also directly in the application in the same way as other warning messages.

Condensate drain outlet from the top drain outlet

- The top drain outlet serves for the continuous draining of condensate.
- Disconnect the power plug from the power socket.
 - Remove the plug of the drain outlet. Connect the drain hose – see figure **G2**. If the length of the drain hose is insufficient, then it is necessary to purchase a longer hose of the same type. Never extend the length of the drain hose using extensions.
 - Connect the end of the drain hose to the waste water drain.
 - Insert the power plug into a power socket and turn on the mobile air conditioner.



Note:

The drain hose should be installed at the same height or lower than the top drain outlet. Otherwise, the condensate will not be properly drained from the water tank.

SAFETY PROTECTIVE ELEMENTS

Acoustic notification and shut off when the water tank is full.

- If the water level inside the water tank reaches a predetermined level, the mobile air conditioner will stop and a beep will be made and the full water tank indicator will be lit.
- It is necessary to empty out the condensate tank. Proceed according to the instruction in section **"DRAINING CONDENSATE"**.

Protection of the compressor

- The compressor is equipped with timed protection against damage caused by repeat turning off and on with a duration of 3 minutes. In the event that the mobile air conditioner is turned on shortly after being turned off, the compressor will start only after 3 minutes.

Room temperature sensor and coil malfunction

1. Detects the malfunction of the sensor when the unit is turned on or when in operation.
2. If the malfunction is detected when the mobile air conditioner is turned on, then it is immediately set into the error state. If it returns to the normal state within this period, the mobile air conditioner will switch to the stand-by mode.

TIPS FOR CORRECT OPERATION

- To ensure the correct operation of the mobile air conditioner, we recommend adhering to the following:
 - Close all windows and doors of the room in which the mobile air conditioner is used. If the mobile air conditioner is installed in a room temporarily then you can leave the door slightly ajar (approx 1 cm) to ensure proper ventilation.
 - Prevent direct sunlight from coming into the room. Cover the window/s using drapes or roller shutters to ensure economical operation of the air conditioner.
 - Do not block the air inlets and outlets.
 - Make sure that there is no heat source located in the room.
 - Never use the mobile air conditioner in excessively humid environments, for example in laundries.
 - Never use the mobile air conditioner outdoors.
 - Ensure that the mobile air conditioner is located on a level surface. If necessary, install special brakes on to the travel wheels.

MAINTENANCE AND CLEANING

- Before cleaning the mobile air conditioner, turn it off and wait a few minutes, and then pull the power cord out of the power socket.

Cleaning the protective grilles and air filters

- If the mobile air conditioner is used regularly, clean the protective grilles and air filters at least once every two weeks to avoid the fan from becoming clogged with dust.
- Carefully remove the protective grilles and remove the filters – see figure **H**. Use a vacuum cleaner to remove dust from the grilles and filters.
- In the event of greater soiling, wash the filters by hand in a solution of lukewarm water (max. 40 °C) and neutral detergent. Then thoroughly rinse under running water and allow to dry naturally. Do not dry it in a clothes dryer or in direct sunlight. Once the filters are dry, you can install them back in their place.
- In the event of greater soiling, you can wipe the protective grilles using a lightly dampened cloth and then wipe dry using a clean wiping cloth.



Note:

Do not use the mobile air conditioner without the air filters and protective grilles properly installed. Never install wet or damp air filters and protective grilles into the mobile air conditioner.

Cleaning the outer case

- To clean the outer case, use a soft wiping cloth dipped in a solution of lukewarm water and neutral detergent. Then wipe the surface dry.

- When cleaning it, do not spray the mobile air conditioner with water or any other liquid, do not pour water on it or submerge it in water or in any other liquid.
- Do not use abrasive cleaning products, solvents, petrol, etc. for cleaning.

Storing the mobile air conditioner

- In order to dry it and to prevent the formation of moulds, leave the mobile air conditioner running in a warm room in the fan mode for approximately 12 hours.
- Disconnect the flexible hose and store it in a safe place out of the reach of children.
- Drain all the condensate from the water tank – see chapter **"DRAINING CONDENSATE"**.
- Clean the air filters and reinstall them. Wipe the outer case of the mobile air conditioner. Remove the batteries from the remote control.
- Store the air conditioner in a cool, dry and dark location.

Putting into operation again

- Check that the power cord and plug are not damaged and that the air filters are clean. Insert a new set of batteries into the remote control. Proceed according to the instructions in section **"Inserting and replacing batteries"**. Install the mobile air conditioner according to the instructions contained in the preceding part of this user's manual **"Installation"**.

TROUBLESHOOTING

- Before contacting an authorised service centre, please check the appliance according to the following instructions:

Problem	Possible cause	Remedy
The mobile air conditioner did not turn on.	The power cord is not plugged into the power socket, or the power socket has no voltage.	Insert the power plug properly into the power socket, or check that the socket has voltage.
	The condensate tank is full.	Empty out the tank according to the instruction in section "DRAINING CONDENSATE" .
	The ambient temperature is too low or too high.	It is recommended to use the mobile air conditioner at temperatures from 5 °C to 35 °C.
The mobile air conditioner does not cool sufficiently.	The temperature in the room is lower than the set temperature (cooling mode).	Adjust the set temperature.
	The mobile air conditioner is exposed to direct sunlight.	Move the mobile air conditioner to another location or shade it.
	The windows and doors of the room are open and warm air is flowing through them into the room, or there are heat sources turned on in the room.	Make sure that all doors and windows are closed and/or that heat sources are turned off.
	The air filter is dirty.	Turn off the air conditioner and clean out the air filters according to the instructions in section "Cleaning the air filter" .
	Air inlet or outlet vents are blocked.	Elimination the cause of the blockage.

The mobile air conditioner is too loud.	The air conditioner is located on an uneven surface.	Turn off the air conditioner, disconnect the power plug from the power socket and move it to an even and level location.
The compressor is not working.	Overheating protection was activated.	Wait 3 minutes until the temperature falls. Operation will then resume automatically.
The remote control doesn't work.	The distance between the remote control and the mobile air conditioner is too great.	Move closer to the mobile air conditioner and ensure that there are no obstacles between the mobile air conditioner and the remote control.
	The remote control is not pointing at the signal sensor.	
	The batteries are flat.	Replace the batteries.

Recommended room size (Central Europe)*	54–67 m ³
Maximum room dimension	26 m ² / 67 m ³ (ceiling height 2.6 m)

* applies for the calculated climatic conditions value typical for Central Europe. For standard rooms with ceilings at standardised heights. The provided values may differ when the appliance is used in sectioned areas, in areas with multiple heat sources, heavily glazed or/and poorly insulated areas. If you know that you are purchasing the air conditioner for an area with the above-described characteristics, select a model with a higher power output for the given area.

The declared noise emission level of the appliance is 64/61 dB(A), which represents a level A of acoustic pressure with respect to a reference acoustic power of 1 pW.



Note:

The efficiency of the mobile air conditioner may be reduced in the event that it is used outside the above described operating temperature range.

Error messages

Shown on the display	Meaning	Solution
E1	Room temperature sensor malfunction	Contact an authorised service centre.
E2	Heat pipe sensor malfunction	Contact an authorised service centre.
Full tank indicator is lit.	The condensate tank is full.	Empty out the tank according to the instruction in section "DRAINING CONDENSATE" .



Note:

In the event that one of the aforementioned faults occurs, turn off the mobile air conditioner and check for the cause of the fault. Turn it on again, and if the fault reoccurs, turn it off, disconnect the power cord from the power socket and contact the manufacturer, an authorised service centre or a person with relevant qualifications and have the unit repaired.

We reserve the right to change text and technical specifications.

DISPOSAL OF USED BATTERIES



Batteries contain environmentally damaging compounds and, therefore, do not belong in standard communal waste. Hand over used batteries for proper disposal at locations intended for their collection.

SENCOR hereby declares that the radio devices SAC MT7048C and SAC MT7049C are in compliance with directive 2014/53/EU. The full wording of the declaration of conformity can be found at the website www.sencor.cz.

INSTRUCTIONS AND INFORMATION REGARDING THE DISPOSAL OF USED PACKAGING MATERIALS

Dispose of used packaging material at a site designated for waste in your municipality.

TECHNICAL SPECIFICATIONS

Power supply	220-240 V ~ / 50 Hz
Cooling power output	7 000 BTU/hour
Cooling power input	760 W
Current consumption	3.4 A
EER cooling factor	2.63
Dehumidification capacity	20 l/day
Capacity of the built-in condensate tank	0.7 l
Refrigerant type and weight	R290 / 125 g
Air flow volume	300 / 220 m ³ /hour (high/low)
Acoustic pressure value	62 / 61 dB (A) (high/low)
Acoustic power value	53 / 50 dB (A) (high/low)
Maximum permitted operating pressure value (low/high):	2 / 2.6 MPa
Dimensions of the mobile air conditioner (w x d x h)	340 x 300 x 694 mm
Weight	18.7 kg
Operating temperature (cooling)	17 to 30 °C
Recommended room area (Central Europe)*	21–26 m ²

DISPOSAL OF USED ELECTRICAL AND ELECTRONIC EQUIPMENT



This symbol on products or original documents means that used electric or electronic products must not be added to ordinary municipal waste. For proper disposal, renewal and recycling, hand these appliances over to determined collection points. Alternatively, in some European Union states or other European countries you may return your appliances to the local retailer when buying an equivalent new appliance. Correct disposal of this product helps save valuable natural resources and prevents potential negative effects on the environment and human health, which could result from improper waste disposal. Ask your local authorities or collection facility for more details. In accordance with national regulations penalties may be imposed for the incorrect disposal of this type of waste.

For business entities in European Union states

If you want to dispose of electrical or electronic equipment, ask your retailer or supplier for the necessary information.

Disposal in other countries outside the European Union.

This symbol is valid in the European Union. If you wish to dispose of this product, request the necessary information about the correct disposal method from the local council or from your retailer.



This product meets all the basic requirements of EU directives related to it.

