

RANGE HOOD

USER'S MANUAL

PHILCO



Famous for Quality the World Over

PEW 612

PEW 912

Dear customer,

Thank you for buying a PHILCO brand product. So that your appliance serves you well, please read all the instructions in this user's manual.

CONTENTS

PART 1: IMPORTANT SAFETY INSTRUCTIONS.....	2
PART 2: DESCRIPTION OF THE APPLIANCE	4
PART 3: INSTALLATION	5
Unpacking.....	5
Dimensions of the appliance	5
Placement	6
Installation	7
Carbon filter.....	11
Ventilation.....	12
PART 4: OPERATION	13
Operating tips.....	13
PART 5: MAINTENANCE AND CLEANING.....	14
Changing a light bulb.....	14
Cleaning.....	15
PART 6: BEFORE YOU CALL THE SERVICE CENTRE	16
PART 7: TECHNICAL SPECIFICATIONS.....	17

PART 1: IMPORTANT SAFETY INSTRUCTIONS

Recommendation:

Carefully read these instructions before installing and operating this range hood.

Write down the serial number found on the rating label of the range hood in the space below. It is essential that you store this user's manual in a safe place so that you can use it in the future. If you intend to sell the appliance, give it to another owner, or if you move, always make sure that the user's manual is attached to the appliance, so that the new owner can also learn about the operation of the appliance and the relevant warnings.

SERIAL NUMBER:

Important safety instructions

- This appliance is designed for household use only.
- Before connecting the power cord plug, make sure the voltage stated on the rating label of the appliance corresponds to the voltage in your wall socket. Connect the power cord plug to a power socket with a voltage of 220 – 240 V ~ 50 Hz.
- Only use a properly grounded power socket. The appliance may only be connected to a properly grounded power socket.
- All electrical connections must be performed by a qualified electrician.
- Installation performed by an unqualified person may cause incorrect operation, damage to the appliance, create a fire hazard or cause injury to persons.
- Neither the manufacturer nor the vendor take responsibility for damages cause by incorrect or unprofessional installation, connection or operation. Tampering with the appliance by an unqualified person will void the customer's right to a warranty repair.
- Do not expose the power cord to excessive pressure or loads, do not place heavy objects on it, it must not be tangled and it must not be stepped on. Do not locate the power cord in or on heat sources such as stoves, heating or other generators of heat. Otherwise this may damage the power cord or create a fire hazard.
- Only connect the power cord plug to a power socket after the entire installation is completed.
- The power plug serves as a disconnection device and for this reason the power socket must remain easily accessible for the event of a dangerous situation, unless it is connected into a terminal box.
- Do not touch the lights if the appliance has been running for some time. Lights heat up during operation and may cause burns.
- This appliance is designed for fume extraction during standard domestic use. Do not use the appliance for purposes other than those for which it was designed. Otherwise you expose yourself to the risk of a dangerous situation and voiding the warranty.
- Follow the instructions for installation and ventilation (with the exception of when a fire stove is used).
- Do not use the flambé cooking method under the range hood.
- Regularly replace the filters in the range hood. Otherwise this presents a fire hazard.
- Only use filters suitable for use with the range hood. The manufacturer or distributor will recommend the suitable filter type.
- Do not use the appliance without the aluminium filter inserted. Do not take out the filters while the appliance is on.
- Regularly clean the appliance to prevent a dangerous situation from occurring.
- Before cleaning, replacing filters, moving or any other maintenance, turn off the appliance and pull out the power plug from the power socket, or turn off the respective circuit breaker.
- If you are using another gas or natural gas appliance in the room at the same time, the fumes from this appliance must be spatially isolated.

- If a chimney is connected to the exhaust of the range hood, use pipes with a diameter of 150 or 120 mm. The pipe connection should be as short as possible.
- Keep packaging materials out of children's reach. They could suffer injury or suffocation.
- Children must be supervised to ensure that they do not play with the appliance. If the power cord is damaged stop using the appliance. Have the power cord replaced at an authorised service centre or by another qualified person. Under no circumstances should you replace the power cord yourself.

To ensure safety, use a fuse with a maximum rating of 6 A.



WARNING!

This appliance must not be used by persons (including children) with physical or mental impairments or by inexperienced persons, unless properly trained or schooled in the safe use of the appliance, or unless they have been properly supervised by a qualified person who will be responsible for their safety.

Attention when transporting or carrying

The packaging materials are from recyclable materials, so dispose of them in an environmentally conscientious manner according to regulations in force.

During transport adhere to the symbols of the cardboard box.

When carrying the appliance, hold it by the respective handles.

NOTE:

We recommend that you keep the original packaging at least for the duration of the warranty period for the event of repair or refund and transport to the authorised service centre. Adhere to the symbols on the cardboard box.

If you do not have the original cardboard box, adhere to the following instructions:

- Do not place any items on the appliance that could damage the appliance during transport.***
- Protect the appliance against impacts, falls, etc.***
- Wrap the appliance, e.g. in bubble wrap which will protect the appliance from damage.***

NOTE:

The carbon filter is not included.

NOTE:

If the building is equipped with a heat recovery system system, it is necessary to setup the appliance for internal air circulation (without an exhaust). In that case, it is necessary to purchase the carbon filter.

PART 2: DESCRIPTION OF THE APPLIANCE

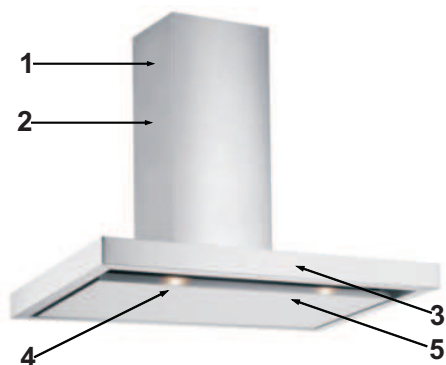

1. Inner chimney
2. Outer chimney
3. Control panel
4. Lighting
5. Separating plate

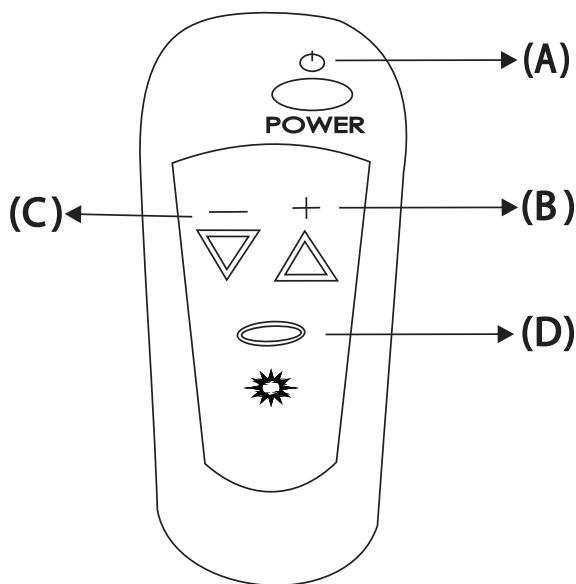

- A. Turn the appliance on / off
- B. Increase the exhaust power
- C. Decrease the exhaust power
- D. Turn the lights on / off

PART 3: INSTALLATION

Unpacking

- After unpacking remove all packaging and advertising labels from the appliance.
- Check that the appliance has not been damaged and that the package includes all the items described in this user's manual.
- If the appliance was damaged during transport, contact authorised service centre.
- Do not use a damaged appliance under any circumstances.

IMPORTANT:

Ensure that children do not play with the packaging material.

Dimensions of the appliance

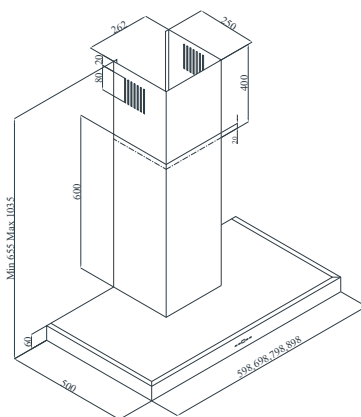

IMPORTANT:

Before installing or using the appliance, please first read all instructions and check that the voltage and frequency values on the rating label correspond to the voltage and frequency in your electricity grid.

We recommend that the appliance be connected by a service technician or another qualified person in compliance with local codes and regulations.

Before starting the installation

- Check that the purchased appliance has the correct dimensions corresponding to the chosen installation location. Furthermore ensure that there is an electrical power socket available that will remain accessible even after the range hood is installed.
- Before installing the range hood, check that all necessary masonry work is complete.
- Have all electrical connections performed by a qualified person.
- We recommend that you remove the aluminium filters before installing the range hood.
- Check that there are no packaging materials or other materials, e.g. user's manual, warranty card or bags with screws, inside the appliance. These need to be taken out and kept for possible use in the future.
- We recommend that you disconnect and move to the side freely standing or built in stoves so that you have easier access to the rear wall or ceiling. If this is not possible place protective material on to the work area, cooktop or stove. This will prevent damaging these surfaces.

- Select an even surface for the necessary assembly of the range hood. Cover the surface with a protective material and place all parts of the range hood and fastening elements on to it.
- It is necessary that a qualified technician inspects the suitability of the supplied fastening material and other components for the specific wall / ceiling type. The wall / ceiling must be sufficiently strong to hold the weight of the range hood.
- Do not attach this range hood to a wall or cabinet furniture by tiling, plastering and do not glue it on using silicone glue. The appliance is designed to only be installed on a wall / ceiling.
- We recommend that always two people perform the installation of the appliance.

If your range hood is designed to be mounted to the ceiling, adhere to the following instructions.

- 1) The range hood must only be suspended on ceiling beams or on load bearing ceiling beam connections.
- 2) **Do not suspend** the range hood on false ceilings.
- 3) The ceiling **must** have a load bearing capacity of at least 40 kg.
- 4) The ceiling thickness **must** be at least 30 mm.

IMPORTANT:
THE RANGE HOOD MAY ONLY BE CONNECTED TO THE ELECTRICAL GRID AFTER THE ENTIRE INSTALLATION IS COMPLETE.

Placement

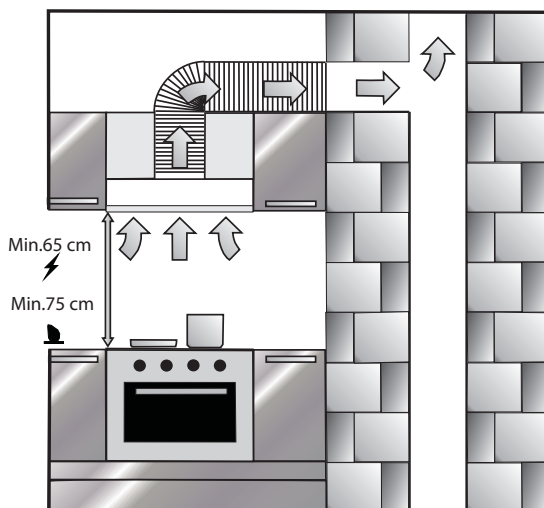

Install the range hood at a height of at least 65 cm above an electric cooktop or at a height of 75 cm above a gas cooktop.

Installation

1) Installation of hanging brackets

To hang the range hood it is necessary to first install 2 L-shaped hanging brackets, which are supplied together with the screws, on to the range hood according to the illustration below. Then secure the brackets using appropriate M5 x 40 screws into an M5 thread.

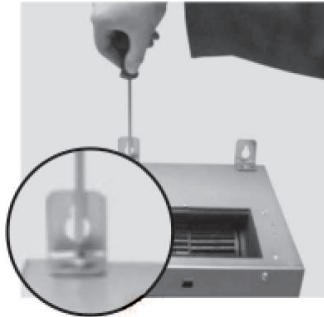

2) Installation of the non-return exhaust flap

Install the non-return exhaust flap on to the top part of the range hood using 3.5 x 9.5 screws according to the illustration below.



3) Drilling mounting holes

Place the installation template against the wall and drill holes in points A, B, and C using a drill bit with a diameter of 8 mm. To install the chimney, drill holes using a drill bit with a diameter of 6 mm adhering to the dimensions for the minimum and maximum height.

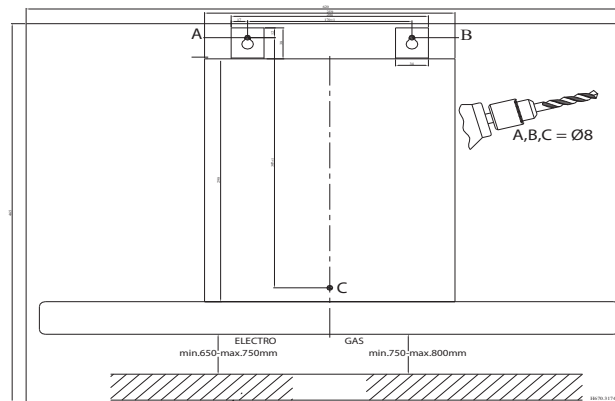



WARNING!

When drilling the mounting holes used for hanging the range hood, ensure the holes have the correct diameter. If the holes are drilled incorrectly, then the correct assembly of the range hood will not be possible.

4) Inserting dowels

Into the drilled holes A, B and C with a diameter of 8 mm, insert dowels with a diameter of 8 mm. Into the two holes with a diameter of 6 mm, insert dowels with a diameter of 6 mm – see illustration below.



5) Attaching the chimney plate

Drill holes into the wall using a drill bit with a diameter of 6 mm. Attach the chimney plate by screwing 3.9 x 22 screws into the plastic dowels with a diameter of 6 mm.

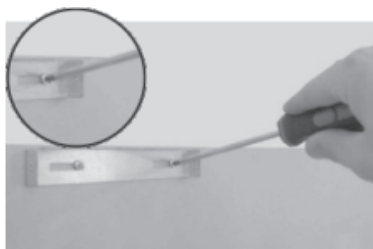

Into the drilled holes A, B with a diameter of 8 mm, with the dowels inserted, screw in two 5.5 x 45 screws. The distance between the wall and the head of the screw must be 5 mm.

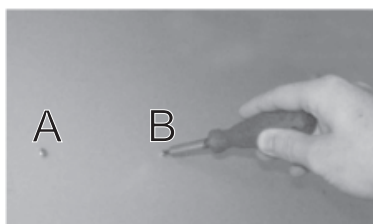

6) Hanging the range hood

Hang the range hood using the hanging brackets on to the screws in holes A and B – see illustration below.

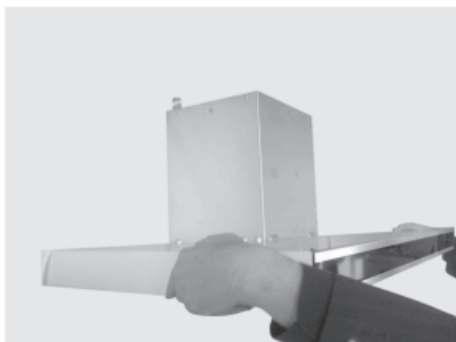

7) Tightening screws

After hanging the range hood, tighten the screws to secure the range hood in place.



8) Tightening the hanging screws

In point C (see illustration below) tighten the hanging screws to ensure that it is hung safely.

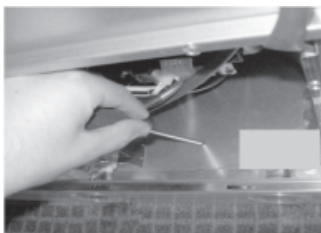

NOTE:

In the event that the range hood deviates, use M5 screws on the top side of the range hood to provide additional support.

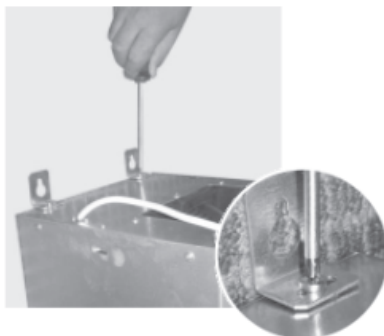

9) Installation of the aluminium duct tube

Attach the flexible aluminium duct tube on to the air exhaust in the top part of the range hood and insert the other end into the exhaust opening in the wall. Check that the connection is secure even at full power.



Bends and deviations in the aluminium flue pipe reduce the exhaust performance, so it is essential that the pipe is bent as little as possible.



Right



Wrong

10) Installation of the chimney

Install the chimneys around the base.



Attach the inside part of the range hood to the chimney, which is attached to the wall. Pull the inner chimney out of the outer chimney and attach to the plate using screws.



11) Removing the separation plate

Hold the plate in the top right and top left corners and pull out the plate.



After completing the installation check that the range hood is correctly installed and works properly.

Carbon filter

If you are using the range hood without an air exhaust, it is necessary to use a carbon filter. The carbon filter is not included. Contact your vendor or an authorised service centre to purchase this filter.

- Before installing or replacing the carbon filter, check that the appliance is turned off and disconnected from the power socket or that the respective circuit breaker is turned off.
- It is necessary to replace the carbon filter regularly every 3 – 5 months depending on how much the appliance is used.
- Never wash the carbon filter in water unless the manufacturer states otherwise.
- Aluminium filters must always be installed even when the carbon filter is not installed. Do not use the appliance without the aluminium filter installed.



Replacing the carbon filter

1. For the correct operation of the appliance it is necessary to install a carbon filter. The number and type depends on the model.
2. Place the carbon filter on the motor outlets and turn it in the clockwise direction.
3. To remove the carbon filter turn it in the anticlockwise direction.

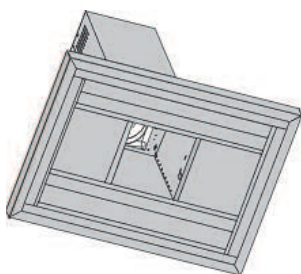

or

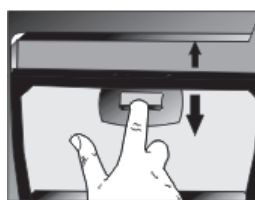

Ventilation

To ensure proper ventilation, leave windows closed while the appliance is turned on.



WARNING!

Pay increased attention if you are using the appliance together with another appliance that uses air or fuel for its operation (e.g. heating fan, fan, etc.) or that uses gas, coal or wood, as its operation may negatively affect the performance of the range hood because it expels air out of the room. This warning does not apply if you installed the appliance without an exhaust out of the room.

PART 4: OPERATION

Remove the protective foil from the control panel.

Exhaust power selection

This range hood is equipped with 5 levels of exhaust power. Select the power level based on the use of the stove and the amount steam that the pots emit.

To turn on the motor press the  button and to set the exhaust power level press the + or – button. Press the + button to increase the exhaust power and the – button to reduce the exhaust power.



Automatic timer (TIMER)

Press and hold the  button at the set exhaust power level for at least 2 seconds and the automatic timer function will be turned on for a period of 15 minutes. When the function is turned on, the respective symbol will appear on the display and the motor will turn off automatically after 15 minutes.

NOTE:

Use the range hood together with the stove. This will ensure the correct air exhaust. We recommend to leave the range hood running a few minutes longer than the stove to ensure that all odours are extracted.

Lighting

The range hood is equipped with lighting. Press the button with the light symbol to turn on the lights. Press the button again to turn the lights off.

Operating tips

1. Regularly clean the aluminium filters and regularly replace the carbon filters.
2. Use the medium exhaust power level. Only use the highest power level when necessary.
3. To ensure proper ventilation, leave windows closed while the appliance is turned on.

BOOST INTENSIVE VENTILATION MODE

The model have been purchased has intensive ventilation mode with the intent of energy efficiency.

Boost Mode: Product symbol (b) will be appearing on the screen when the latest speed is in use .

The symbol b signifies boost mode (intensive ventilation) is active.

Product will be working along 6 minutes with this mode and the symbol b will blink during this time.

At the end of 6 minutes product will be passing to lower speed level automatically and will proceed working in this speed level.

NOTE:

Timer feature is not used in boost mode.

PART 5: MAINTENANCE AND CLEANING



WARNING!

Before cleaning, regular or other maintenance, installation or removal, check that the appliance is turned off and disconnected from the power socket or that the respective circuit breaker is turned off.

Changing a light bulb

- Turn off the appliance.
- Take out the aluminium filter.
- If the light bulb broke during operation wait until it cools down.

Models with a 3W halogen light bulb

- To remove the halogen light bulb (3 W), press the light bulb holder downwards and gently turn it anticlockwise. Remove the light bulb.
- Install a light bulb with the same parameters in reverse sequence.

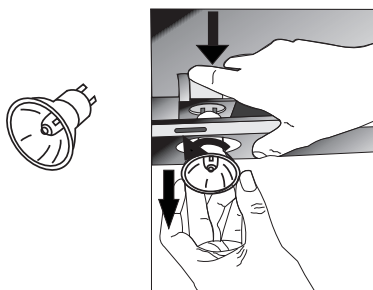

Models with a 1,5W light bulb

- To remove the halogen light bulb (1,5 W), first remove the glass cover using a thin screwdriver. Be careful not to scratch the appliance. Remove a faulty light bulb by pulling downwards and insert a new working light bulb.
- Use a light bulb with the same parameters.

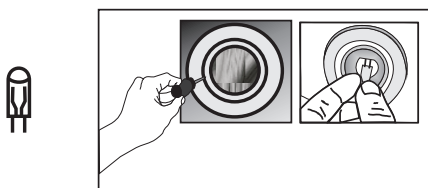

NOTE:

Do not hold the light bulb with your bare hands. Dirt or sweat from the hand may shorten their lifetime.

Cleaning

- Aluminium filters capture dust and fat from the extracted air.
- It is necessary to regularly wash these filters, ideally once a month, depending on the level of use. Wash the filters in water with dishwashing detergent, or you may place the filters in a dishwasher and wash them using a gentle program (max. 60 °C).
- Take out the aluminium filters by pressing the clip.
- After cleaning allow the aluminium filters to dry thoroughly before reinstalling them.
- Wipe the outer surface of the range hood with a clean damp wiping cloth lightly dipped in water with a small amount of dishwashing detergent. Then wipe dry.
- Avoid electrical parts coming into contact with water or another liquid.
- For cleaning you can also use special agents for the maintenance and cleaning of INOX surfaces (applies only to surfaces with an INOX surface treatment).

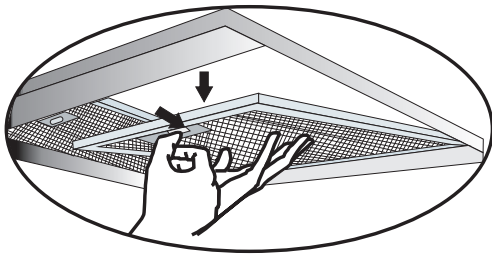

Cleaning the aluminium filters

The aluminium filters need to be cleaned when "C" appears on the display (depending on the model). Clean the filters according to the above mentioned instructions and after reinstalling them press and hold down the fan button for 3 seconds until the "C" symbol (depending on the model) disappears from the display. The symbol "E" (depending on the model) will appear on the display, which means that the appliance is ready for operation.

If you wish to use the appliance without clearing the "C" symbol (depending on the model), press the fan button to start extraction for 1 second, then the "C" symbol (depending on the model) will appear again and the motor will continue running.

NOTE:

The "C" symbol (depending on the model) appears on the display after approximately 60 hours of operation.



WARNING!

For cleaning do not use petrol, benzene, thinners or any other solvents, coarse cleaning agents, steel wool or any sponges with steel wool.



WARNING!

You may put the aluminium filters in a dishwasher. The colour of the aluminium filters may change after several washes. This is normal.

PART 6: BEFORE YOU CALL THE SERVICE CENTRE

If the appliance is not working as it should check the following recommendations for resolving the most common problems.

If the problem persists or it is not included in the table below, turn off the appliance and disconnect it from the power socket and contact an authorised service centre.

Problem	Solution
The range hood is not working.	Check that the power plug is properly inserted in a properly grounded power socket with the parameters 220 – 240 V ~ 50 Hz.
	Check that the motor power switch is in the "On" position.
The lights are not working.	Check that the power plug is properly inserted in a properly grounded power socket with the parameters 220 – 240 V ~ 50 Hz.
	Check that the motor power switch is in the "On" position.
	Check whether the light bulb or fluorescent tube is broken.
Exhaust power is weak.	Check whether the aluminium filters are dirty.
	Check the air outlet, it should be open.
	Check whether the carbon filter is not too dirty.
The range hood does not extract the air directly out (for models without an exhaust).	Check whether the aluminium filters are dirty.
	Check whether the carbon filter is not too dirty.

ATTENTION:

Use the range hood together with the stove. This will ensure the correct air exhaust. We recommend to leave the range hood running a few minutes longer than the stove to ensure that all odours are extracted.

PART 7: TECHNICAL SPECIFICATIONS

		PEW	
SPEED 1	Voltage (A)	0,5	0,6
	Power (W)	105	90
	Air flow (m ³ /h)	180	230
	Pressure (mmH2O)	130	155
	Noise level (dB)	36	35
SPEED 2	Voltage (A)	0,6	0,9
	Power (W)	125	120
	Air flow (m ³ /h)	260	310
	Pressure (mmH2O)	200	205
	Noise level (dB)	43	42
SPEED 3	Voltage (A)	0,7	1,5
	Power (W)	145	185
	Air flow (m ³ /h)	335	500
	Pressure (mmH2O)	265	245
	Noise level (dB)	48	52
SPEED 4	Voltage (A)	0,8	
	Power (W)	170	
	Air flow (m ³ /h)	450	
	Pressure (mmH2O)	310	
	Noise level (dB)	53	
SPEED 5	Voltage (A)	1	
	Power (W)	210	
	Air flow (m ³ /h)	750	
	Pressure (mmH2O)	350	
	Noise level (dB)	61	
Input voltage		220 - 240 V ~ 50 Hz	220 - 240 V ~ 50 Hz
Air outlet diameter		150 mm	150 mm

NOTE: All the here mentioned data is subject to change.

INSTRUCTIONS AND INFORMATION REGARDING THE DISPOSAL OF USED PACKAGING MATERIALS

Dispose of packaging material at a public waste disposal site.

DISPOSAL OF USED ELECTRICAL AND ELECTRONIC APPLIANCES



The meaning of the symbol on the product, its accessory or packaging indicates that this product shall not be treated as household waste. Please, dispose of this product at your applicable collection point for the recycling of electrical & electronic equipment waste. Alternatively in some states of the European Union or other European states you may return your products to your local retailer when buying an equivalent new product. The correct disposal of this product will help save valuable natural resources and help in preventing the potential negative impact on the environment and human health, which could be caused as a result of improper liquidation of waste. Please ask your local authorities or the nearest waste collection centre for further details. The improper disposal of this type of waste may fall subject to national regulations for fines.

For business entities in the European Union

If you wish to dispose of an electrical or electronic device, request the necessary information from your seller or supplier.

Disposal in other countries outside the European Union

If you wish to dispose of this product, request the necessary information about the correct disposal method from local government departments or from your seller.



This product meets all the basic EU regulation requirements that relate to it.

Changes to the text, design and technical specifications may occur without prior notice and we reserve the right to make these changes.