



FZR 2048 E

---

English .....3 - 16  
Čeština..... 17 - 30  
Slovenščina..... 31 - 44  
Magyarul.....45 - 58  
Polski .....59 - 78

# Electric Lawn mower

## USER MANUAL

**Thank you for purchasing this rotary electric lawn mower.**

**Before you start using it, please read this user manual carefully and save it for future use.**

## TABLE OF CONTENTS

1. GENERAL SAFETY REGULATIONS.....	4
Important safety notice .....	4
Packaging .....	4
User manual.....	4
2. SYMBOLS .....	5
3. DESCRIPTION (FIG. 1.).....	6
4. BASIC WORK SAFETY .....	7
Other risks .....	7
Before you start using the lawn mower .....	8
Preparing for operation .....	8
Operation .....	8
Maintenance and storage .....	9
5. ASSEMBLY .....	10
5.1 Handle .....	10
5.2 Assembling and mounting the grass catcher .....	11
5.3 Extension cable / securing the power cable.....	11
6. OPERATION .....	12
6.1 Setting the mowing height.....	12
6.2 Setting the handle HEIGHT .....	12
6.3 Connecting to the electricity.....	12
6.4 Turning the lawn mower on/off .....	12
7. TECHNICAL SPECIFICATIONS.....	13
8. Troubleshooting.....	14
9. MAINTENANCE.....	15
9.1 Blade replacement.....	15
10. DISPOSAL .....	16

# 1. GENERAL SAFETY REGULATIONS

## IMPORTANT SAFETY NOTICE

- ✿ Unpack the product carefully and do not throw away any of the packaging until you have found all the parts of the product.
- ✿ Store the product in a dry place out of reach of children.
- ✿ Read all the warnings and instructions. Not following warnings or instructions may lead to electrical shocks, fire and/or serious injuries.

## PACKAGING

The product's packaging prevents damage during transport. This packaging is a resource and can be recycled.

## USER MANUAL

Before you start working with the power tool, read the following safety and use instructions. Make sure you know the operating elements and the correct use of the power tool. Keep the User manual in a safe place where it can be easily found for future use. Save the original packaging, including the internal packing material, guarantee card and proof of purchase receipt for at least the time of the guarantee. If you need to transport this power tool, pack it in the original cardboard box for maximum protection during shipping or transport (e.g. when moving or when you need to send this power tool to a service centre for repair).

 **Note:** If you hand over this appliance to somebody else make sure you include this user manual. Make sure you use the appliance properly by following the instructions in the included User manual. The User manual also contains operating, maintenance, and repair instructions.

**The manufacturer takes no responsibility for accidents or damages from not following the instructions in this manual.**

## 2. SYMBOLS



Read the manual with the instructions before using this machine.



Bystanders must be at a safe distance.



Be careful of the sharp blade edges. The blades continue to rotate even after the motor is turned off. Before carrying out maintenance or if the power cable is damaged, disconnect the plug from the mains.



Keep the flexible power cable at a safe distance from the blade.



The blades will continue rotating even after the machine is turned off. Before touching any of the machine's components, wait until they completely stop.



Do not mow grass in the rain and do not leave the lawn mower uncovered in the rain.



Use ear protection.  
Use eye protection.  
Use breathing protection.

### 3. DESCRIPTION (FIG. 1.)

1. Start/stop trigger
2. Start/stop trigger safety lock
3. Top part of the handle
4. Handle fast clamp
5. Bottom part of the handle
6. Transport handle
7. Mowing height adjustment lever
8. Bottom handle quick couplers - handle height adjustment
9. Power cord plug



FIG. 1

## 4. BASIC WORK SAFETY

- ✿ Never use the machine if the power cable is damaged or visibly worn.
- ✿ If the lawnmower is connected to a power source using a damaged power cable and the place that is not insulated is touched before the lawnmower is disconnected from the power source, you risk being electrocuted.
- ✿ Also, never touch the blades until the machine is disconnected from the power source and until the blades completely stop.
- ✿ Make sure that the extension cable never comes into contact with the blades. The blades could damage the power cable insulation and create a risk of an electric shock when a part of the body touches the exposed wire when it is live.
- ✿ Disconnect the machine from the voltage source (i.e. pull the power cable plug out of the mains power socket):
  - If you need to leave the machine without supervision
  - If you have to leave the machine unsupervised
  - Before every inspection, every cleaning or repairs
  - If you hit a foreign body when working with it
  - If the machine vibrates excessively.
- ✿ Read carefully the basics of working safely with the machine and the user's manual.
- ✿ Recommendation: Only connect the machine to a power source that has a residual current device (RCD) with a maximum leakage current of 30mA.
- ✿ If the power cable is damaged, it must be replaced by the manufacturer or by a customer service centre.
- ✿ This machine must not be operated by anyone with limited physical, sensory or mental abilities (including children). Furthermore, it must not be used by inexperienced people who do not have the technical knowledge to operate it. These people must be supervised by a competent person or instructed about the basics of work safety.
- ✿ If children are near the machine, make sure they do not play with it.
- ✿ Tingling or numb hands are indications of excessive vibrations.  
If this happens, shorten the work cycle, take sufficiently long breaks, share the work among several people or if the lawnmower is used for long periods wear special anti-vibration gloves.
- ✿ An unavoidable consequence of using the lawnmower is the noise when it is running. Therefore, only do noisy work during dedicated hours, or when this type of activity is normal. Respect quiet times and try to limit the work to the shortest possible time.  
We also recommend that you and persons near the lawnmower wear ear protectors.

### OTHER RISKS

- ✿ Despite our products being designed to meet the valid technical standards and safety directives, there are still some risks to the user from using the machine:
  - Stones and other fragments may fly out of the mowing deck.
  - If the machine operator does not use ear protectors, then they risk subsequent deafness.
  - Injured fingers during blade maintenance
  - Inhaling grass clipping particles
  - Electric shock from un-insulated parts.

- ✿ This machine must not be operated by those with limited physical, sensory or mental abilities (including children) or inexperienced persons or persons whose technical knowledge is evidently insufficient for the given task; and these people should only operate the device under the supervision of a person that is competent for this task or where the person is thoroughly instructed in working safely with the machine.
- ✿ If children are near the machine, make sure they do not play with it.

**⚠ ATTENTION!** Carefully read the user manual before using this lawn mower. Make sure that you thoroughly know all the control elements. Following the work safety rules for the machine minimises the risk of fire, electric shock or other injuries.

- ✿ Keep the user manual carefully in case it is needed.
  - ✿ If the machine is incorrectly operated it could cause an injury. The lawnmower could cause serious injury to the user and those nearby and therefore these work safety rules should always be followed to eliminate this risk if possible.
- The user is responsible for safety when working with the machine. Never use the machine if any of its safety items are missing or not in full working order.

## BEFORE YOU START USING THE LAWN MOWER

- ✿ Carefully read all the instructions provided in this user manual. Thoroughly get to know the machine's control elements and the basics for correct use.
- ✿ Never let children or anyone who you are not certain know the controls and the work safety rules for this machine operate it on their own. The national legislation may also stipulate a minimum age limit for operating this type of machine. Please read the laws governing this area in your country.
- ✿ Never use the lawnmower if people, particularly children or household pets, are moving nearby.
- ✿ Always remember that the user is fully responsible for injuries or damage to property caused by operating this machine.

## PREPARING FOR OPERATION

- ✿ When working with the machine wear suitable footwear and long trousers. Never operate the lawnmower barefooted or in sandals.
- ✿ Before starting work, inspect the ground and remove any items that could be deflected by the machine.

**⚠ ATTENTION!** Before every use of the machine, make sure that the blade, its mounting pin and the lawn mower body in general is not damaged or excessively worn. Always replace a damaged or worn out part, of which there are sets on the machine, with an entire set to prevent imbalance.

## OPERATION

- ✿ Only operate the machine during daylight or sufficient artificial lighting.
- ✿ If possible, do not mow wet grass.
- ✿ Make sure that during work you always have a firm support and a secure stance.
- ✿ Do not run when pushing the mower - walk normally.
- ✿ The following general rules apply for work with the lawn mower: When mowing on a slope, do not move up and down but always along the contours, i.e. horizontally perpendicular to the incline of the slope.
- ✿ Be very careful when changing direction on a slope.
- ✿ Never use the lawn mower on extremely steep slopes.



- ✿ If you need to pull the lawnmower towards you while it is running or if you need to move backwards with the lawnmower, be very careful.
- ✿ Always stop the blades from turning when transporting the machine or moving over an un-grassed area.
- ✿ Never use the machine if any covers are damaged or if any of its safety elements are missing such as deflectors or grass catchers.
- ✿ Always start the motor as described in the user manual, and make sure to keep your feet away from the blades.
- ✿ Never fill the machine when starting the motor unless it is really essential to start it. In this case, turn the side of the lawnmower that is farther away from you upwards.
- ✿ Never put your hands or feet under the lawnmower, in particular near to the moving parts. Never cover the grass ejection chute.
- ✿ Never transport the machine if the motor is still running.
- ✿ Always stop the motor first and disconnect the cable plug before troubleshooting or emptying the grass catcher.
  - Proceed in the same way before every inspection, cleaning or repair of the machine.
  - If you hit a foreign body make sure the lawnmower has not been damaged, and if it has repair the damage before starting the motor again.
  - Or if the machine starts to vibrate more than unusual (immediately check the machine!)
- ✿ Stop the motor whenever you move away from the machine.

## **MAINTENANCE AND STORAGE**

- ✿ Always make sure that all nuts, pins and bolts are securely tightened so that the machine operates safely.
- ✿ Regularly check the grass catcher for damage or excessive wear and tear.
- ✿ Immediately replace worn out or damaged parts. This will help your lawnmower to operate safely.
- ✿ When setting adjustable elements, take care not to clamp your fingers between the moving blades and the fixed part of the machine. Let the motor cool down before storing the lawnmower in an enclosed area.

## 5. ASSEMBLY

Assembly is simple if you follow the instructions below:

### 5.1 HANDLE

- ✿ Connect the top and bottom part of the handle using the included screws and nuts with quick coupler levers. Figure 2.1.
- ✿ Connect the bottom part of the handle to the lawnmower. Figure 2.2.
- ✿ Attach the power cord to the handle using the plastic clips.

#### Note:

- The handle is height-adjustable and can be folded down for storage.

### 5.2 WHEEL ATTACHMENT

- ✿ Put the lawnmower wheel on to the axle. Figure 3.1, pos. 1. Put on the washer and secure in place using the cotter pin. Figure 3.1, pos. 2 and 3. Finally put on the wheel cover. Repeat this procedure for all 4 wheels.

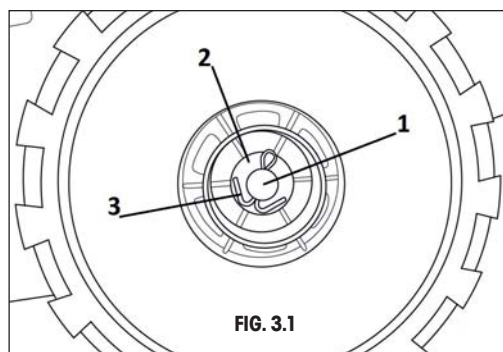
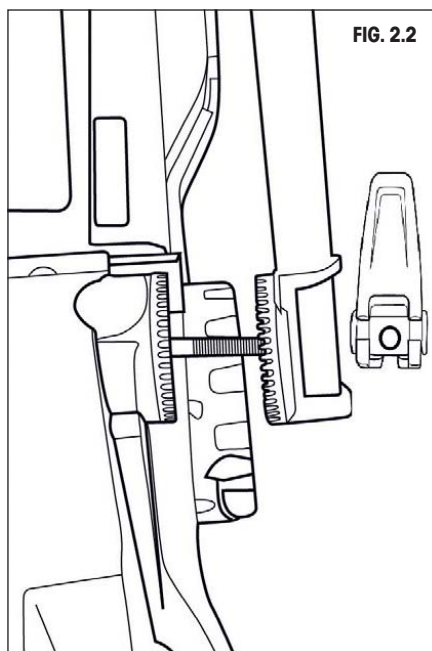
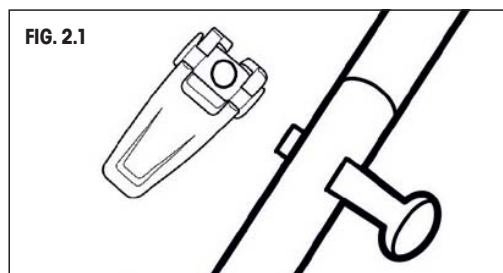

### 5.3 ASSEMBLING AND MOUNTING THE GRASS CATCHER.

- ✿ Insert the handle into the grass catcher cover. See Fig. 4.1.
- ✿ Mount textile part on the cap of catcher and the frame. Fig 4.2.
- ✿ Fitting the grass catcher: Lift the rear cover, keep it lifted and attach the catcher.

 **Note:** The lawnmower can be used without the grass catcher. The safety cover in the vertical position then directs the grass clippings. They are lined up in the following way behind the lawn mower.

### 5.4 EXTENSION CABLE / SECURING THE POWER CABLE

Insert the lawnmower plug into the socket on the power cable. To prevent the power cable from disconnecting during operation, guide it through the power cable holder.

FIG. 4.1

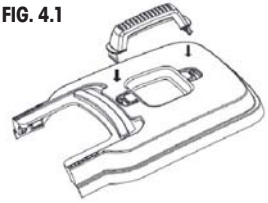
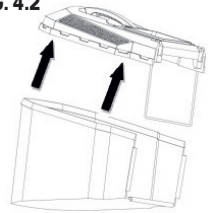

FIG. 4.2



## 6. OPERATION

### 6.1 SETTING THE MOWING HEIGHT

! Before setting the mowing height, always make sure that the lawn mower is turned off and the blade is not moving.

**⚠ ATTENTION:** The blade will rotate for several seconds after the lawn mower is turned off. A rotating blade can cause injuries.

The lawnmower has central mowing height adjustment with 6 settings from 25 - 75 mm.

Select the mowing height by moving the lever to the required position. (push the lever outwards, move it to the correct position, push inwards to fasten it. See Fig. 5.

**📖 Note:** Lawns of standard grass blends should not be mowed to less than 4 cm. Lawns should not be cut by more than 1/3 of their height.

### 6.2 SETTING THE HANDLE HEIGHT

The handle height can be set to your needs.

Release the clamping levers (fig.1, point 8) on both handle sides.

Set the required height of the handle by moving it up or down. Then secure with the quick clamping levers.

### 6.3 CONNECTING TO THE ELECTRICITY.

Insert the power cable plug into the power grid (230-240 V, 50 Hz).

Check that there is enough power cable available.

### 6.4 TURNING THE LAWN MOWER ON/OFF

#### 6.4.1 Turning it on:

Press and hold the safety button, see Fig. 6, point 1, pull the switch lever to the handle, see Fig. 6, point 2. Release the safety button.

#### 6.4.2 Turning it off:

Release the switching lever, see Fig. 6, point 2

**⚠ ATTENTION:** The blade will rotate for several seconds after the lawn mower is turned off.

**⚠ ATTENTION:** Do not turn the lawn mower off and on in quick succession.

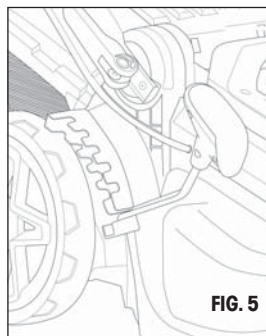

## 7. TECHNICAL SPECIFICATIONS

Model	FZR 2048 E
Power source	230-240 V, 50 Hz
Power input	2000 W
Idling speed	3550 rpm
Coverage width (blade length):	420 mm
Mowing heights	25-75 mm (6 positions)
Grass catcher volume	48 l
Weight when empty:	12.5 Kg
Noise level	
LpA (acoustic pressure)	82.4 dB(A) K=3 dB(A)
LwA (acoustic power level)	89.5 dB(A) K= 1.80dB(A)
Guaranteed emission level of acoustic power (LWA max) in accordance with the Noise Level Directive 2000/14:	
LwA MAX	95 dB (A)
Vibrations:	max. 2.17 m/s <sup>2</sup> K=1.5 m/s <sup>2</sup>

## 8. TROUBLESHOOTING

PROBLEM	POSSIBLE CAUSE	SOLUTION
The handle is not in the correct position	The handle fixing screws are not correctly mounted.  The mower handle joining screws are not tight.	Adjust the height of the handle and make sure the screws in the pre-bored holes are mounted correctly.  Tighten the joining screws.
The mower does not work.	The extension cable is not connected to the mower socket.  The extension cable is not connected to the electric socket.  The control trigger is defective.	Connect the cable again and use a cable limiter to keep the cable near the trigger. Connect the extension cable to a live socket. Have the engine control trigger replaced by an authorized service centre.
The mower cuts grass unequally.	The lawn is ragged or bumpy. The mowing height is not set properly.	Check the mowing area. Move the float to a higher position.
The mower does not mulch properly.	Wet grass is stuck on the bottom of the plate.	Wait until the grass is dry before mowing.
It is difficult to push the mower.	The grass is long or the mowing height is too low.	Increase the mowing height.
The mower vibrates at high speeds.	The engine shaft is bent.  The blade is not balanced.	Stop the engine, disconnect the mower from the electricity and check that it is not damaged. Repair the mower before starting it again. If the vibrations continue, call the free client line.  Balance the blade evenly by grinding each cutting edge.

## 9. MAINTENANCE

**⚠ ATTENTION!** Before removing the grass catcher, always turn off the lawn mower and pull the extension cable plug out of the power socket.

**📖 Note:** We recommend regularly carrying out the maintenance below, this will increase the lifetime and reliability of the machine.

- ✿ Regularly visually inspect the machine for defects such as a loose blade, blade installed upside down, blade damage or damaged or excessively worn parts.
- ✿ Also regularly check that the protective covers and protective elements are not damaged and are properly placed.
- ✿ Before using the machine, carry out all necessary repairs and maintenance.
- ✿ If, despite regular maintenance, the machine does not work, please contact our customer service, the repair should be carried out by our contractual partner in one of the specialised Fieldmann workshops.

### 9.1 BLADE REPLACEMENT

Contact an authorised service centre.  
Always use original spare parts.

**Before inspecting the blade, always disconnect the lawn mower from the electricity and check that the motor is turned off.**

**⚠ ATTENTION:** Remember that the blade still rotates for several seconds after the motor is turned off. Never attempt to stop the blade. Regularly check that the blade is securely fastened, in good condition and sharp. If necessary, sharpen or replace it.

If the blade hits an object while mowing, turn the lawnmower off and wait until the blade stops. Then check the condition of the blade and its fastening bolts.

If these are damaged or lost they must be replaced immediately.

**Important: Use protective gloves when working.**

Loosen the bolt holding the blade (using the appropriate wrench) by turning anticlockwise, remove the blade and replace it with a new one. Check that the new blade is installed in the correct direction. Tighten the bolt by turning it clockwise.

## 10. DISPOSAL

### INSTRUCTIONS AND INFORMATION ON DISPOSING OF USED PACKAGING MATERIALS

Dispose of used packaging material at a waste site in your municipality.

### DISPOSING OF USED ELECTRICAL AND ELECTRONIC EQUIPMENT



This symbol on products or original documents means that used electric or electronic products must not be added to ordinary municipal waste. Take these products to authorized collection points for proper disposal, renewal and recycling. Or in some European Union states or other European countries the products can be returned to the local retailer when buying an equivalent new product. Disposing of this product correctly helps save valuable natural resources and prevents damage to the environment by improper waste disposal. Ask your local authorities or collection facility for more details. In accordance with national regulations penalties may be imposed for the incorrect disposal of this type of waste.

#### For business entities in European Union states

If you want to dispose of electric or electronic appliances, ask your retailer or supplier for the necessary information. Disposal in other countries outside the European Union. This symbol is valid in the European Union. If you want to dispose of this product, get the necessary information from the local council or your retailer.



This appliance meets all the basic requirements of the EU directives.

The text, design and technical specifications can be changed without prior notice and we reserve the right to make these changes.

User manual in the original language.







 **FIELDMANN**<sup>®</sup>  
Home & Garden Performance